

Attrezzature per indirizzo Alberghiero

Lampade riscaldanti | Sterilizzatori universali | Carrelli e mobili di servizio in legno



Linea
Pluriservice

Visita il nostro store



www.mydidactstore.it

another way to care





Identità di Gruppo

“Lavoriamo con passione per lo sviluppo di soluzioni innovative.”

ABINTRAX è un'azienda impegnata nello sviluppo di prodotti e soluzioni professionali utilizzate nel campo della didattica e dell'assistenza clinica alla persona.

L'esperienza acquisita negli anni, insieme alla maturità e alla consapevolezza di dover affrontare i mercati con grande entusiasmo, hanno portato un nutrito gruppo di professionisti, derivanti da diverse esperienze in campo tecnologico, ad evolversi in una realtà nuova che trae la sua forza dalla spiccata spinta innovativa e dalla ricerca di soluzioni tecnologiche performanti.

Cuore dell'azienda è il reparto per la ricerca e lo sviluppo di nuovi prodotti hardware e software, integrate in soluzioni ad alto contenuto tecnologico.



Le nostre principali competenze specifiche sono:



SYSTEMS INTEGRATION

Creazione di infrastrutture e reti informatiche che consentono l'interazione e l'interconnessione tra diverse tecnologie

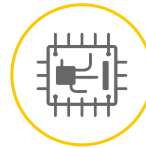

HARDWARE DESIGN

Progettazione, sviluppo e produzione di componenti hardware, circuiti integrati e apparecchiature elettroniche



SOFTWARE DESIGN

Progettazione e sviluppo industriale di applicativi e soluzioni software ad uso professionale

Organizzazione aziendale

Divisione R&S | Regulatory affairs | Ufficio Gare | Uffici commerciali | Uffici operativi di commessa | Support & Customer care | Laboratori e Magazzini.

Responsabili aziendali di area

Area 1 – Sig. Pietro: p.rosato@didact.abintrax.com

mobile 351 0419612 (anche  WhatsApp) Calabria, Puglia, Basilicata, Campania, Sicilia

Area 2 – Sig. Vito: v.cito@abintrax.com

mobile 345 0322557 (anche  WhatsApp) Lombardia, Veneto, Friuli, Toscana, Emilia Romagna, Umbria, Trentino Alto Adige, Valle D'Aosta

Area 3 – Sig.ra Rosalia: r.defelice@abintrax.com

mobile 344 0774237 (anche  WhatsApp) Lazio, Abruzzo, Marche, Sardegna, Molise, Liguria, Piemonte

La Nostra Storia

ABINTRAX, dal latino Ab Intra, nasce appunto "dall'interno" di realtà scafate con elevatissima esperienza, affermate e leader in mercati tecnologici. Fonde insieme competenze e professionalità di altissima specializzazione per offrire soluzioni in linea con le dinamiche e le esigenze del mercato ormai globalizzato. Cuore dell'azienda è il reparto per la ricerca e lo sviluppo di nuovi prodotti con esperienza in ambito di sviluppo software e di dispositivi hardware e soluzioni ad alto contenuto tecnologico.

Mission

«Lavoriamo con passione per lo sviluppo di soluzioni innovative capaci di consentire il superamento delle disparità economiche e sociali attraverso uno sviluppo tecnologico sostenibile. Siamo fortemente impegnati a mettere la nostra esperienza a servizio della comunità in modo efficace ed efficiente, migliorando le prestazioni e il valore fornito ai nostri stakeholder.»
Abintrax è alla continua ricerca di soluzioni e tecnologie innovative capaci di migliorare i propri prodotti, per offrire le migliori soluzioni per i propri partner.

Vision

Crediamo fermamente che il progresso, la tecnologia e l'innovazione devono essere al servizio dei cittadini e della comunità. Lavoriamo per sviluppare strumenti tecnologici sostenibili in grado di colmare le differenze e ridurre le distanze al fine di poter contribuire alla creazione di servizi eccellenti per le persone e per migliorare la qualità della vita. Abintrax continuerà a sostenere lo sviluppo di una comunità attiva che investe nelle persone, per le persone.

Ogni prodotto dispone di scheda tecnica e relative certificazioni. Ogni ulteriore utile informazione può essere richiesta tramite posta elettronica all'indirizzo email commerciale@didact.abintrax.com

Tutti i prodotti sono disponibili per ordini sulla piattaforma MePA

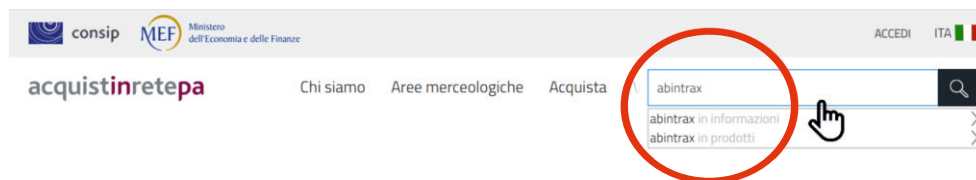

Distributore esclusivo dei marchi



Alcuni tra i nostri principali partner























icone

	IT	EN	FR	DE
	INFORMAZIONI	INFORMATION	INFORMATION	INFO
	NUMERO PIANI	NUMBER OF SHELVES	NOMBRE D'ÉTAGÈRES	STELLFLÄCHENANZAHL
	CARICO MASSIMO	MAXIMUM LOAD	CHARGE MAXIMALE	MAXIMALE BELASTUNG
	DIMENSIONI MACCHINA	MACHINE DIMENSIONS	DIMENSIONS DES MACHINES	MASCHINEN ABMESSUNGEN
	POTENZA	POWER	PUISSANCE	LEISTUNG
	PIASTRE/FUOCHI	PLATES/BURNERS	CUSINIÈRES/BRÔLEURS	KOCHFLÄCHEN/KOCHSTELLEN
	DIMENSIONI DEL PIANO DI LAVORO	DIMENSIONS OF THE WORKTOP	DIMENSIONS DU PLAN DE TRAVAIL	ABMESSUNGEN DER ARBEITSPLATTE
	NUMERO VASCHE	NUMBER OF BOWLS	NOMBRE DE CUVES	ANZAHL DER WANNEN
	ALIMENTAZIONE MONOFASE	SINGLE-PHASE POWER SUPPLY	ALIMENTATION MONOPHASÉE	EINPHASIGE STROMVERSORGUNG
	TEMPERATURA DI LAVORO	WORKING TEMPERATURE	TEMPÉRATURE DE FONCTIONNEMENT	BETRIEBSTEMPERATUR
	TIPO DI GAS	TYPE OF GAS	TYPE DE GAZ	GASTYP
	NUMERO DI TEGLIE	NUMBER OF TRAYS	NOMBRE DE PLAQUES	ANZAHL DER BLECHE
	NUMERO PIATTI	NUMBER OF PLATES	NOMBRE DE PLATS	ANZAHL DER TELLER
	CAPACITÀ DEL CONTENITORE	CONTAINER CAPACITY	CAPACITÉ DU CONTENANT	BEHÄLTERKAPAZITÄT



indice

CATEGORIE	IT	EN	FR	DE	
CARRELLI E MOBILI DI SERVIZIO IN LEGNO	CARRELLI GUÉRIDON	GUÉRIDON TROLLEYS	CHARIOTS GUÉRIDON	GUÉRIDON WAGEN	13
WOODEN SERVICE TROLLEYS AND SERVING FURNITURE	CARRELLI DI SERVIZIO IN LEGNO	WOODEN SERVICE TROLLEYS	CHARIOTS DE SERVICE EN BOIS	SERVIERWAGEN AUS HOLZ	15
CHARIOTS ET MEUBLES DE SERVICE EN BOIS	CARRELLI FLAMBÈ	FLAMBÈ TROLLEYS	CHARIOTS FLAMBÉS	FLAMBÉ WAGEN	25
SERVIERWAGEN UND SERVICEMÖBEL AUS HOLZ	MOBILI DI SERVIZIO IN LEGNO	WOODEN SERVING FURNITURE	MEUBLES DE SERVICE EN BOIS	SERVICEMÖBEL AUS HOLZ	27
CARRELLI DI SERVIZIO IN ACCIAIO INOX AISI 304	CARRELLI DI SERVIZIO IN ACCIAIO INOX E RIPIANI IN NOBILITATO	STAINLESS STEEL SERVICE TROLLEYS WITH SHELVES MADE OF MELAMINE	CHARIOTS DE SERVICE ET ÉTAGÈRES EN ACIER INOX EN MÉLAMINE	SERVIERWAGEN AUS EDELSTAHL MIT ABLAGEN AUS MELAMINHARZ	37
SERVICE TROLLEYS IN STAINLESS STEEL AISI 304	CARRELLI DI SERVIZIO IN ACCIAIO INOX	STAINLESS STEEL SERVICE TROLLEYS	CHARIOTS DE SERVICE EN ACIER INOX	SERVIERWAGEN AUS EDELSTAHL	39
CHARIOTS DE SERVICE EN ACIER INOX AISI 304	CARRELLI DI SERVIZIO MULTIUSO IN PLASTICA	MULTIPURPOSE PLASTIC SERVICE TROLLEYS	CHARIOTS POLYVALENTE EN PLASTIQUE	MEHRZWECK-SERVIERWAGEN AUS KUNSTSTOFF	49
SERVIERWAGEN AUS EDELSTAHL AISI 304	CARRELLI REFRIGERATI IN LEGNO	WOODEN REFRIGERATED TROLLEYS	CHARIOTS RÉFRIGÉRÉS EN BOIS	GEKÜHLTE SERVIERWAGEN AUS HOLZ	51
CARRELLI ED ESPOSITORI REFRIGERATI E TERMICI IN LEGNO	ESPOSITORI REFRIGERATI IN LEGNO	WOODEN REFRIGERATED DISPLAYS	VITRINES RÉFRIGÉRÉES EN BOIS	GEKÜHLTE VITRINE AUS HOLZ	54
WOODEN THERMAL AND REFRIGERATED TROLLEYS AND DISPLAYS	CARRELLI TERMICI A BAGNOMARIA IN LEGNO	WOODEN BAIN-MARIE TROLLEYS	CHARIOTS CHAUDES BAIN-MARIE EN BOIS	BAIN-MARIE WAGEN AUS HOLZ	57
CHARIOTS ET VITRINES RÉFRIGÉRÉS ET CHAUFFÉS EN BOIS	ESPOSITORI TERMICI A BAGNOMARIA IN LEGNO	WOODEN HEATED BAIN-MARIE DISPLAYS	VITRINES CHAUDES BAIN-MARIE EN BOIS	BEHEIZTE BAIN-MARIE VITRINE AUS HOLZ	61
GEKÜHLTE UND BEHEIZTE SERVIERWAGEN UND VITRINEN AUS HOLZ	ESPOSITORI IN LEGNO NEUTRO	DISPLAYS IN NEUTRAL WOOD	VITRINES EN BOIS NEUTRE	AUFSATZVITRINEN AUS NEUTRALEM HOLZ	64
	CARRELLO TERMICO, IDEALE PER BOLLITI E ARROSTI	HEATED TROLLEYS, IDEAL FOR BOILED AND ROASTED MEATS	CHARIOTS CHAUFFANTS, IDÉAUX POUR BOUILLIR ET RÔTIR	BEHEIZTE SERVIERWAGEN, IDEAL FÜR GEKOCHTES UND GEBRATENES FLEISCH	64
	MENSOLE IN LEGNO PER UNIONE	CONNECTION WOODEN SHELF	ÉTAGÈRES EN BOIS POUR RACCORDS	VERBINDUNGSREGALE AUS HOLZ	66
CARRELLI REFRIGERATI E TERMICI, VASCHE DA INCASSO, DISTRIBUTORI PRIMA COLAZIONE, IN ACCIAIO INOX	VASCHE REFRIGERATE IN ACCIAIO INOX (DROP-IN)	STAINLESS STEEL REFRIGERATED BOWLS (DROP-IN)	CUVES RÉFRIGÉRÉES EN ACIER (A POSER)	KÜHLWANNEN AUS EDELSTAHL (DROP-IN)	69
REFRIGERATED AND HEATED TROLLEYS, BUILT-IN BOWLS, BREAKFAST DISPENSERS, MADE OF STAINLESS STEEL	VASCHE TERMICHE A BAGNOMARIA IN ACCIAIO INOX	STAINLESS STEEL HEATED BAIN-MARIE BOWLS	CUVES BAIN-MARIE EN ACIER INOX	BAIN-MARIE HEIZWANNEN AUS EDELSTAHL	70
CHARIOTS RÉFRIGÉRÉS ET CHAUFFÉS, BACS INTÉGRÉS, DISTRIBUTEURS DE PETIT DÉJEUNER, EN ACIER INOX	CARRELLI REFRIGERATI IN ACCIAIO INOX	REFRIGERATED STAINLESS STEEL TROLLEYS	CHARIOTS RÉFRIGÉRÉS EN ACIER INOX	GEKÜHLTE SERVIERWAGEN AUS EDELSTAHL	71
GEKÜHLTE UND BEHEIZTE SERVIERWAGEN, EINGebaUTE BEHÄLTER, FRÜHSTÜCKSSPENDER, AUS EDELSTAHL	CARRELLI TERMICI IN ACCIAIO INOX	HEATED STAINLESS STEEL TROLLEYS	CHARIOTS CHAUFFANTS EN ACIER INOX	BEHEIZTE SERVIERWAGEN AUS EDELSTAHL	72
	DISTRIBUTORI PRIMA COLAZIONE IN ACCIAIO INOX	STAINLESS STEEL BREAKFAST DISPENSERS	DISTRIBUTEURS DE PETIT DÉJEUNER EN ACIER INOX	FRÜHSTÜCKSSPENDER SERVIERWAGEN AUS EDELSTAHL	80

CATEGORIE	IT	EN	FR	DE	
ELEMENTI RISCALDANTI E VETRINE NEUTRE	TAVOLE CALDE	HEATED TABLES	TABLES CHAUDES	BEHEIZTE TISCHE	83
	PIANI CALDI	HEATED TOPS	PLANS DE TRAVAIL CHAUDS	BEHEIZTE ARBEITSFLÄCHE	86
HEATING ELEMENTS AND NEUTRAL DISPLAYS	LAMPADE A RAGGI INFRAROSSI	INFRARED LAMPS	LAMPES INFRAROUGES	INFRAROT-LAMPEN	87
	VETRINE RISCALDANTI	HEATED DISPLAYS	VITRINES CHAUFFÉES	BEHEIZTE VITRINEN	90
ELÉMENTS CHAUFFANTS ET VITRINES NEUTRES	VETRINE NEUTRE	NEUTRAL DISPLAYS	VITRINES NEUTRES	NEUTRALE VITRINEN	91
	MOBILETTI SCALDAPIATTI	PLATES HEATING CABINETS	ARMOIRES CHAUFFE-PLATS	TELLERWÄRMER	94
HEIZELEMENTE UND NEUTRALE VITRINEN	VETRINE RISCALDANTI CON GRIGLIE	HEATED DISPLAY CASES WITH GRIDS	VITRINES CHAUFFÉES AVEC GRILLES	BEHEIZTE VITRINEN MIT GITTER	95
	CARRELLI PORTAVASSOI GN	GN TRAY TROLLEYS	CHARIOTS À PLATEAUX GN	SERVIERWAGEN FÜR GN PLATTEN	97
CARRELLI PER LA CUCINA	CARRELLI PORTAVASSOI UNIVERSALI	UNIVERSAL TRAY TROLLEYS	CHARIOTS À PLATEAUX UNIVERSELS	UNIVERSAL SERVIERWAGEN	100
KITCHEN TROLLEYS	CARRELLI PORTATEGLIE GN	GASTRONOM GN PANS TROLLEYS	CHARIOTS À PLAQUES GN	SERVIERWAGEN FÜR GASTRONOMIE GN BLECHE	102
CHARIOTS POUR LA CUISINE	CARRELLI PORTATEGLIE PER PASTICCERIA	PASTRY PANS TROLLEY	CHARIOTS POUR PLAQUES DE PÂTISSERIE	SERVIERWAGEN FÜR KONDITOREI BLECHE	104
KÜCHENWAGEN	PORTAPIATTI DA BANCO, PORTAPIATTI DA PARETE E CARRELLI	TABLE TOP PLATE RACK, WALL PLATE RACK AND TROLLEYS	ÉTAGÈRE À ASSIETTES DE TABLE, PORTE-ASSIETTES À MURO ET CHARIOTS	TISCH-TELLERSTÄNDER, WANDTELLERHALTER. UND TELLERWAGEN	107
CARRELLI PORTAPIATTI E CESTELLI	CARRELLI PORTAPIATTI ARMADIATI	CABINET PLATE TROLLEYS	CHARIOTS PORTE-ASSIETTES SUR ÉLÉMENT FERMÉ	TELLERWAGEN MIT SCHRANKELEMENT	110
	CARRELLI PORTAPIATTI RISCALDATI	HEATED PLATE STORAGE TROLLEYS	CHARIOTS CHAUFFÉS À ASSIETTES	BEHEIZTE TELLERWAGEN	111
PLATE AND BASKETS TROLLEYS	CARRELLI PORTAPIATTI REFRIGERATI	REFRIGERATED PLATE STORAGE TROLLEYS	CHARIOTS RÉFRIGÉRÉS À ASSIETTES	GEKÜHLTE TELLERWAGEN	112
CHARIOTS POUR PANIERS ET ASSIETTES	CARRELLI PORTAPIATTI PER TRASPORTO E RITIRO	PLATES TRANSPORT AND COLLECTION TROLLEYS	CHARIOTS DE COLLECTE, DE DISTRIBUTION ET DE STOCKAGE DE PLATEAUX	WAGEN ZUM SAMMELN, VERTEILEN UND LAGERN VON TABLETTS	113
SERVIERWAGEN FUER TELLER UND KÖRBE	SCOLAPIATTI E BICCHIERI	PLATE AND GLASSES DRAINER	ÉGOUTTOIR POUR VERRES ET ASSIETTES	HÄNGE-ABTROPFER FÜR TELLER UND GLÄSER	113
	CARRELLI PORTACESTELLI	BASKET TROLLEYS	CHARIOT À PANIERS	KORBWAGEN	114
CARRELLI PORTACASSETTE PER IMPASTI PIZZA	TROLLEY FOR PIZZA DOUGH CONTAINERS	CHARIOT À BACS POUR PÂTE À PIZZA	WAGEN FÜR PIZZATEIGBEHÄLTER	116	
CESTELLI PER LAVASTOVILIE	DISHWASHER BASKETS	PANIERS POUR LAVE-VAISSELLE	KÖRBE FÜR GESCHIRRSPÜLER	117	
CARRELLI E ARTICOLI PER IL SERVIZIO IN CAMERA	CARRELLI PER LA COLAZIONE/BREAKFAST TROLLEYS		CHARIOTS DE PETIT DÉJEUNER	FRÜHSTÜCKSWAGEN	119
	CARRELLI PORTAVALIGIE E PORTABITI	LUGGAGE TROLLEYS AND CLOTHES RACKS	CHARIOTS À BAGAGES ET PORTE-VÊTEMENTS	KOFFERWAGEN UND KLEIDERSTÄNDER	121
TROLLEYS AND EQUIPMENT FOR ROOM SERVICE	REGGI VALIGIE	LUGGAGE HOLDER	SUPPORTS DE BAGAGES	KOFFERTRÄGER	125
CHARIOTS ET ARTICLES POUR LE ROOM SERVICE	CARRELLI PER TRASPORTO PESANTE	TROLLEYS FOR HEAVY TRANSPORT	CHARIOTS POUR CHARGES LOURDES	WAGEN FÜR DEN SCHWERTRANSPORT	126
WAGEN UND AUSRÜSTUNG FÜR DEN ZIMMERSERVICE	ASTA DELIMITA CORSIA	RETRACTABLE BARRIERS	DÉLIMITEUR DE ZONE	BEGRENZUNG	127
	MACCHINE PULISCI SCARPE	SHOE CLEANER MACHINE	MACHINE DE NETTOYAGE DE CHAUSSURES	SCHUHPUTZMASCHINE	129

CATEGORIE	IT	EN	FR	DE	
CARRELLI PORTABIANCHERIA, RIFORNIMENTO FRIGOBAR, PULIZIA E MULTIUSO LAUNDRY, MINIBAR, CLEANING AND MULTI-PURPOSE TROLLEYS CHARIOTS À LINGE, RECHARGE MINIBAR, NETTOYAGE ET POLYVALENT WÄSCHEREI-, MINIBAR-, REINIGUNG- UND MEHRZWECKWAGEN	CARRELLI PORTABIANCHERIA	LAUNDRY TROLLEYS	CHARIOTS À LINGE	WÄSCHEWAGEN	131
	CARRELLI PER RIFORNIMENTO FRIGOBAR	TROLLEYS FOR MINI-BAR REFUELLING	CHARIOTS DE REMPLISSAGE POUR MINIBARS	WAGEN FÜR DIE MINIBARFÜLLUNG	134
	CESTONE E CARRELLI CON CESTO PER BIANCHERIA	BASKET AND TROLLEYS WITH LAUNDRY BASKET	PANIERI ET CHARIOTS AVEC PANIER À LINGE	KORB UND WAGEN MIT WÄSCHEKORB	135
	CARRELLI PER PULIZIA	CLEANING TROLLEYS	CHARIOTS DE NETTOYAGE	REINIGUNGSWAGEN	136
	CARRELLO MULTIUSO IN PLASTICA	MULTI-PURPOSE PLASTIC TROLLEY	CHARIOT POLYVALENT EN PLASTIQUE	MEHRZWECK- KUNSTSTOFFWAGEN	140
ARTICOLI VARI PER LA MACELLERIA ITEMS FOR THE MEAT PROCESSING ARTICLES POUR LA TRANSFORMATION DE LA VIANDE ARTIKEL FÜR DIE FLEISCHVERARBEITUNG	LAVAMANI	HAND WASHER	LAVE-MAINS	HANDWÄSCHER	143
	STERILIZZATORI ELETTRICI PER COLTELLI	ELECTRIC STERILIZERS FOR KNIVES	DISPOSITIFS ÉLECTRIQUES DE DÉSINFECTION POUR COUTEAUX	ELEKTRISCHE ENTKEIMUNGSGERÄTE FÜR MESSER	145
	GREMBIULI E GUANTI	APRONS AND GLOVES	TABLIERS ET GANTS	SCHÜRZEN UND HANDSCHUHE	146
	CEPPI	BUTCHER BLOCKS	BLOCS DE BOUCHERIE	METZGERBLOCKS	147
	TAGLIERI E RASCHIETTO	CUTTING BOARDS AND SCRAPER	PLANCHES À DÉCOUPER ET RACLOIR	SCHNEIDEBRETTER UND ABSTREIFER	149
	SCAFFALATURA MODULARE	MODULAR SHELVING	RAYONNAGE MODULAIRE	MODULAR REGALE	150
	ELETTROINSETTICIDI	ELECTRO-INSECTICIDES	ELECTRO-INSECTICIDES	ELEKTROINSEKT-KILLER	151
ATTREZZATURA PER LA COLAZIONE BREAKFAST EQUIPMENT ÉQUIPEMENT DE PETIT-DÉJEUNER FRÜHSTÜCKSAUSRÜSTUNG	CHAFING DISHES	CHAFING DISHES	CHAFING DISHES	CHAFING DISHES	153
	ZUPPIERA ELETTRICA	ELECTRIC SOUP TUREEN	SOUPIÈRE ÉLECTRIQUE	ELEKTRISCHE SUPPENSCHÜSSEL	156
	DISTRIBUTORI CAFFÈ, BEVANDE E CEREALI	COFFEE, DRINKS AND CEREALS DISPENSERS	DISTRIBUTEURS DE CAFÉ, DE BOISSONS ET DE CÉRÉALES	KAFFEE-, GETRÄNKE- UND MÜSLISPENDER	156
	FORNELLO FLAMBÈ	FLAMBÉ COOKER	CUISIÈRE FLAMBÉE	FLAMBÉ GASHERD	158
	PADELLA FLAMBÈ	FLAMBÉ PAN	CASSEROLE À FLAMBER	FLAMBIERPANNE	158
ARTICOLI VARI PER CUCINA E PIZZERIA ITEMS FOR COOKING AND PIZZERIA ARTICLES POUR LA CUISINE ET POUR LA PIZZERIA KOCH- UND PIZZERIAARTIKEL	BACINELLE, TEGLIE, VASCHE PER GELATO, VASSOI, APRISCATOLE, MORSA PER PROSCIUTTO, SPATOLE, PALETTE, PINZE, ROTELLE, TAGLIERI, CONTENITORI IMPASTI PER PIZZA, BALANCE	CONTAINERS, PANS, ICE CREAM CONTAINERS, TRAYS, CAN OPENERS, HAM CLAMPS, SPATULAS, SLIDES, CLAMPS, ROLLS, CHOPPING BOARDS, PIZZA DOUGH CONTAINERS, SCALES	BACS, PLAQUES, BACS À CRÈME GLACÉE, PLATEAUX, OUVRE-BOÎTES, OUVRE- BOÎTES, ÉTAU À JAMBON, SPATULES, PALETTES, PINCES, ROUES, PLANCHES À DÉCOUPER, RÉCIPENTS À PÂTE DE PIZZA, BALANCES	BEHÄLTER, BLECHE, EISBEHÄLTER, SCHALEN, DOSENÖFFNER, SCHINKENKLAMMERN, SPATEL, SCHAUFELN, KLAMMERN, ROLLEN, SCHNEIDEBRETTER, PIZZATEIGBEHÄLTER, WAAGEN	161
PATTUMIERE-PORTARIFIUTI GARBAGE AND DUST BINS POUBELLES MÜLL- UND ABFALLBEHÄLTER	PATTUMIERE-PORTARIFIUTI	GARBAGE AND DUST BINS	POUBELLES	MÜLL- UND ABFALLBEHÄLTER	177
CONDIZIONI GENERALI DI VENDITA	GENERAL SALES CONDITIONS	CONDITIONS GÉNÉRALES DE VENTE	ALLGEMEINE VERKAUFSBEDINGUNGEN		182



Carrelli e mobili di servizio in legno



ABX-CA9012R

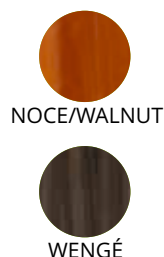

ABX-CA901

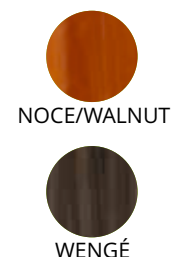

IT Carrelli Guéridon. Struttura portante in tubo di acciaio inox AISI 304 - ripiani in nobilitato con bordo in gomma - carrelli disponibili nei colori noce e wengé - 2 ruote multidirezionali ø 95 mm.

EN Guéridon trolleys. Tubular stainless steel AISI 304 supporting structure - melamine shelves with rubber edges - trolleys available in walnut and wenge colour - 2 multidirectional wheels ø 95mm

FR Chariots Guéridon. Structure portante en tube d'acier inox AISI 304 - étagères en mélaminé avec bord en caoutchouc - chariots disponibles en noyer et wengé - 2 roues multidirectionnelles ø 95mm

DE Guéridon Wagen. Stützrahmen aus Edelstahlrohr AISI 304 - Regale aus Melamin mit Gummikante - Wagen in den Farben Nussbaum und Wenge erhältlich - 2 Mehrweg-Räder ø 95 mm

IT Carrelli Guéridon. Struttura portante in tubo di acciaio inox AISI 304 - ripiani in nobilitato con bordo in gomma - carrelli disponibili nei colori noce e wengé - 4 ruote multidirezionali ø 95 mm.

EN Guéridon trolleys. Tubular stainless steel supporting structure AISI 304 - melamine shelves with rubber edges - trolleys available in walnut and wenge colour - 4 multidirectional wheels ø 95 mm.

FR Chariots Guéridon. Structure portante en tube d'acier inox AISI 304 - étagères en mélaminé avec bord en caoutchouc - chariots disponibles en noyer et wengé - 4 roues multidirectionnelles ø 95 mm.

DE Guéridon Wagen. Stützrahmen aus Edelstahlrohr AISI 304 - Einlegeböden aus Melamin mit Gummikante - Wagen in den Farben Walnuss und Wenge erhältlich - 4 Mehrwegräder ø 95

	ABX-CA9012R noce-walnut	ABX-CA9012RW wengé
	70 x 50 x 78(h) cm	
	2	
	40 Kg	
	320 €	

	ABX-CA901 noce-walnut	ABX-CA901W wengé
	70 x 50 x 78(h) cm	
	2	
	40 Kg	
	340 €	

ABX-CL903

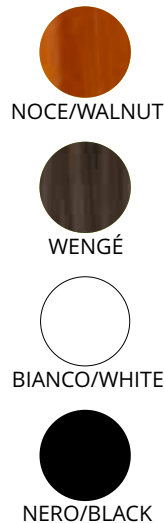

IT Carrelli Guéridon. Struttura portante in legno massello - ripiani in nobilitato con bordo in gomma - carrelli disponibili nei colori noce, wengé, bianco o nero - ruote multidirezionali ottonate ø 95 mm.

EN Guéridon trolleys. Solid wood supporting structure - melamine shelves with rubber edges - trolleys available in walnut, wenge, white or black colour - multidirectional brass-plated wheels ø 95 mm.

FR Chariots Guéridon. Structure portante en bois massif - étagères en mélaminé avec bord en caoutchouc - chariots disponibles en noyer, wengé, blanc ou noir - roues multidirectionnelles laitonées ø 95 mm.

DE Guéridon Wagen. Stützrahmen aus Massivholz- Einlegeböden aus Melamin mit Gummikante - Wagen in den Farben Walnuss, Wenge, Schwarz und Weiß erhältlich - messingbeschichtete Mehrwegräder ø 95 mm.

	ABX-CL903 noce-walnut	ABX-CL903W wengé	ABX-CL903B bianco-white	ABX-CL903N nero-black
	70 x 50 x 78(h) cm			
	2			
	40 Kg			
	335 €		620 €	

ABX-CLE



IT Carrelli Guéridon. Struttura in legno massello - ripiani in multistrato di betulla - disponibile nel colore noce - ruote multidirezionali ø 95 mm. Su richiesta disponibili altri colori RAL.

EN Guéridon trolleys. Solid wood structure - multi-layered birch shelves - available in walnut colour - multidirectional brass-plated wheels ø 95 mm. Further RAL colours available on request.

FR Chariots Guéridon. Structure en bois massif - étagères en multicouche de bouleau - disponible en couleur noyer - roues multidirectionnelles de ø 95 mm. Couleurs RAL disponibles sur demande.

DE Guéridon Wagen. Massivholzrahmen - Einlegeböden aus Birkensperrholz - erhältlich in Walnussfarbe - Mehrwegräder ø 95 mm. RAL-Farben auf Anfrage erhältlich.

	ABX-CLE noce-walnut	ABX-CLE ral
	90 x 45 x 77(h) cm	
	2	
	40 Kg	
	—	—



ABX-CLP2002



-  NOCE/WALNUT
-  WENGÉ
-  BIANCO/WHITE
-  NERO/BLACK

ABX-CLP2002L40



-  NOCE/WALNUT
-  WENGÉ

IT Carrelli di servizio in legno. Struttura in legno massello - ripiani in multistrato di betulla - maniglie di spinta integrate nel piano superiore - ringhiere di contenimento sui piani inferiori - carrelli disponibili nei colori noce, wengé, bianco e nero - ruote multidirezionali cromate ø 95 mm.

EN Wooden service trolleys. Solid wood structure - birch multi-layered wood shelves - integrated push handles in the upper shelf - retaining rails on the lower shelves - trolleys available in walnut, wengé, white and black colour - multidirectional chrome-plated wheels ø 95 mm.

FR Chariots de service en bois. Structure en bois massif - étagères en bouleau multicouche - poignées de poussée intégrées à l'étagère supérieur - profilés de retenue aux étagères inférieurs - chariots disponibles en noyer, wengé, blanc et noir - roues multidirectionnelles chromées ø 95 mm.

DE Servicewagen aus Holz. Massivholzstruktur - Ablageflächen aus Birkensperrholz - Schubgriffe eingebaut an der obersten Fläche - Halterungen in den untersten Etagen - Wagen in Nussbaum, Wenge, Weiß und Schwarz erhältlich - Mehrweg-Chromräder ø 95 mm.

IT Carrelli di servizio in legno. Struttura in legno massello - ripiani in multistrato di betulla - maniglie di spinta integrate nel piano superiore - carrelli disponibili nei colori noce e wengé - ruote multidirezionali cromate ø 95 mm.

EN Wooden service trolleys. Solid wood structure - birch multi-layered wood shelves - integrated push handles in the upper shelf - trolleys available in walnut and wengé colour - multidirectional chrome-plated wheels ø 95 mm.

FR Chariots de service en bois. Structure en bois massif - étagères en bouleau multicouche - poignées de poussée intégrées à l'étagère supérieur - p chariots disponibles en noyer et wengé - roues multidirectionnelles chromées ø 95 mm.

DE Servicewagen aus Holz. Massivholzstruktur - Ablageflächen aus Birkensperrholz - Schubgriffe eingebaut an der obersten Fläche - Wagen in Nussbaum und Wenge - Mehrweg-Chromräder ø 95 mm.

	ABX-CLP2002 noce-walnut	ABX-CLP2002W wengé	ABX-CLP2002B bianco-white	ABX-CLP2002N nero-black
	110 x 55 x 82(h) cm			
	2			
	80 Kg			
	710 €		870 €	

	ABX-CLP2002L40 noce-walnut	ABX-CLP2002L40W wengé
	110 x 40 x 82(h) cm	
	2	
	80 Kg	
	610 €	

ABX-CLP2003



ABX-CLP2003L40



- IT** Carrelli di servizio in legno. Struttura in legno massello - ripiani in multistrato di betulla - maniglie di spinta integrate nel piano superiore - ringhiere di contenimento sui piani inferiori - carrelli disponibili nei colori noce, wengé, bianco e nero - ruote multidirezionali cromate ø 95 mm.
- EN** Wooden service trolleys. Solid wood structure - birch multi-layered wood shelves - integrated push handles in the upper shelf - retaining rails on the lower shelves - trolleys available in walnut, wengé, white and black colour - multidirectional chrome-plated wheels ø 95 mm.
- FR** Chariots de service en bois. Structure en bois massif - étagères en bouleau multicouche - poignées de poussée intégrées à l'étagère supérieur - profilés de retenue aux étagères inférieurs - chariots disponibles en noyer, wengé, blanc et noir - roues multidirectionnelles chromées ø 95 mm.
- DE** Servicewagen aus Holz. Massivholzstruktur - Ablageflächen aus Birkenesperrholz - Schubgriffe eingebaut an der obersten Fläche - Halterungen in den untersten Etagen - Wagen in Nussbaum, Wenge, Weiß und Schwarz erhältlich - Mehrweg-Chromräder ø 95 mm.

- IT** Carrelli di servizio in legno. Struttura in legno massello - ripiani in multistrato di betulla - maniglie di spinta integrate nel piano superiore - carrelli disponibili nei colori noce e wengé - ruote multidirezionali cromate ø 95 mm.
- EN** Wooden service trolleys. Solid wood structure - birch multi-layered wood shelves - integrated push handles in the upper shelf - trolleys available in walnut and wengé colour - multidirectional chrome-plated wheels ø 95 mm.
- FR** Chariots de service en bois. Structure en bois massif - étagères en bouleau multicouche - poignées de poussée intégrées à l'étagère supérieur - chariots disponibles en noyer et wengé - roues multidirectionnelles chromées ø 95 mm.
- DE** Servicewagen aus Holz. Massivholzstruktur - Ablageflächen aus Birkenesperrholz - Schubgriffe eingebaut an der obersten Fläche - Wagen in Nussbaum und Wenge - Mehrweg-Chromräder ø 95 mm.

	ABX-CLP2003 noce-walnut	ABX-CLP2003W wengé	ABX-CLP2003B bianco-white	ABX-CLP2003N nero-black
	110 x 55 x 89(h) cm			
	3			
	80 Kg			
	940 €		1.170 €	

	ABX-CLP2003L40 noce-walnut	ABX-CLP2003L40W wengé
	110 x 40 x 89(h) cm	
	3	
	80 Kg	
	740 €	

ABX-CL2000



ABX-CLP2001

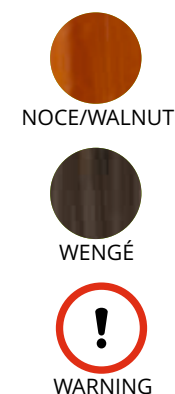

IT Carrelli di servizio in legno. Struttura in legno multistrato di betulla - ripiani in nobilitato - cornice perimetrale e maniglia in legno massello - disponibili nei colori noce e wengé - ruote multidirezionali di serie cromate ø 95 mm.

EN Wooden service trolleys. Birch multi-layered wood structure - melamine shelves - solid wood perimeter frame and handle - available in walnut and wenge colour - standard multidirectional chrome-plated wheels ø 95 mm.

FR Chariots de service en bois. Structure en bouleau multicouche - étagères en bois mélaminé - cadre périmétral et poignée en bois massif - disponible en noyer et wengé - de série roues multidirectionnelles chromées ø 95 mm.

DE Servicewagen aus Holz. Struktur aus Birkenspertholz - Regale aus melaminharzbeschichtetem Birkenholz - Zierrahmen und Griff aus Struktur aus Birkenfurnierholz - Ablagefläche aus Furnierholz - umlaufender Rahmen und Griff aus Massivholz - erhältlich in den Farben Nussbaum und Wenge - serienmäßig mit Mehrweg-Chromräder ø 95 mm.

	ABX-CL2000 noce-walnut	ABX-CL2000W wengé
		
	86 x 55 x 85(h) cm	
	2	
	80 Kg	
	750 €	

IT Carrelli di servizio in legno. Struttura in legno multistrato di betulla - ripiani in nobilitato - cornice perimetrale in legno massello - disponibili nei colori noce e wengé - ruote multidirezionali cromate ø 95 mm.

EN Wooden service trolleys. Birch multi-layered wood structure - melamine shelves - solid wood perimeter frame - available in walnut and wenge colour - multidirectional chrome-plated wheels ø 95 mm.

FR Chariots de service en bois. Structure en bouleau mélaminé - étagères en bois multicouche - cadre périmétral en bois massif - disponible en noyer et wengé - roues multidirectionnelles chromées ø 95 mm.

DE Servicewagen aus Holz. Struktur aus Birkenspertholz - Regale aus melaminharzbeschichtetem Birkenholz - Zierrahmen und Griff aus Struktur aus Birkenfurnierholz - Ablagefläche aus Furnierholz - umlaufender Rahmen aus Massivholz - erhältlich in den Farben Nussbaum und Wenge - Mehrweg-Chromräder ø 95 mm.

	ABX-CL2001 noce-walnut	ABX-CL2001W wengé
		
	106 x 55 x 85(h) cm	
	2	
	80 Kg	
	790 €	

ABX-CL2150

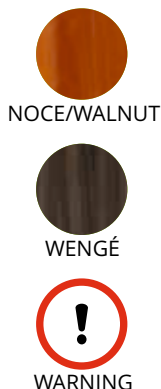

ABX-CL2151

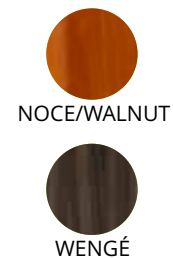

IT Carrelli di servizio in legno. Struttura in legno multistrato di betulla - ripiani in nobilitato - cornice perimetrale e maniglia in legno massello - disponibili nei colori noce e wengé - ruote multidirezionali di serie cromate ø 95 mm.

EN Wooden service trolleys. Birch multi-layered wood structure - melamine shelves - solid wood perimeter frame and handle - available in walnut and wenge colour - standard multidirectional chrome-plated wheels ø 95 mm.

FR Chariots de service en bois. Structure en bouleau multicouche - étagères en bois mélaminé - cadre périmétral et poignée en bois massif - disponible en noyer et wengé - de série roues multidirectionnelles chromées ø 95 mm.

DE Servicewagen aus Holz. Struktur aus Birkensperrholz - Regale aus melaminharzbeschichtetem Birkenholz - Zierrahmen und Griff aus Struktur aus Birkenfurnierholz - Ablagefläche aus Furnierholz - umlaufender Rahmen und Griff aus Massivholz - erhältlich in den Farben Nussbaum und Wenge - serienmäßig mit Mehrweg-Chromräder ø 95 mm.

IT Carrelli di servizio in legno. Struttura in legno multistrato di betulla - ripiani in nobilitato - cornice perimetrale e maniglia in legno massello - disponibili nei colori noce e wengé - ruote multidirezionali di serie cromate ø 95 mm.

EN Wooden service trolleys. Birch multi-layered wood structure - melamine shelves - solid wood perimeter frame and handle - available in walnut and wenge colour - standard multidirectional chrome-plated wheels ø 95 mm.

FR Chariots de service en bois. Structure en bouleau multicouche - étagères en bois mélaminé - cadre périmétral et poignée en bois massif - disponible en noyer et wengé - de série roues multidirectionnelles chromées ø 95 mm.

DE Servicewagen aus Holz. Struktur aus Birkensperrholz - Regale aus melaminharzbeschichtetem Birkenholz - Zierrahmen und Griff aus Struktur aus Birkenfurnierholz - Ablagefläche aus Furnierholz - umlaufender Rahmen und Griff aus Massivholz - erhältlich in den Farben Nussbaum und Wenge - serienmäßig mit Mehrweg-Chromräder ø 95 mm.

	ABX-CL2150 noce-walnut	ABX-CL2150W wengé
	86 x 55 x 85(h) cm	
	3	
	80 Kg	
	875 €	

	ABX-CL2151 noce-walnut	ABX-CL2151W wengé
	106 x 55 x 85(h) cm	
	3	
	80 Kg	
	920 €	

ABX-LP800

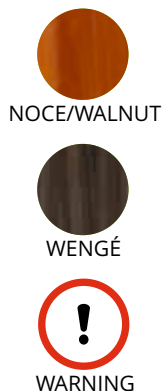

ABX-LP850

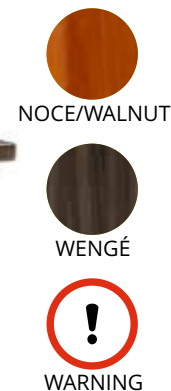

- IT** Carrelli di servizio in legno. Struttura in legno massello - ripiani in nobilitato di betulla - carrelli disponibili nei colori noce o wengé - ruote multidirezionali cromate ø 100 mm.
- EN** Wooden service trolleys. Solid wood structure - birch multi-layered wood shelves - trolleys available in walnut or wenge colour - multidirectional chrome-plated wheels ø 100 mm.
- FR** Chariots de service en bois. Structure en bois massif - étagères en bouleau mélaminé - chariot disponible en noyer ou wengé - roues multidirectionnelles chromées ø 100 mm.
- DE** Servicewagen aus Holz. Struktur aus melaminharzbeschichtetem Birkenholz - Regale aus melaminharzbeschichtetem Birkenholz - Zierrahmen und Griff aus Struktur aus Massivholz- Ablagefläche aus Birkenfurnierholz - erhältlich in den Farben Nussbaum oder Wenge - Mehrweg-Chromräder ø 100 mm.

- IT** Carrelli di servizio in legno. Struttura in legno massello - ripiani in nobilitato di betulla - carrelli disponibili nei colori noce o wengé - ruote multidirezionali cromate ø 100 mm.
- EN** Wooden service trolleys. Solid wood structure - birch multi-layered wood shelves - trolleys available in walnut or wenge colour - multidirectional chrome-plated wheels ø 100 mm.
- FR** Chariots de service en bois. Structure en bois massif - étagères en bouleau mélaminé - chariot disponible en noyer ou wengé - roues multidirectionnelles chromées ø 100 mm.
- DE** Servicewagen aus Holz. Struktur aus melaminharzbeschichtetem Birkenholz - Regale aus melaminharzbeschichtetem Birkenholz - Zierrahmen und Griff aus Struktur aus Massivholz- Ablagefläche aus Birkenfurnierholz - erhältlich in den Farben Nussbaum oder Wenge - Mehrweg-Chromräder ø 100 mm.

	ABX-LP800 noce-walnut	ABX-LP800W wengé
	81 x 55 x 82(h) cm	
	2	
	80 Kg	
	930 €	

	ABX-LP850 noce-walnut	ABX-LP850W wengé
	81 x 55 x 82(h) cm	
	3	
	80 Kg	
	1.120 €	



ABX-LP1000

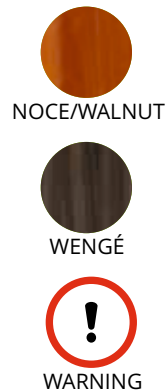

NOCE/WALNUT

WENGÉ

WARNING

ABX-LP1050

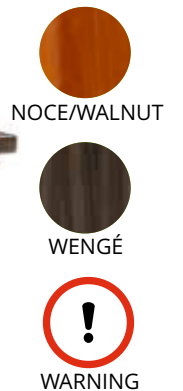

NOCE/WALNUT

WENGÉ

WARNING

IT Carrelli di servizio in legno. Struttura in legno massello - ripiani in nobilitato di betulla - carrelli disponibili nei colori noce o wengé - ruote multidirezionali cromate ø 100 mm.

IT Carrelli di servizio in legno. Struttura in legno massello - ripiani in nobilitato di betulla - carrelli disponibili nei colori noce o wengé - ruote multidirezionali cromate ø 100 mm.

EN Wooden service trolleys. Solid wood structure - birch multi-layered wood shelves - trolleys available in walnut or wenge colour - multidirectional chrome-plated wheels ø 100 mm.

EN Wooden service trolleys. Solid wood structure - birch multi-layered wood shelves - trolleys available in walnut or wenge colour - multidirectional chrome-plated wheels ø 100 mm.

FR Chariots de service en bois. Structure en bois massif - étagères en bouleau mélaminé - chariot disponible en noyer ou wengé - roues multidirectionnelles chromées ø 100 mm.

FR Chariots de service en bois. Structure en bois massif - étagères en bouleau mélaminé - chariot disponible en noyer ou wengé - roues multidirectionnelles chromées ø 100 mm.

DE Servicewagen aus Holz. Struktur aus melaminharzbeschichtetem Birkenholz - Regale aus melaminharzbeschichtetem Birkenholz - Zierrahmen und Griff aus Struktur aus Massivholz- Ablagefläche aus Birkenfurnierholz - erhältlich in den Farben Nussbaum oder Wenge - Mehrweg-Chromräder ø 100 mm.

DE Servicewagen aus Holz. Struktur aus melaminharzbeschichtetem Birkenholz - Regale aus melaminharzbeschichtetem Birkenholz - Zierrahmen und Griff aus Struktur aus Massivholz- Ablagefläche aus Birkenfurnierholz - erhältlich in den Farben Nussbaum oder Wenge - Mehrweg-Chromräder ø 100 mm.

	ABX-LP1000 noce-walnut	ABX-LP1000W wengé
	115 x 55 x 82(h) cm	
	2	
	80 Kg	
	975 €	

	ABX-LP1050 noce-walnut	ABX-1050W wengé
	115 x 55 x 82(h) cm	
	3	
	80 Kg	
	1.160 €	



ABX-CLC2012

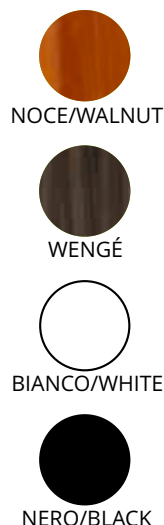

ABX-CLC2013



IT Carrelli di servizio in legno con cupola. Struttura in legno massello - ripiani in multistrato di betulla - cupola semicircolare in plexiglass apribile su due lati - maniglie di spinta integrate nel piano superiore - ringhiere di contenimento sui piani inferiori- carrelli disponibili nei colori noce, wengè, bianco e nero - ruote multidirezionali di serie cromate ø 95 mm.

EN Wooden service trolleys with dome. Solid wood structure - birch multi-layered wood shelves - half-circle dome in Plexiglas that opens on two sides - integrated push handles in the upper shelf - retaining rails on the lower shelves - trolleys available in walnut, wengè, white and black colour - standard multidirectional chrome-plated wheels ø 95 mm.

FR Chariots de service en bois avec clochette. Structure en bois massif - étagères en bouleau multicouche - clochette en plexiglas de forme semi-circulaire avec ouverture sur les deux côtés - poignées de poussée intégrées à l'étagère supérieure - profilés de retenue aux étagères inférieures - chariots disponibles en noyer, wengè, blanc et noir - de série roues multidirectionnelles chromées ø 95 mm.

DE Servicewagen aus Holz für Kuchen. Massivholzstruktur - Ablageflächen aus Birkenperrholz - zweiseitig aufklappbare, halbrunde Plexiglashaube - Schubgriffe eingebaut an der obersten Fläche - Halterungen in den untersten Etagen - Wagen in Nussbaum, Wenge, Weiß und Schwarz erhältlich - Mehrweg-Chromräder ø 95 mm.

IT Carrelli di servizio in legno con cupola. Struttura in legno massello - ripiani in multistrato di betulla - cupola semicircolare in plexiglass apribile su due lati - maniglie di spinta integrate nel piano superiore - ringhiere di contenimento sui piani inferiori- carrelli disponibili nei colori noce, wengè, bianco e nero - ruote multidirezionali di serie cromate ø 95 mm.

EN Wooden service trolleys with dome. Solid wood structure - birch multi-layered wood shelves - half-circle dome in Plexiglas that opens on two sides - integrated push handles in the upper shelf - retaining rails on the lower shelves - trolleys available in walnut, wengè, white and black colour - standard multidirectional chrome-plated wheels ø 95 mm.

FR Chariots de service en bois avec clochette. Structure en bois massif - étagères en bouleau multicouche - clochette en plexiglas de forme semi-circulaire avec ouverture sur les deux côtés - poignées de poussée intégrées à l'étagère supérieure - profilés de retenue aux étagères inférieures - chariots disponibles en noyer, wengè, blanc et noir - de série roues multidirectionnelles chromées ø 95 mm.

DE Servicewagen aus Holz für Kuchen. Massivholzstruktur - Ablageflächen aus Birkenperrholz - zweiseitig aufklappbare, halbrunde Plexiglashaube - Schubgriffe eingebaut an der obersten Fläche - Halterungen in den untersten Etagen - Wagen in Nussbaum, Wenge, Weiß und Schwarz erhältlich - Mehrweg-Chromräder ø 95 mm.

	ABX-CLC2012 noce-walnut	ABX-CLC2012W wengé	ABX-CLC2012B bianco-white	ABX-CLC2012N nero-black
	110 x 55 x 107(h) cm			
	2			
	80 Kg			
	1.010 €		1.162 €	

	ABX-CLC2013 noce-walnut	ABX-CLC2013W wengé	ABX-CLC2013B bianco-white	ABX-CLC2013N nero-black
	110 x 55 x 114(h) cm			
	3			
	80 Kg			
	1.230 €		1.460 €	

ABX-CL2260 ABX-CL2255



h 58 cm

NOCE/WALNUT

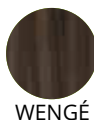

WENGÉ



WARNING

ABX-CL2350 ABX-CL2351



h 58 cm

NOCE/WALNUT

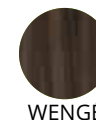

WENGÉ



WARNING

IT Carrelli di servizio in legno con cupola. Struttura portante in legno multistrato di betulla - cupola semicircolare in plexiglass apribile su due lati - maniglia di spinta in legno - disponibile nei colori noce e wengé - 2 ripiani - ruote multidirezionali \varnothing 100 mm. Il carrello in foto è con optional pianetto reggiplatto a scomparsa e cassetto portaposate a 3 scomparti .

EN Wooden service trolleys with dome. Load-bearing structure in birch multi-layered wood - half-circle dome in Plexiglas that opens on two sides - wooden push handle - available in walnut and wenge - 2 shelves - multidirectional wheels \varnothing 100 mm. The trolley shown here is equipped with optional retractable plate support and cutlery drawer with 3 compartments.

FR Chariots de service en bois avec clochette. Structure portante en bouleau multicouche - clochette en plexiglas de forme semi-circulaire avec ouverture sur les deux côtés - poignée en bois - disponible en noyer et wengé - 2 étagères - roues multidirectionnelles \varnothing 100 mm. Le chariot illustré est équipé en option d'un support pour assiettes rétractable et d'un tiroir à couverts à 3 compartiments.

DE Servicewagen aus Holz für Kuchen. Struktur aus Birkensperrholz Birkenholz - zweiseitig aufklappbare, halbrunde Plexiglashaube - Schubgriff aus Holz - erhältlich in Nussbaum und Wenge - 2 Einlegeböden - Mehrwegräder \varnothing 100 mm. Der Wagen auf dem Bild ist mit dem ausziehbarem Pfannenträger und Besteckschublade mit 3 Fächern ausgestattet.

IT Carrelli di servizio in legno con cupola. Struttura e ripiani in legno nobilitato - cupola semicircolare in plexiglass - maniglia di spinta in legno - disponibile nei colori noce e wengé - ruote multidirezionali 100 mm. Il carrello in foto è con optional pianetto reggiplatto a scomparsa e cassetto portaposate a 3 scomparti.

EN Wooden service trolleys with dome. Load-bearing structure in birch multi-layered wood - half-circle dome in Plexiglas - wooden push handle - available in walnut and wenge - multidirectional wheels \varnothing 100 mm. The trolley shown here is equipped with retractable plate support and cutlery drawer with 3 compartments.

FR Chariots de service en bois avec clochette. Structure portante en bouleau multicouche - clochette en plexiglas de forme semi-circulaire - poignée en bois - disponible en noyer et wengé - roues multidirectionnelles \varnothing 100 mm. Le chariot illustré est équipé en option d'un support pour assiettes rétractable et d'un tiroir à couverts à 3 compartiments.

DE Servicewagen aus Holz für Kuchen. Struktur aus Birkensperrholz und Ablageflächen aus melaminharzbeschichtetem Birkenholz - halbrunde Plexiglashaube - Schubgriff aus Holz - erhältlich in Nussbaum und Wenge - Mehrwegräder \varnothing 100 mm. Der Wagen auf dem Bild ist mit dem ausziehbarem Pfannenträger und Besteckschublade mit 3 Fächern ausgestattet.

	ABX-CL2255 noce-walnut	ABX-CL2255W wengé	ABX-CL2260 noce-walnut	ABX-CL2260W wengé
	86 x 55 x 110(h) cm		106 x 55 x 110(h) cm	
	2			
	80 Kg			
	1.000 €		1.055 €	

	ABX-CL2350 noce-walnut	ABX-CL2350W wengé	ABX-CL2351 noce-walnut	ABX-CL2351W wengé
	86 x 55 x 95(h) cm		106 x 55 x 95(h) cm	
	2			
	80 Kg			
	990 €		1.050 €	



ABX-LPC800 ABX-LPC850

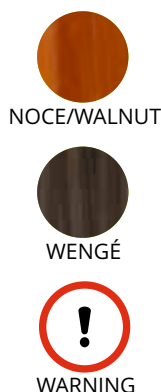

ABX-LPC1000 ABX-LPC1050



IT Carrelli di servizio in legno con cupola. Struttura portante in legno massello - ripiani in nobilitato di betulla - cupola semicircolare in plexiglass - ripiani in nobilitato - cornice perimetrale in legno massello - disponibile in colori noce o wengè - modelli a 2 o 3 ripiani - ruote multidirezionali \varnothing 100 mm.

EN Wooden service trolleys with dome. Load-bearing structure in solid wood - shelves in birch laminated wood - half-circle dome in Plexiglas - melamine shelves - solid wood perimeter frame - available in walnut or wengè colour - models with 2 or 3 shelves - multidirectional wheels \varnothing 100 mm.

FR Chariots de service en bois avec clochette. Structure portante en bois massif - étagères en bouleau mélaminé - clochette en plexiglas de forme semi-circulaire - étagères en bouleau stratifié - cadre périmétral en bois massif - disponible en noyer ou wengè - modèles à 2 ou 3 étagères - roues multidirectionnelles \varnothing 100 mm.



DE Servicewagen aus Holz für Kuchen. Struktur aus Massivholz - Ablageflächen aus melaminharzbeschichtetem Birkenholz - halbrunde Plexiglashaube - Ablageflächen aus Melamin - umlaufender Rahmen aus Massivholz - erhältlich in den Farben Nussbaum oder Wenge - Modelle mit 2 oder 3 Einlegeböden - Mehrwegräder \varnothing 100 mm.





IT Carrelli di servizio in legno con cupola. Struttura portante in legno massello - ripiani in nobilitato di betulla - cupola semicircolare in plexiglass - ripiani in nobilitato - cornice perimetrale in legno massello - disponibile in colori noce o wengè - modelli a 2 o 3 ripiani - ruote multidirezionali \varnothing 100 mm.

EN Wooden service trolleys with dome. Load-bearing structure in solid wood - shelves in birch laminated wood - half-circle dome in Plexiglas - melamine shelves - solid wood perimeter frame - available in walnut or wengè colour - models with 2 or 3 shelves - multidirectional wheels \varnothing 100 mm.

FR Chariots de service en bois avec clochette. Structure portante en bois massif - étagères en bouleau mélaminé - clochette en plexiglas de forme semi-circulaire - étagères en bouleau stratifié - cadre périmétral en bois massif - disponible en noyer ou wengè - modèles à 2 ou 3 étagères - roues multidirectionnelles \varnothing 100 mm.

DE Servicewagen aus Holz für Kuchen. Struktur aus Massivholz - Ablageflächen aus melaminharzbeschichtetem Birkenholz - halbrunde Plexiglashaube - Ablageflächen aus Melamin - umlaufender Rahmen aus Massivholz - erhältlich in den Farben Nussbaum oder Wenge - Modelle mit 2 oder 3 Einlegeböden - Mehrwegräder \varnothing 100 mm.

	ABX-LPC800 noce-walnut	ABX-LPC800W wengé	ABX-LPC850 noce-walnut	ABX-LPC850W wengé
	81 x 55 x 108(h) cm			
	2		3	
	80 Kg			
	1.170 €		1.370 €	

	ABX-LPC1000 noce-walnut	ABX-LPC1000W wengé	ABX-LPC1050 noce-walnut	ABX-LPC1050W wengé
	115 x 55 x 108(h) cm			
	2		3	
	80 Kg			
	1.275 €		1.410 €	



ABX-CL2785

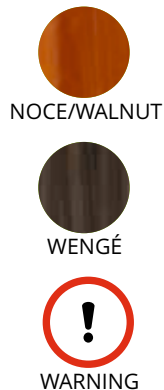

- IT** Carrello di servizio in legno con cupola. Struttura portante in legno multistrato di betulla - cupola in plexiglass trasparente 150(h) mm - vasca e griglia in acciaio inox - 8 piastre eutettiche refrigeranti - ruote multidirezionali Ø 100 mm. Può contenere numero 5 bacinelle GN1/4 con 65(h) mm oppure 5 bacinelle GN1/6 con 65(h) mm.
- EN** Wooden service trolley with dome. Multi-layered birch wood supporting structure - clear Plexiglas dome 150(h) mm - stainless steel bowl and grid - 8 refrigerant eutectic plates - multidirectional wheels Ø 100 mm. It can contain 5 GN1/4 containers 65(h) mm or 5 GN1/6 containers 65(h) mm.
- FR** Chariot de service en bois avec clochette. Structure portante en bouleau multicouche - clochette en plexiglas transparent 150(h) mm - cuve et grille en acier inox - 8 plaques de refroidissement eutectiques - roues multidirectionnelles Ø 100 mm. Contient 5 bacs GN1/4 avec 65(h) mm ou 5 bacs GN1/6 avec 65(h) mm.
- DE** Servicewagen aus Holz für Kuchen. Tragkonstruktion aus Birkensperrholz - transparente Plexiglashaube 150(h) mm - Edelstahlbehälter und Grill - 8 Eutektik-Kühlplatten - Mehrwegräder Ø 100 mm. Enthält 5 GN1/4 Behälter mit 65(h) mm oder 5 GN1/6 Behälter mit 65(h) mm.

	ABX-CL2785 noce-walnut	ABX-CL2785W wengé
	106 x 55 x 108(h) cm	
	2	
	1.960 €	

Carrelli di servizio in legno con cupola

WOODEN SERVICE TROLLEYS WITH DOME
CHARIOTS DE SERVICE EN BOIS AVEC CLOCHETTE
SERVICEWAGEN AUS HOLZ MIT HAUBE

ABX-A100

Pianetto reggipiatto a scomparsa
Retractable shelf
Étagère à plateaux encastrée
Verdeckte Tablettablage

77 €

ABX-A200

Cassetto portaposate a 3 scomparti
Cutlery drawer with 3 compartments
Tiroir à couverts avec 3 compartiments
Besteckschublade mit 3 Fächern

110 €



Carrelli di servizio in legno con cupola
Wooden service trolleys with dome



ABX-CL2751 ABX-CL2752



h 35 cm

-  NOCE/WALNUT
-  WENGÉ
-  WARNING





- IT** Carrelli Flambé. Struttura portante in legno multistrato di betulla monocorpo - rivestimento in legno massello di castagno - piano di cottura in acciaio inox - ribaltina laterale - maniglia di spinta in acciaio cromato - portabottiglie in acciaio cromato - 2 cassetti - vano porta bombola da 2 kg - ruote multidirezionali \varnothing 100 mm.
- EN** Flambé trolleys. Load-bearing structure in one-piece multi-layered wood - solid chestnut wood lining - stainless steel cooking plate - side folding panel - chrome-plated steel push handle - chrome-plated steel bottle rack - 2 drawers - 2 kg gas bottle compartment - multidirectional wheels \varnothing 100 mm.
- FR** Chariots Flambé. Structure portante en bois de bouleau multicouche à structure monocoque - revêtement en châtaignier massif - plaque de cuisson en acier inox - volet latéral - poignée de poussée en acier chromé - porte-bouteille en acier chromé - 2 tiroirs - compartiment porte- bouteille de 2 kg - roues multidirectionnelles \varnothing 100 mm.
- DE** Flambé-Wagen. Monoblock Struktur aus Birkensperrholz - Verkleidung aus massivem Kastanienholz - Kochplatte aus Edelstahl - Seitenklappe - Schubgriff aus verchromtem Stahl - Flaschenständer aus verchromtem Stahl - 2 Schubladen - 2 kg Gasflaschenfach - Mehrwegräder \varnothing 100 mm.

ABX-CL2750



h 35 cm

Carrelli Flambé
Flambé trolleys

	ABX-CL2751 noce-walnut	ABX-CL2751W wengé	ABX-CL2752 noce-walnut	ABX-CL2752W wengé
	107/145 x 58 x 91(h) cm			
	1 piastra - 1 fuoco 1 plate - 1 burner		2 piastre a 1 fuoco separato 2 plates 1 separate burner	
	35 Kg		35 Kg	
	1.710 €		2.020 €	





	ABX-CL2750 noce-walnut	ABX-CL2750W wengé
	107/145 x 58 x 91(h) cm	
	1 piastra - 2 fuochi 1 plate - 2 burners	
	35 Kg	
	1.840 €	



Foto con OPTIONAL - n. 4 ruote con cuffia ottonata o cromata
Photos with OPTIONAL - 4 Brass or chrome ball casters
Photo avec ACCESSOIRES -4 Roulette à bille en laiton ou chromée
Abgebildet mit ZUBEHÖR - 4 Messing- oder Chrom-Kugelrolle

ABX-CF1200
ABX-CF1201
ABX-CF1202



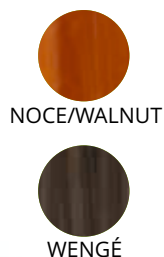

↑
h 35 cm
↓

- IT** Carrelli Flambè. Struttura portante in legno nobilitato - piano di cottura in acciaio inox con bruciatore regolabile - ribaltina laterale - maniglia di spinta in acciaio cromato - portabottiglie in acciaio cromato - 1 cassetto - 1 sportello vano porta bombola da 3 Kg - ruote multidirezionali ø 100 mm.
- EN** Flambé trolleys. Load-bearing structure in laminated wood - stainless steel cooking plate with adjustable burner - side folding panel - chrome-plated steel push handle - chrome-plated steel bottle rack - 1 drawer - 3 kg gas bottle compartment - multidirectional wheels ø 100 mm.
- FR** Chariots Flambé. Structure portante en bois mélaminé - plaque de cuisson en acier inox avec brûleur réglable - volet latéral - poignée de poussée en acier chromé - porte-bouteille en acier chromé - 1 tiroir - compartiment avec porte pour bouteille de 3 kg - roues multidirectionnelles ø 100 mm.
- DE** Flambè-Wagen. Struktur aus melaminharzbeschichtetem Holz - Kochplatte aus Edelstahl mit einstellbarem Brenner - Schubgriff aus verchromtem Stahl - Flaschenständeraus verchromtem Stahl - 1 Schublade - 3 Kg Gasflaschenfach - Mehrwegräder ø 100 mm.

Carrelli Flambé
Flambè Trolleys

ABX-AB2 CL2750-51-52	ABX-AB3 CF1200-1201-1202
Bombola gas 2 Kg. (vuota) Gas bottle 2 kg (empty) Bouteille de gaz 2 kg (vide) Gasflasche 2 kg (leer)	Bombola gas 3 Kg. (vuota) Gas bottle 3 kg (empty) Bouteille de gaz 3 kg (vide) Gasflasche 3 kg (leer)
	
80 €	85 €

i	ABX-CF1200 noce-walnut	ABX-CF1200W wengé	ABX-CF1201 noce-walnut	ABX-CF1201W wengé
	105/137 x 57 x 91(h) cm			
	1 piastra - 1 fuoco 1 plate - 1 burner		1 piastra - 2 fuochi 1 plate - 2 burners	
	35 Kg			
	1.245 €		1.375 €	

i	ABX-CF1202 noce-walnut	ABX-CF1202W wengé
	105/137 x 57 x 91(h) cm	
	2 piastre a 1 fuoco separato 2 plates 1 separate burner	
	35 Kg	
	1.570 €	

ABX-ML3000SS

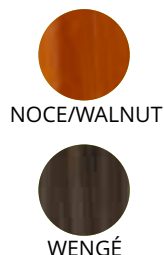

ABX-ML3170SS ABX-ML3170ST



IT Mobili di servizio bassi doppi - struttura e pannelli in nobilitato con bordi protetti da profilo in gomma - 2 cassetti portaposate di cui 1 con separatore - 2 sportelli - disponibile in colore noce e wengé - ruote multidirezionali \varnothing 50 mm.

EN Low double service cabinets - structure and panels in melamine with edges protected by rubber profile - 2 cutlery drawers, 1 with separator - 2 doors - available in walnut and wenge colour - multidirectional wheels \varnothing 50 mm.

FR Meubles bas de service double - structure et panneaux en mélaminé avec bords en caoutchouc - 2 tiroirs à couverts dont 1 avec séparateur - 2 portes - disponible en noyer et wengé - roues multidirectionnelles \varnothing 50 mm.

DE Niedrige Doppelservicemöbel - Struktur und Blenden aus Melamin mit Gummikantenschutz - 2 Besteckschubladen, davon 1 mit Trennwand - 2 Türen - erhältlich in Nussbaum und Wenge - Mehrwegräder \varnothing 50 mm.



IT Mobili di servizio alti doppi - struttura e pannelli in nobilitato con bordi protetti da profilo in gomma - sportello superiore in plexiglass fumè - 2 cassetti portaposate di cui 1 con separatore - 2 sportelli (SS) oppure 1 sportello e 1 tramoggia (ST) - disponibile in colore noce - ruote multidirezionali \varnothing 50 mm.

EN High double service cabinets - structure and panels in melamine with edges protected by a rubber profile - smoky grey Plexiglas upper door - 2 cutlery drawers, 1 with separator - 2 doors (SS) or 1 door and 1 hopper (ST) - available in walnut colour - multidirectional wheels \varnothing 50 mm.

FR Meubles hauts de service double - structure et panneaux en mélaminé avec bords en caoutchouc - porte supérieure en plexiglas fumé - 2 tiroirs à couverts dont 1 avec séparateur - 2 portes (SS) ou 1 porte et 1 trémie (ST) - disponible en noyer - roues multidirectionnelles \varnothing 50 mm.

DE Hohe Doppelservicemöbel - Struktur und Blenden aus Melamin mit Gummikantenschutz - obere Tür aus dunklem Plexiglas - 2 Besteckschubladen, davon 1 mit Trennwand - 2 Türen (SS) oder 1 Tür und 1 Trichter (ST) - erhältlich in Nussbaum - Mehrwegräder \varnothing 50 mm.

	ABX-ML3000SS noce-walnut	ABX-ML3000SSW wengé
	95 x 49 x 99(h) cm	
	2 sportelli - 2 cassetti 2 doors - 2 drawers	
	830 €	

	ABX-ML3170SS noce-walnut	ABX-ML3170ST noce-walnut
	95 x 49 x 144(h) cm	
	2 sportelli in plexiglas fumè 2 sportelli - 2 cassetti 2 doors in smoky grey Plexiglas 2 doors - 2 drawers	2 sportelli in plexiglas fumè 1 sportello - 1 tramoggia - 2 cassetti 2 doors in smoky grey Plexiglas 1 door - 1 hopper - 2 drawers
	1.310 €	1.425 €

ABX-ML3150ST ABX-ML3100SS



NOCE/WALNUT



WENGÉ



ABX-ML3050S



NOCE/WALNUT



IT Mobili di servizio alti doppi - struttura e pannelli in nobilitato con bordi protetti da profilo in gomma - alzatina con 2 mensole - 2 cassetti portaposate di cui 1 con separatore - 2 sportelli (SS) oppure 1 sportello e 1 tramoggia (ST) - disponibile in colore noce e wengé - ruote multidirezionali ø 50 mm.

EN High double service cabinets - structure and panels in melamine with edges protected by rubber profile - backsplash with 2 shelves - 2 cutlery drawers, 1 with separator - 2 doors (SS) or 1 door and 1 hopper (ST) - available in walnut and wenge colour - multidirectional wheels ø 50 mm.

FR Meubles hauts de service double - structure et panneaux en mélaminé avec bords en caoutchouc - dossier avec 2 étagères - 2 tiroirs à couverts dont 1 avec séparateur - 2 portes (SS) ou 1 porte et 1 trémie (ST) - disponible en noyer et wengé - roues multidirectionnelles ø 50 mm.

DE Hohe Doppelservicemöbel - Struktur und Blenden aus Melamin mit Gummikantenschutz - Rückwand mit 2 Regalen - 2 Besteckschubladen, davon 1 mit Trennwand - 2 Türen (SS) oder 1 Tür und 1 Trichter (ST) - erhältlich in Nussbaum und Wenge - Mehrwegräder ø 50 mm.

IT Mobile di servizio alto singolo - struttura e pannelli in nobilitato con bordi protetti da profilo in gomma - alzatina con 2 mensole - 1 cassetto portaposate con separatore - 1 sportello - disponibile in colore noce - ruote multidirezionali ø 50 mm.

EN Low single service cabinet - structure and panels in melamine with edges protected by rubber profile - backsplash with 2 shelves - 1 cutlery drawer with separator - 1 door - available in walnut colour - multidirectional wheels ø 50 mm.

FR Meuble bas de service simple - structure et panneaux en mélaminé avec bords en caoutchouc - dossier avec 2 étagères - 1 tiroir à couverts avec séparateur - 1 porte - disponible en noyer et wengé - roues multidirectionnelles ø 50 mm.

DE Niedrige Doppelservicemöbel - Struktur und Blenden aus Melamin mit Gummikantenschutz - Rückwand mit 2 Regalen - 1 Besteckschublade mit Trennwand - 1 Tür - erhältlich in Nussbaumfarbe - Mehrwegräder ø 50 mm.

	ABX-ML3150ST noce-walnut	ABX-ML3150STW wengé	ABX-ML3100SS noce-walnut	ABX-ML3100SSW wengé
	95 x 49 x 144(h) cm			
	1 sportello - 1 tramoggia - 2 cassetti 1 door - 1 hopper - 2 drawers		2 sportelli - 2 cassetti 2 doors - 2 drawers	
	1.150 €		1.030 €	

	ABX-ML3050S noce-walnut
	45 x 49 x 144(h) cm
	1 sportello - 1 cassetto 1 door - 1 drawer
	910 €

ABX-ML3202SS



ABX-ML3212SS



IT Mobili di servizio in legno. Mobili di servizio bassi doppi - struttura e pannelli in nobilitato - 2 cassetti portaposate di cui 1 con separatore - 2 sportelli - disponibile in colore noce, wengé e rovere - ruote multidirezionali ø 50 mm.

EN Wooden service cabinets. Low double service cabinets - melamine structure and panels - 2 cutlery drawers, 1 with separator - 2 doors - available in walnut, wenge and oak colour - multidirectional wheels ø 50 mm.

FR Meubles de service en bois. Meubles bas de service double - structure et panneaux en mélaminé - 2 tiroirs à couverts dont 1 avec séparateur - 2 portes - disponible en noyer, wengé et chêne - roues multidirectionnelles ø 50 mm.

DE Servicemöbel aus Holz. Niedrige Doppelservicemöbel - Struktur und Blenden aus Melamin - 2 Besteckschubladen, davon 1 mit Trennwand - 2 Türen - erhältlich in Nussbaum, Wenge und Eichenfarbe - Mehrwegräder ø 50 mm.

IT Mobili di servizio alti doppi - struttura e pannelli in nobilitato - 2 cassetti portaposate di cui 1 con separatore - 2 sportelli - disponibile in colore noce, wengé e rovere - ruote multidirezionali ø 50 mm.

EN High double service cabinets - melamine structure and panels - 2 cutlery drawers, 1 with separator - 2 doors - available in walnut, wenge and oak colour - multidirectional wheels ø 50 mm.

FR Meubles hautes de service double - structure et panneaux en mélaminé - 2 tiroirs à couverts dont 1 avec séparateur - 2 portes - disponible en noyer, wengé et chêne - roues multidirectionnelles ø 50 mm.

DE Hohe Doppelservicemöbel - Struktur und Blenden aus Melamin - 2 Besteckschubladen, davon 1 mit Trennwand - 2 Türen - erhältlich in Nussbaum, Wenge und Eichenfarbe - Mehrwegräder ø 50 mm.

	ABX-ML3202SSN noce-walnut	ABX-ML3202SSW wengé	ABX-ML3202SS rovere-durmast
	90 x 48 x 95(h) cm		
	2 sportelli - 2 cassetti 2 doors - 2 drawers		
	870 €		

	ABX-ML3212SSN noce-walnut	ABX-ML3212SSW wengé	ABX-ML3212SS rovere-durmast
	90 x 48 x 155(h) cm		
	2 sportelli - 2 cassetti 2 doors - 2 drawers		
	1.230 €		

ABX-ML3200S



NOCE/WALNUT



WENGÉ



ROVERE/
DURMAST



ABX-ML3210S



NOCE/WALNUT



WENGÉ



ROVERE/
DURMAST



IT Mobili di servizio singoli bassi - struttura e pannelli in nobilitato - 1 cassetto portaposate con separatore - 1 sportello - disponibile in colore noce, wengé e rovere - ruote multidirezionali ø 50 mm.

EN High single service cabinet - melamine structure and panels - 1 cutlery drawer with separator - 1 door - available in walnut, wenge and oak colour - multidirectional wheels ø 50 mm.

FR Meubles bas de service simple - structure et panneaux en mélaminé - 1 tiroir à couverts avec séparateur - 1 porte - disponible en noyer, wengé et chêne - roues multidirectionnelles ø 50 mm.

DE Niedrige Einzelne Servicemöbeln - Struktur und Blenden aus Melamin - 1 Besteckschublade mit Trennwand - 1 Tür - erhältlich in Nussbaum, Wenge und Eichenfarbe - Mehrwegräder ø 50 mm.

IT Mobili di servizio singoli alti - struttura e pannelli in nobilitato - 1 cassetto portaposate con separatore - 1 sportello - disponibile in colore noce, wengé e rovere - ruote multidirezionali ø 50 mm.

EN High single service cabinet - melamine structure and panels - 1 cutlery drawer with separator - 1 door - available in walnut, wenge and oak colour - multidirectional wheels ø 50 mm.

FR Meubles hautes de service simple - structure et panneaux en mélaminé - 1 tiroir à couverts avec séparateur - 1 porte - disponible en noyer, wengé et chêne - roues multidirectionnelles ø 50 mm.

DE Hohe Einzelne Servicemöbeln - Struktur und Blenden aus Melamin - 1 Besteckschublade 1 mit Trennwand - 1 Tür - erhältlich in Nussbaum, Wenge und Eichenfarbe - Mehrwegräder ø 50 mm.

	ABX-ML3200SN noce-walnut	ABX-ML3200SW wengé	ABX-ML3200S rovere-durmast
	45 x 48 x 95(h) cm		
	1 sportello - 1 cassetto 1 door - 1 drawer		
	640 €		

	ABX-ML3210SN noce-walnut	ABX-ML3210SW wengé	ABX-ML3210S rovere-durmast
	45 x 48 x 155(h) cm		
	1 sportello - 1 cassetto 1 door - 1 drawer		
	995 €		



ABX-ML3204SS



NOCE/WALNUT

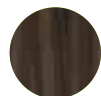

WENGÉ



ROVERE/
DURMAST



ABX-ML3214SS



NOCE/WALNUT



WENGÉ



ROVERE/
DURMAST



IT Mobili di servizio bassi tripli - struttura e pannelli in nobilitato - 3 cassetti portaposate di cui 2 con separatore - 2 sportelli - 1 vano interno - disponibile in colore noce, wengé e rovere - ruote multidirezionali ø 50 mm.

EN Low triple service cabinets - melamine structure and panels - 3 cutlery drawers, 2 with separator - 2 doors - 1 internal compartment - available in walnut, wenge and oak colour - multidirectional wheels ø 50 mm.

FR Meubles bas de service triple - structure et panneaux mélaminés - 3 tiroirs à couverts, dont 2 avec séparateur - 2 portes - 1 compartiment intérieur - disponible en couleur noyer, wengé et chêne - roues multidirectionnelles ø 50 mm.

DE Niedrige Trippelservicemöbel - Struktur und Blenden aus Melamin - 3 Besteckschubladen, davon 2 mit Trennwand - 2 Türen - 1 Innenfach - erhältlich in Nussbaum, Wenge und Eichenfarbe - Mehrwegräder ø 50 mm.

IT Mobili di servizio alti tripli - struttura e pannelli in nobilitato - 3 cassetti portaposate di cui 2 con separatore - 2 sportelli - 1 vano interno - disponibile in colore noce, wengé e rovere - ruote multidirezionali ø 50 mm.

EN High triple service cabinets - melamine structure and panels - 3 cutlery drawers, 3 with separator - 2 doors - 1 internal compartment - available in walnut, wenge and oak colour - multidirectional wheels ø 50 mm.

FR Meubles de service hautes triple - structure et panneaux en mélaminé - 3 tiroirs à couverts dont 2 avec séparateur - 2 portes - 1 compartiment intérieur - disponible en noyer, wengé et chêne - roues multidirectionnelles ø 50 mm.

DE Hohe Trippelservicemöbel - Struktur und Blenden aus Melamin - 3 Besteckschubladen, davon 2 mit Trennwand - 2 Türen - 1 Innenfach - erhältlich in Nussbaum, Wenge und Eichenfarbe - Mehrwegräder ø 50 mm.

	ABX-ML3204SSN noce-walnut	ABX-ML3204SSW wengé	ABX-ML3204SS rovere-durmast
	136 x 48 x 95(h) cm		
	2 sportelli - 3 cassetti - 1 vano interno 2 doors - 3 drawers - 1 internal compartment		
	1.130 €		

	ABX-ML3214SSN noce-walnut	ABX-ML3214SSW wengé	ABX-ML3214SS rovere-durmast
	136 x 48 x 155(h) cm		
	2 sportelli - 3 cassetti - 1 vano interno 2 doors - 3 drawers - 1 internal compartment		
	1.530 €		

ABX-ML3212SSP

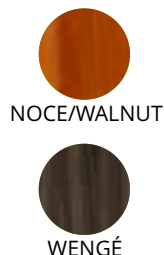

ABX-ML3214SSP

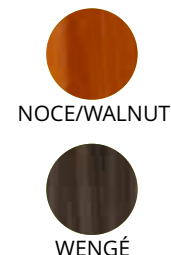

IT Mobili di servizio alti doppi - struttura e pannelli in nobilitato - struttura reggi pensili in acciaio plastificato - 2 pensili - 2 cassetti portaposate di cui 1 con separatore - 2 sportelli - disponibile in colore noce e wengé - ruote multidirezionali ø 50 mm. Optional tramoggia A270-A270W.

EN High double service cabinets - melamine structure and panels - plastic-coated steel wall cabinets support structure - 2 wall cabinets - 2 cutlery drawers, 1 with separator - 2 doors - available in walnut and wenge colour - multidirectional wheels ø 50 mm. Optional hopper A270-A270W.

FR Meubles hautes de service double - structure et panneaux en mélaminé - 2 tiroirs à couverts dont 1 avec séparateur - 2 portes - disponible en noyer, wengé et chêne - roues multidirectionnelles ø 50 mm. Trémie A270-A270W en option.



DE Hohe Servicemöbel - Struktur und Blenden aus Melamin - kunststoffbeschichtete Stahl-Halterungen - 2 Hängeschränke - 2 Besteckschubladen, davon 1 mit Trennwand - 2 Türen - erhältlich in Nussbaum und Wenge - Mehrwegräder ø 50 mm. Auf Wunsch Trichter A270-A270W.



IT Mobili di servizio alti tripli - struttura e pannelli in nobilitato - struttura reggi pensili in acciaio plastificato - 3 pensili - 3 cassetti portaposate di cui 2 con separatore - 2 sportelli - 1 vano interno - disponibile in colore noce e wengé - ruote multidirezionali ø 50 mm.

EN High triple service cabinets - melamine structure and panels - plastic-coated steel wall cabinets support structure - 3 wall cabinets - 3 cutlery drawers, 2 with separator - 2 doors - 1 internal compartment - available in walnut and wenge colour - multidirectional wheels ø 50 mm.

FR Meubles de service hautes triple - structure et panneaux en mélaminé - structure de supports pour meubles à mur en acier plastifié - 3 tiroirs à couverts dont 2 avec séparateur - 2 portes - 1 compartiment intérieur - disponible en noyer et wengé - roues multidirectionnelles ø 50 mm.

DE Hohe Trippelservicemöbel - Struktur und Blenden aus Melamin - kunststoffbeschichtete Stahl-Halterungen - 3 Hängeschränke - 3 Besteckschubladen, davon 2 mit Trennwand - 2 Türen - 1 Innenfach - erhältlich in Nussbaum und Wenge - Mehrwegräder ø 50 mm.

	ABX-ML3212SSPN noce-walnut	ABX-ML3212SSPW wengé
	92 x 48 x 153(h) cm	
	2 pensili - 2 sportelli - 2 cassetti 2 wall cabinets - 2 doors - 2 drawers	
	1.535 €	

	ABX-ML3214SSPN noce-walnut	ABX-ML3214SSPW wengé
	137 x 48 x 153(h) cm	
	3 pensili - 2 sportelli - 3 cassetti - 1 vano interno 3 wall cabinets - 2 doors - 3 drawers - 1 internal compartment	
	1.880 €	



Su tutti i modelli On all models

CL - CLP - CLC

n. 4 ruote con cuffia ottonata o cromata
4 brass or chrome plated copper castors
4roulette à bille en laiton ou chromée
4 Messing- oder Chrom-Kugelrolle



160 €

Solo per mobili di servizio Service furniture only

Applicazione tramoggia per mobili
overprice for furniture hopper
surprix de trémie pour meubles
Preiszuschlag für Möbeltrichter

ABX-A250	ABX-A250W	ABX-A260	ABX-A270
ABX-ML3000SS		ABX-ML3200SS	
ABX-ML3170SS	ABX-ML3000SSW	ABX-ML3202SS	
ABX-ML3100SS	ABX-ML3100SSW	ABX-ML3210S	ABX-ML3214SSPN
ABX-ML3050S		ABX-ML3212SS	ABX-ML3214SSPW
		ABX-ML3204SS	
		ABX-ML3210SN	
		ABX-ML3212SSPN	

148 €

Carrelli di servizio in legno Wooden service trolleys

Espositore di vini - portabottiglie - struttura in legno
Wine display rack - bottle rack - wooden frame
Présentoir à vin - porte-bouteilles - structure en bois
Weinständer - Flaschenregal - Holzstruktur

	ABX-A1250 noce-walnut	ABX-A1250W wengé	ABX-A1260 noce-walnut	ABX-A1260W wengé
Mod.	ABX-CL2000 ABX-CL2150	ABX-CL2000W ABX-CL2150W	ABX-CL2001 ABX-CL2151	ABX-CL2001W ABX-CL2151W
↗ cm	68 x 46 x 19(h) cm		88 x 46 x 19(h) cm	
	290 €		370 €	



Espositore di liquori - portabottiglie - struttura in legno - ringhiere in acciaio inox
Wine display rack, bottle rack, wooden frame, stainless steel railings
Présentoir à vin, porte-bouteilles, structure en bois, barres de protection en acier inox
Weinständer - Flaschenregal - Holzstruktur, Edelstahlleisten

	ABX-A1270 noce-walnut	ABX-A1270W wengé	ABX-A1280 noce-walnut	ABX-A1280W wengé
Mod.	ABX-CL2000 ABX-CL2150	ABX-CL2000W ABX-CL2150W	ABX-CL2001 ABX-CL2151	ABX-CL2001W ABX-CL2151W
↗ cm	68 x 46 x 37(h) cm		88 x 46 x 37(h) cm	
	200 €		220 €	



Carrelli di servizio in legno Wooden service trolleys

Espositore ghiacciaia. Struttura in legno con vasca e griglia in acciaio inox - cupola plexiglass - provvisto di 8 contenitori eutectici.

Icebox display. Wooden structure with stainless steel bowl and grill - Plexiglas dome - equipped with 8 eutectic containers.

Présentoir glacière. Structure en bois avec cuve et grille en acier inox - clochette en plexiglas - équipé de 8 conteneurs eutectiques.

Gefrierfachavitrine. Holzstruktur mit Edelstahlwanne und Gitter - Plexiglashaube - ausgestattet mit 8 eutektischen Behältern.



	ABX-A1290 noce-walnut	ABX-A1290W wengé
Mod.	ABX-CL2001 ABX-CL2151	ABX-CL2001W ABX-CL2151W
 cm	90 x 48,5 x 23(h) cm	
	950 €	



Vetrinetta con struttura in legno e cupola in plexiglass

Display with wooden structure and Plexiglas dome.

Présentoir avec structure en bois et clochette en plexiglas.

Vitrine mit Holzstruktur und Plexiglashaube.



	ABX-A1299 noce-walnut	ABX-A1299W wengé	ABX-A1298 noce-walnut	ABX-A1298W wengé
Mod.	ABX-CL2000 ABX-CL2150	ABX-CL2000W ABX-CL2150W	ABX-CL2001 ABX-CL2151	ABX-CL2001W ABX-CL2151W
 cm	70 x 50 x 22(h) cm		90 x 50 x 22(h) cm	
	395 €		425 €	

Optional



Carrelli di servizio in acciaio inox



ABX-CA1000 ABX-CA1001

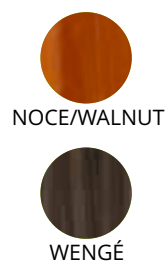

ABX-CA1050 ABX-CA1051



IT Struttura tubolare 20x20 mm in acciaio inox AISI 304 - ripiani in nobilitato con cornice perimetrale in acciaio inox AISI 304 - paracolpi in gomma - ruote multidirezionali \varnothing 125 mm.

EN Tubular structure 20x20 mm in stainless steel AISI 304 - melamine shelves with perimeter frame in stainless steel AISI 304 - rubber shock absorber - multidirectional wheels \varnothing 125 mm.

FR Structure tubulaire 20x20 mm en acier inox AISI 304 - étagères en mélaminé avec cadre périmétral en acier inox AISI 304 - butoirs en caoutchouc - roues multidirectionnelles \varnothing 125 mm.





DE Rohrrahmen 20x20 mm aus Edelstahl AISI 304 - Ablageflächen aus Melamin mit umlaufendem Rahmen aus Edelstahl AISI 304 - Gummistoßschutz - Mehrwegräder \varnothing 125 mm.





IT Struttura tubolare 20x20 mm in acciaio inox AISI 304 - ripiani in nobilitato con cornice perimetrale in acciaio inox AISI 304 - paracolpi in gomma - ruote multidirezionali \varnothing 125 mm.

EN Tubular structure 20x20 mm in stainless steel AISI 304 - shelves in melamine with perimeter frame in stainless steel AISI 304 - rubber shock absorber - multidirectional wheels \varnothing 125 mm.

FR Structure tubulaire 20x20 mm en acier inox AISI 304 - étagères en mélaminé avec cadre périmétral en acier inox AISI 304 - butoirs en caoutchouc - roues multidirectionnelles \varnothing 125 mm.

DE Rohrrahmen 20x20 mm aus Edelstahl AISI 304 - Ablageflächen aus Melamin mit umlaufendem Rahmen aus Edelstahl - AISI 304 Gummistoßschutz - Mehrwegräder \varnothing 125 mm.

	ABX-CA1000 noce-walnut	ABX-CA1000W wengé	ABX-CA1001 noce-walnut	ABX-CA1001W wengé
 cm	83 x 57 x 97(h) cm		103 x 57 x 97(h) cm	
 N.	2			
 mm	72,4 x 50 cm		92,4 x 50 cm	
 MAX Kg	60 Kg			
	360 €		380 €	

	ABX-CA1050 noce-walnut	ABX-CA1050W wengé	ABX-CA1051 noce-walnut	ABX-CA1051W wengé
 cm	83 x 57 x 97(h) cm		103 x 57 x 97(h) cm	
 N.	3			
 mm	72,4 x 50 cm		92,4 x 50 cm	
 MAX Kg	60 Kg			
	485 €		515 €	

Carrelli di servizio in acciaio inox e ripiani in nobilitato
Stainless steel service trolleys and melamine shelves

OPTIONAL



ABX-CA1070 ABX-CA1071



NOCE/WALNUT



- IT** Struttura tubolare 20x20 mm in acciaio inox AISI 304 - ripiani in nobilitato con cornice perimetrale in acciaio inox AISI 304 - paracolpi in gomma - ruote multidirezionali \varnothing 125 mm.
- EN** Tubular structure 20x20 mm in stainless steel AISI 304 - shelves in melamine with perimeter frame in stainless steel AISI 304 - rubber shock absorber - multidirectional wheels \varnothing 125 mm.
- FR** Structure tubulaire 20x20 mm en acier inox AISI 304 - étagères en mélaminé avec cadre périmétral en acier inox - butoirs en AISI 304 caoutchouc - roues multidirectionnelles \varnothing 125 mm.
- DE** Rohrrahmen 20x20 mm aus Edelstahl AISI 304 - Ablageflächen aus Melamin mit umlaufendem Rahmen aus Edelstahl AISI 304 Gummistoßschutz - Mehrwegräder \varnothing 125 mm.

	ABX-CA1070 noce-walnut	ABX-CA1071 noce-walnut
	83 x 57 x 172(h) cm	103 x 57 x 172(h) cm
	4	
	72,4 x 50 cm	92,4 x 50 cm
	60 Kg	
	640 €	670 €

Optional

ABX-A512

Ruote con freno - Wheels with catch
Roues avec frein - Räder mit Bremse

CA 1000-1050-1070-1071
CA 1380-81-82-83-84-85-86-87-88-89-90-91-96
CA 1410-11-12-13-14-15-16-17-24-25-26-27

10 € cad./each

ABX-A514

Ruote con freno - Wheels with catch
Roues avec frein - Räder mit Bremse

CA 1392P-93P-94P-95P

13 € cad./each

ABX-A517

Ruote con freno - Wheels with catch
Roues avec frein - Räder mit Bremse

CA 1430-31-32-33

17 € cad./each



ABX-A512

ABX-A514

ABX-CA1380 ABX-CA1381



ABX-CA1382 ABX-CA1383



ABX-CA1384 ABX-CA1385







IT Struttura tubolare 20x20 mm in acciaio inox AISI 304 - ripiani in acciaio inox AISI 304 piegati, satinati, insonorizzati - paracolpi in gomma - ruote multidirezionali \varnothing 125 mm.

FR Structure tubulaire 20x20 mm en acier inox AISI 304 - étagères en acier inox AISI 304 pliées, satinées, insonorisées - butoirs en caoutchouc - roues multidirectionnelles \varnothing 125 mm.

EN Tubular structure 20x20 mm in stainless steel AISI 304- AISI 304 stainless steel folded, satin-finished, soundproofed shelves - rubber shock absorber - multidirectional wheels \varnothing 125 mm.

DE Rohrrahmen 20x20 mm aus Edelstahl AISI 304 - Gebogene, Schallgedämmte Ablageflächen aus Edelstahl AISI 304 mit satiniertes Oberfläche - Gummistoßschutz - Mehrwegräder \varnothing 125 mm.

	ABX-CA1380	ABX-CA1381	ABX-CA1382	ABX-CA1383	ABX-CA1384	ABX-CA1385
 cm	91 x 57 x 172(h) cm	111 x 57 x 172(h) cm	91 x 57 x 96(h) cm	111 x 57 x 96(h) cm	91 x 57 x 96(h) cm	111 x 57 x 96(h) cm
 N.	4		2		3	
 mm	80 x 50 cm	100 x 50 cm	80 x 50 cm	100 x 50 cm	80 x 50 cm	100 x 50 cm
 MAX Kg	80 Kg		80 Kg		80 Kg	
	720 €	800 €	410 €	450 €	550 €	610 €

ABX-CA1390
ABX-CA1391



ABX-CA1410
ABX-CA1411



ABX-CA1412
ABX-CA1413
ABX-CA1414



IT Struttura tubolare \varnothing 25 mm in acciaio inox AISI 304 - ripiani in acciaio inox AISI 304, stampati in forma di vassoio con bordi arrotondati e alto spessore, insonorizzati e con finitura satinata - paracolpi in gomma - ruote multidirezionali \varnothing 125 mm.

FR Structure tubulaire \varnothing 25 mm en acier inox AISI 304 - étagères en acier inox AISI 304, moulées en forme de plateau à bords arrondis et de grande épaisseur, insonorisées et satinées - butoirs en caoutchouc - roues multidirectionnelles \varnothing 125 mm.

EN Tubular structure \varnothing 25 mm in stainless steel AISI 304 - AISI 304 stainless steel shelves, tray-shaped with rounded edges and high thickness, soundproofed and with satin finish - rubber shock absorber - multidirectional wheels \varnothing 125 mm.

DE Rohrrahmen \varnothing 25 mm aus Edelstahl AISI 304 - Schallgedämmte Ablageflächen aus Edelstahl AISI 304, Tablett förmig bedruckt mit abgerundeten Kanten und satinierter Oberfläche - Gummistoßschutz-Mehrwegräder \varnothing 125 mm.

	ABX-CA1390	ABX-CA1391	ABX-CA1410	ABX-CA1411	ABX-CA1412	ABX-CA1413	ABX-CA1414
	90 x 60 x 94(h) cm	110 x 60 x 94(h) cm	90 x 60 x 104(h) cm	110 x 60 x 104(h) cm	100 x 70 x 94(h) cm	110 x 70 x 94(h) cm	128 x 70 x 94(h) cm
	2		3		2		
	80 x 50 cm	100 x 50 cm	80 x 50 cm	100 x 50 cm	90 x 60 cm	100 x 60 cm	120 x 60 cm
	100 Kg		100 Kg		100 Kg		
	370 €	415 €	490 €	550 €	442 €	470 €	600 €



ABX-CA1415
ABX-CA1416
ABX-CA1417



ABX-CA1424
ABX-CA1425



ABX-CA1426
ABX-CA1427







IT Struttura tubolare \varnothing 25 mm in acciaio inox AISI 304 - ripiani in acciaio inox AISI 304, stampati in forma di vassoio con bordi arrotondati e alto spessore, insonorizzati e con finitura satinata - paracolpi in gomma - ruote multidirezionali \varnothing 125 mm.

EN Tubular structure \varnothing 25 mm in stainless steel AISI 304 - AISI 304 stainless steel shelves, tray-shaped with rounded edges and high thickness, soundproofed and with satin finish - rubber shock absorber - multidirectional wheels \varnothing 125 mm.

FR Structure tubulaire \varnothing 25 mm en acier inox AISI 304 - étagères en acier inox AISI 304, moulées en forme de plateau à bords arrondis et de grande épaisseur, insonorisées et satinées - butoirs en caoutchouc - roues multidirectionnelles \varnothing 125 mm.

DE Rohrrahmen \varnothing 25 mm aus Edelstahl AISI 304 - Schallgedämmte Ablageflächen aus Edelstahl AISI 304, Tablett förmig bedruckt mit abgerundeten Kanten und satinierter Oberfläche - Gummistoßschutz-Mehrwegräder \varnothing 125 mm.

	ABX-CA1415	ABX-CA1416	ABX-CA1417	ABX-CA1424	ABX-CA1425	ABX-CA1426	ABX-CA1416
	100 x 70 x 104(h) cm	110 x 70 x 104(h) cm	128 x 70 x 104(h) cm	90 x 60 x 140(h) cm	110 x 60 x 140(h) cm	90 x 60 x 170(h) cm	110 x 60 x 170(h) cm
	3			4		5	
	90 x 60 cm	100 x 60 cm	120 x 60 cm	80 x 50 cm	100 x 50 cm	80 x 50 cm	100 x 50 cm
	100 Kg			100 Kg		100 Kg	
	590 €	640 €	820 €	640 €	725 €	800 €	910 €

ABX-CA1390S ABX-CA1391S



* Sacchi non inclusi.
Bags not included.
Sacs non fournis.
Säcke nicht enthalten.

h 52 cm

ABX-CA1391S2



* Sacchi non inclusi.
Bags not included.
Sacs non fournis.
Säcke nicht enthalten.





h 52 cm





IT Portarifiuti. Carrelli di servizio in acciaio inox. Struttura tubolare \varnothing 25 mm in acciaio inox AISI 304 - ripiani in acciaio inox AISI 304 con fori per sacchi portarifiuti - paracolpi in gomma - ruote multidirezionali \varnothing 125 mm.

EN Garbage trolley. Stainless steel service trolleys. Tubular structure \varnothing 25 mm in stainless steel AISI 304 - stainless steel AISI 304 shelves with holes for garbage bags - rubber stop - multidirectional wheels \varnothing 125 mm.

FR Récipient à déchets. Chariots de service en acier inox Structure tubulaire \varnothing 25 mm en acier inox AISI 304 - étagères en acier inox AISI 304 avec trous pour sacs à déchets - butoir en caoutchouc - roues multidirectionnelles \varnothing 125 mm.

DE Abfallwagen. Servicewagen aus Edelstahl. Rohrrahmen \varnothing 25 mm aus Edelstahl AISI 304 - Ablageflächen aus Edelstahl AISI 304 mit Löchern für Abfallsäcke - Gummistoßschutz- Mehrwegräder \varnothing 125 mm.

	ABX-CA1390S	ABX-CA1391S
	90 x 60 x 94(h) cm	110 x 60 x 94(h) cm
	2	
	80 x 50 cm	100 x 50 cm
	100 Kg	
	450 €	480 €

	ABX-CA1391S2
	110 x 60 x 94(h) cm
	2
	100 x 50 cm
	100 Kg
	550 €

ABX-CA1152 ABX-CA1154

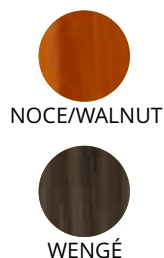

- IT** Carrelli di servizio con cupola. Struttura tubolare 20x20 mm in acciaio inox AISI 304 - ripiani in nobilitato con cornice perimetrale in acciaio inox AISI 304 - cupola in plexiglass semicircolare apribile su due lati - disponibile con ripiani colore noce o wengé - paracolpi in gomma - ruote multidirezionali \varnothing 125 mm.
- EN** Service trolleys with dome. Tubular structure 20x20 mm in stainless steel AISI 304 - melamine shelves with stainless steel AISI 304 perimeter frame - half-circle dome in Plexiglas that opens on two sides - available with walnut or wenge colour shelves - rubber shock absorber - multidirectional wheels \varnothing 125 mm.
- FR** Chariots de service avec clochette. Structure tubulaire 20x20 mm en acier inox AISI 304 - étagères en mélaminé avec cadre périmétral en acier inox AISI 304 - clochette en plexiglas semi-circulaire s'ouvrant sur deux côtés - disponible avec étagères en noyer ou wengé - butoir en caoutchouc - roues multidirectionnelles \varnothing 125 mm.
- DE** Servicewagen für Kuchen. Rohrrahmen 20x20 mm aus Edelstahl AISI 304 - Ablageflächen aus Melamin mit umlaufendem Rahmen aus Edelstahl AISI 304 - zweiseitig aufklappbare, halbrunde Plexiglashaube - mit Ablageflächen in Nussbaum- oder Wengé-Farbe erhältlich - Gummistoßschutz- Mehrwegräder \varnothing 125 mm.

	ABX-CA1152	ABX-CA1152W	ABX-CA1154	ABX-CA1154W
	90 x 57 x 110(h) cm		111 x 57 x 110(h) cm	
	2			
	60 Kg			
	630 €		670 €	

ABX-CA1390C ABX-CA1391C



- IT** Carrelli di servizio con cupola. Struttura tubolare \varnothing 25 mm in acciaio inox AISI 304 - ripiani in acciaio inox AISI 304, stampati, satinati e insonorizzati - cupola in plexiglass semicircolare apribile su due lati - paracolpi in gomma - ruote multidirezionali \varnothing 125 mm.
- EN** Service trolleys with dome. Tubular structure \varnothing 25 mm in stainless steel AISI 304 - stainless steel AISI 304 folded, satin-finished, soundproofed shelves - half-circle dome in Plexiglas that opens on two sides - rubber shock absorber - multidirectional wheels \varnothing 125 mm.
- FR** Chariots de service avec clochette. Structure tubulaire \varnothing 25 mm en acier inox AISI 304 - étagères en acier inox AISI 304 moulées, satinées, insonorisées - clochette en plexiglas semi-circulaire s'ouvrant sur deux côtés - butoir en caoutchouc - roues multidirectionnelles \varnothing 125 mm.
- DE** Servicewagen für Kuchen. Rohrrahmen \varnothing 25 mm aus Edelstahl AISI 304 - vorgeformte schallgedämmte Ablageflächen aus Edelstahl AISI 304 mit satiniertes Oberfläche - zweiseitig aufklappbare, halbrunde Plexiglashaube - Gummistoßschutz- Mehrwegräder \varnothing 125 mm.

	ABX-CA1390C	ABX-CA1391C
	90 x 60 x 109(h) cm	110 x 60 x 109(h) cm
	2	
	100 Kg	
	660 €	715 €

Carrelli di servizio in acciaio inox con cupola
Stainless steel service trolleys with dome

OPTIONAL



ABX-CA1162 ABX-CA1163



ABX-CA1165



IT Carrelli di servizio con cupola. Struttura tubolare 20x20 mm in acciaio inox AISI 304 - ripiani in acciaio inox AISI 304, stampati e insonorizzati - coperchio in plexiglass 150(h) mm - paracolpi in gomma - ruote multidirezionali \varnothing 120 mm.

EN Service trolleys with dome. Tubular structure 20x20 mm in stainless steel AISI 304 - stainless steel AISI 304 folded, satin-finished, soundproofed shelves - Plexiglas lid 150(h) mm - rubber shock absorber - multidirectional wheels \varnothing 120 mm.

FR Chariots de service avec clochette. Structure tubulaire 20x20 mm en acier inox AISI 304 - étagères en acier inox AISI 304 moulées, satinées, insonorisées - couvercle en plexiglas 150(h) mm - butoir en caoutchouc - roues multidirectionnelles \varnothing 120 mm.

DE Servicewagen für Kuchen. Rohrrahmen 20x20 mm aus Edelstahl AISI 304 - vorgeformte schallgedämmte Ablageflächen aus Edelstahl AISI 304 mit satiniertes Oberfläche - Deckel aus Plexiglas 150(h) mm - Gummistoßschutz- Mehrwegräder \varnothing 125 mm.

IT Carrello di servizio in acciaio inox con piastre eutettiche refrigeranti. Struttura tubolare in acciaio inox AISI 304 20x20 mm - 8 piastre eutettiche 150(h) mm - vasca e griglia in refrigerate incluse - coperchio in plexiglass acciaio inox - predisposto per una capacità di n. 5 bacinelle GN1/4 e n. 5 bacinelle GN1/6 65(h) mm. Bacinelle non incluse nel prezzo.

EN Stainless steel service trolley with refrigerated electric plates. Tubular structure 20x20 mm in stainless steel AISI 304 - 8 refrigerated eutectic plates included - Plexiglas lid 150(h) mm - stainless steel bowl and grid - equipped for up to 5 GN1/4 containers and 5 GN1/6 65(h) mm containers. Containers not included in the price.

FR Chariot de service en acier inox avec plaques de refroidissement électriques. Structure tubulaire en acier inox AISI 304 20x20 mm - 8 plaques eutectiques réfrigérées incluses - couvercle en plexiglas 150(h) mm - cuve et grille en acier inox - équipés pour une capacité de 5 bacs GN1/4 et 5 bacs GN1/6 65(h) mm. Bacs non compris dans le prix.

DE Edelstahl-Servicewagen mit elektrischen Kühlplatten. Rohrrahmen aus Edelstahl AISI 304 20x20 mm - 8 eutektische Kühlplatten im Lieferumfang enthalten - Plexiglasdeckel 150(h) mm - Edelstahlwanne und Gitter - enthält 5 GN1/4 Behälter mit 65(h) mm oder 5 GN1/6 Behälter mit 65(h) mm. Behälter nicht im Preis inbegriffen.

	ABX-CA1162	ABX-CA1163
	118 x 57 x 104(h) cm	
	2	3
	80 Kg	
	725 €	885 €

	ABX-CA1165
	108 x 57 x 104(h) cm
	2
	80 Kg
	1.200 €



ABX-CA1388



ABX-CA1389



IT Carrelli di servizio in acciaio inox per sbarazzo. Struttura tubolare in acciaio inox AISI 304, 20x20 mm - vasca in acciaio inox AISI 304 - piano inferiore in acciaio inox piegato - ruote multidirezionali ø 125 mm.

IT Carrelli di servizio in acciaio inox per sbarazzo. Struttura tubolare in acciaio inox AISI 304, 20x20 mm - vasche in acciaio inox AISI 304 insonorizzate 150(h) mm - ruote multidirezionali ø 125 mm.

EN Stainless steel service trolleys for disposal. Tubular structure in stainless steel AISI 304, 20x20 mm - stainless steel AISI 304 bowl - lower folded stainless steel shelf - multidirectional wheels ø 125 mm.

EN Stainless steel service trolleys for disposal. Tubular structure in stainless steel AISI 304, 20x20 mm - stainless steel AISI 304 soundproofed bowls 150(h) mm - multidirectional wheels ø 125 mm.







FR Chariots de service en acier inox pour le rangement. Structure tubulaire en acier inox AISI 304, 20x20 mm - cuve en acier inox AISI 304 - plateau inférieur courbé en acier inox - roues multidirectionnelles ø 125 mm.

FR Chariots de service en acier inox pour le rangement. Structure tubulaire en acier inox AISI 304, 20x20 mm - cuve en acier inox AISI 304 insonorisées 150(h) mm - plateau inférieur courbé en acier inox - roues multidirectionnelles ø 125 mm.

DE Servicewagen aus Edelstahl zum Abräumen. Rohrrahmen aus Edelstahl AISI 304, 20x20 mm - Wanne aus Edelstahl AISI 304 - Bodenfläche aus gebogenem Edelstahl - Mehrwegräder ø 125 mm.

DE Servicewagen aus Edelstahl zum Abräumen. Rohrrahmen aus Edelstahl AISI 304, 20x20 mm - schallgedämmte Wanne aus Edelstahl AISI 304 150(h) mm - Mehrwegräder ø 125 mm.

	ABX-CA1388
 cm	101 x 57 x 97(h) cm
 N.	2
 mm	90 x 50 cm
	1 x 150(h) mm
 MAX Kg	80 Kg
	540 €

	ABX-CA1389
 cm	101 x 57 x 97(h) cm
 N.	2
 mm	90 x 50 cm
	2 x 150(h) mm
 MAX Kg	80 Kg
	640 €

ABX-CA1396



- IT** Carrelli di servizio in acciaio inox per sbarazzo. Struttura tubolare in acciaio inox AISI 304, 20x20 mm - vasche insonorizzate in acciaio inox AISI 304 65(h) mm - ruote multidirezionali \varnothing 125 mm.
- EN** Stainless steel service trolleys for disposal. Tubular structure in stainless steel AISI 304, 20x20 mm - stainless steel AISI 304 soundproofed bowls, 65(h) mm - multidirectional wheels \varnothing 125 mm.
- FR** Chariots de service en acier inox pour le rangement. Structure tubulaire en acier inox AISI 304, 20x20 mm - cuve en acier inox AISI 304 insonorisées 65(h) mm - roues multidirectionnelles \varnothing 125 mm.
- DE** Servicewagen aus Edelstahl zum Abräumen. Rohrrahmen aus Edelstahl AISI 304, 20x20 mm - schallgedämmte Wanne aus Edelstahl AISI 304 65(h) mm - Mehrwegräder \varnothing 125 mm.

	ABX-CA1396
	91 x 57 x 97(h) cm
	2
	90 x 50 cm
	2 x 65(h) mm
	80 Kg
	500 €

ABX-CA1386 ABX-CA1387



- IT** Carrello portabacinelle con struttura tubolare tonda \varnothing 25 mm in acciaio inox AISI 304 - livello superiore adatto a contenere fino a 3 bacinelle GN1/1 o 2 bacinelle GN1/1 - piano inferiore in acciaio inox AISI 304, piegato e insonorizzato - paracolpi in gomma - ruote multidirezionali \varnothing 125 mm. Bacinelle escluse.
- EN** Containers trolley with round tubular frame \varnothing 25 mm in stainless steel AISI 304 - upper level designed to accommodate up to 3 GN1/1 or 2 GN1/1 containers - lower level in stainless steel AISI 304, folded and soundproofed - rubber shock absorber - multidirectional wheels \varnothing 125 mm. Containers not included.
- FR** Chariot porte-bacs avec structure tubulaire ronde \varnothing 25 mm en acier inox AISI 304 - niveau supérieur pour 3 bacs GN1/1 ou 2 bacs GN1/1 - niveau inférieur en acier inox AISI 304, plié et insonorisé - butoir en caoutchouc - roues multidirectionnel \varnothing 125 mm. Bacs non compris
- DE** Behälterhalterwagen mit Rohrrahmen \varnothing 25 mm aus Edelstahl AISI 304 - obere Ebene zur Aufnahme von bis zu 3 GN1/1 oder 2 GN1/1 Behälter - vorgeformte, schallgedämmte Bodenfläche aus Edelstahl - Gummistoßschutz - Mehrwegräder \varnothing 125 mm. Behälter nicht enthalten

	ABX-CA1386	ABX-CA1387
	77 x 62 x 97(h) cm	110 x 62 x 97(h) cm
	2	
	100 Kg	
	330 €	390 €



ABX-CA1430



ABX-CA1431



ABX-CA1432



IT Carrelli di servizio inox per trasporto pesante. Struttura tubolare tonda \varnothing 25 mm, in acciaio inox AISI 304 - ripiani in acciaio inox AISI 304, stampati in forma di vassoio con bordi arrotondati e alto spessore, insonorizzati e con finitura satinata - paracolpi in gomma - ruote multidirezionali \varnothing 125 mm.

EN Stainless steel service trolleys for heavy transport. Tubular structure \varnothing 25 mm in stainless steel AISI 304 AISI 304 stainless steel shelves, tray-shaped with rounded edges and high thickness, soundproofed and with satin finish - rubber shock absorber - multidirectional wheels \varnothing 125 mm.





FR Chariots de service inox pour le transport de poids. Structure tubulaire ronde \varnothing 25 mm en acier inox AISI 304 - étagères en acier inox AISI,304 moulées en forme de plateau à bords arrondis et de grande épaisseur, insonorisées et satinées - butoirs en caoutchouc - roues multidirectionnelles \varnothing 125 mm.

DE Servicewagen aus Edelstahl für Schwerlasten. Runder Rohrrahmen \varnothing 25 mm, aus Edelstahl AISI 304Schallgedämmte Ablageflächen aus Edelstahl AISI 304, Tablett förmig bedruckt mit abgerundeten Kanten und satiniertes Oberfläche - Gummistoßschutz- Mehrwegräder \varnothing 125 mm.

ABX-CA1433



A richiesta spediti anche smontati.
On request also shipped disassembled.

	ABX-CA1430	ABX-CA1431	ABX-CA1432	ABX-CA1433
 cm	110 x 60 x 100(h) cm		110 x 60 x 130(h) cm	110 x 60 x 160(h) cm
 N.	2	3	4	5
 mm	100 x 50 cm			
 MAX Kg	150 Kg			
	620 €	760 €	950 €	1.080 €

OPTIONAL



ABX-CA1392P ABX-CA1393P



ABX-A514

OPTIONAL



ABX-CA1394P ABX-CA1395P



IT Carrelli di servizio inox per trasporto pesante. Struttura tubolare in acciaio inox AISI 304 25x25 mm - ripiani in acciaio inox AISI 304, piegati con omega di rinforzo, satinati e insonorizzati - paracolpi in gomma - ruote multidirezionali \varnothing 125 mm.

EN Stainless steel service trolleys for heavy transport. Tubular structure 25x25 mm in stainless steel AISI 304-AISI 304 stainless steel, folded shelves with support omega, satin-finished and soundproofed - rubber shock absorber - multidirectional wheels \varnothing 125 mm.

FR Chariots de service inox pour le transport de poids. Structure tubulaire 25x25 mm en acier inox AISI 304 - étagères en acier inox AISI 304 pliées avec renforcement oméga, satinées et insonorisées - butoirs en caoutchouc - roues multidirectionnelles \varnothing 125 mm.

DE Servicewagen aus Edelstahl für Schwerlasten. Rohrrahmen 25x25 mm aus Edelstahl AISI 304 - mit Omega Verstärkung gebogene, schallgedämmte Ablageflächen aus Edelstahl AISI 304 mit satinierter Oberfläche - Gummistoßschutz - Mehrwegräder \varnothing 125 mm.

	ABX-CA1392P	ABX-CA1393P
	92 x 67 x 98(h) cm	112 x 67 x 98(h) cm
	2	
	80 x 60 cm	100 x 60 cm
	200 Kg	
	620 €	670 €

	ABX-CA1394P	ABX-CA1395P
	92 x 67 x 98(h) cm	112 x 67 x 98(h) cm
	3	
	80 x 60 cm	100 x 60 cm
	200 Kg	
	860 €	950 €

ABX-CP1008



IT Carrelli di servizio multiuso in plastica con montanti in alluminio anodizzato.

EN Multipurpose plastic service trolleys with anodised aluminium uprights.

FR Chariots polyvalente en plastique avec montants en aluminium anodisé.

DE Mehrzweck-Servicewagen aus Kunststoff mit Trägern aus eloxiertem Aluminium.

Carrelli di servizio multiuso in plastica
Multipurpose plastic service trolleys

	ABX-CP1008
	85 x 43 x 95(h) cm
	3
	40 Kg
	110 €

ABX-CP1010



WARNING

ABX-A1001	ABX-A1002
Cestino piccolo / Small basket Petit panier / Klein Korb	Cestino grande / Big basket Grand panier / Gros Korb
12 €	28 €

IT Carrelli di servizio multiuso in plastica.

EN Multipurpose plastic service trolleys.

FR Chariots polyvalente en plastique.

DE Mehrzweck-Servicewagen aus Kunststoff.

	ABX-CP1010
	102 x 50 x 96(h) cm
	3
	40 Kg
	160 €



Il carrello in foto è con optional A1001 e A1002
The trolley shown is equipped with optional A1001 and A1002
Le chariot illustré est équipé avec A1001 et A1002
Der abgebildete Wagen ist mit A1001 und A1002ausgestattet



Carrelli ed Espositori refrigerati e termici in legno



ABX-CLR2788NW



IT Carrelli refrigerati in legno con cupola in plexiglass. Struttura in legno multistrato di betulla - cupola semicircolare in plexiglass - refrigerazione statica - modelli con 2 mensole ripieghevoli - colore noce o wengé - ruote multidirezionali ø 100 mm. Bacinelle escluse - le temperature di lavoro indicate sono da considerarsi con coperchi posizionati.

EN Wooden refrigerated trolleys with Plexiglas dome. Multi-layered birch wood structure - half-round Plexiglas dome - static refrigeration - two foldable shelves models - walnut or wenge colour - multidirectional wheels ø 100 mm. Basins excluded - the indicated working temperatures are to be considered with positioned lids.

FR Chariots réfrigérés n bois avec clochette en plexiglas. Structure en multicouche de bouleau - clochette en plexiglas semi-circulaire - réfrigération statique - modèles avec 2 étagères escamotables - couleur noyer ou wengé - roues multidirectionnelles ø 100 mm. Bacs non compris - les températures de travail indiquées sont à considérer avec couvercles en place.

DE Kühlwagen aus Holz mit Plexiglashaube. Birkensperrholzstruktur - halbrunde Plexiglashaube - statische Kühlung - Modelle mit 2 Faltflächen - erhältlich in Walnuss oder Wenge - Mehrwegräder ø 100 mm. Behälter nicht enthalten - die angegebenen Arbeitstemperaturen sind bei aufgesetzten Deckeln zu verstehen.







NOCE/WALNUT

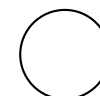

WENGÉ



BIANCO/WHITE

	ABX-CLR2788N noce-walnut	ABX-CLR2788NW wengé	ABX-CLR2788NB bianco-white	ABX-CLR2788NBT noce-walnut	ABX-CLR2788NBTW wengé	ABX-CLR2788NBTB bianco-white
 1 Ph	230V - 50Hz					
	+2°C +10°C			-5°C +5°C		
	R600a					
	3 x GN1/1 - 150(h) mm					
	3.495 €	3.720 €	3.850 €	3.850 €	3.940 €	3.940 €

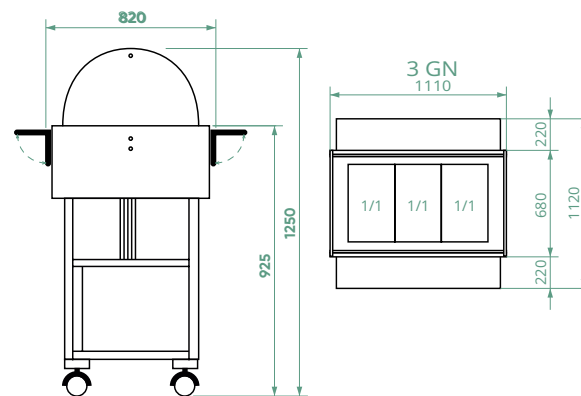

ABX-CLR2787N



IT Carrelli refrigerati in legno con cupola in plexiglass. Struttura in legno multistrato di betulla - cupola semicircolare in plexiglass - refrigerazione statica - modelli disponibili con 1 mensola ripieghevole e 1 piano di appoggio - colore noce o wengé - ruote multidirezionali Ø 100 mm. Bacinelle escluse - le temperature di lavoro indicate sono da considerarsi con coperchi posizionati.

EN Wooden refrigerated trolleys with Plexiglas dome. Multi-layered birch wood structure - half-round Plexiglas dome - static refrigeration - models with foldable shelf and support base - walnut or wenge colour - multidirectional wheels Ø 100 mm. Containers not included - the operating temperatures listed are to be considered with lids on.

FR Chariots réfrigérés n bois avec clochette en plexiglas. Structure en multicouche de bouleau - clochette en plexiglas semi-circulaire - réfrigération statique - modèles avec 1 étagère et plan de travail - couleur noyer ou wengé - roues multidirectionnelles Ø 100 mm. Bacs no compris - les températures de travail indiquées sont à considérer avec couvercles en place.

DE Kühlwagen aus Holz mit Plexiglashaube. Birkensperrholzstruktur - halbrunde Plexiglashaube - statische Kühlung - Modelle mit 1 Faltfläche und 1 Ablagefläche - erhältlich in Walnuss oder Wenge - Mehrwegräder Ø 100 mm. Behälter nicht enthalten - die angegebenen Arbeitstemperaturen sind bei aufgesetzten Deckeln zu verstehen.





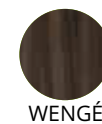

NOCE/WALNUT



WENGÉ



BIANCO/WHITE

	ABX-CLR2787N noce-walnut	ABX-CLR2787NW wengé	ABX-CLR2787NB bianco-white	ABX-CLR2787NBTB noce-walnut	ABX-CLR2787NBT wengé	ABX-CLR2787NBTB bianco-white
						
	230V - 50Hz					
	+2°C +10°C			-5°C +5°C		
	R600a					
	3 x GN1/1 - 150(h) mm					
	3.470 €	3.685 €		3.800 €		4.010 €

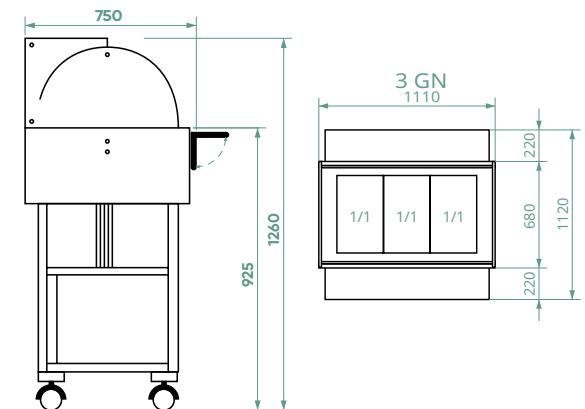



ABX-CLR2786NB

NEW



IT Carrelli refrigerati in legno con luce al neon. Struttura in legno multistrato di betulla - cupola in plexiglass - refrigerazione statica - 2 mensole ripieghevoli - disponibili nei colori noce o wengé - 1 luce al neon - ruote multidirezionali ø 100 mm. Bacinelle escluse - le temperature di lavoro indicate sono da considerarsi con coperchi posizionati.

EN Refrigerated wooden trolleys with neon light. Multi-layered birch wood structure - half-round Plexiglas dome - static refrigeration - 2 foldable shelves - available in walnut or wenge colour - 1 neon light - multidirectional wheels ø 100 mm. Containers not included - the operating temperatures listed are to be considered with lids on.

FR Chariots réfrigérés en bois avec lampe néon. Structure en multicouche de bouleau - clochette en plexiglas - réfrigération statique - 2 étagères escamotables - couleur noyer ou wengé - 1 lampe néon - roues multidirectionnelles ø 100 mm. Bacs non compris - les températures de travail indiquées sont à considérer avec couvercles en place.

DE Kühlwagen aus Holz mit Neonlampe. Birkensperrholzstruktur - Plexiglashaube - statische Kühlung - 2 faltflächen- erhältlich in Walnuss oder Wenge - 1 Neonlampe - Mehrwegräder ø 100 mm. Behälter nicht enthalten - die angegebenen Arbeitstemperaturen sind bei aufgesetzten Deckeln zu verstehen



NOCE/WALNUT

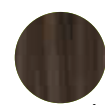

WENGÉ

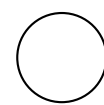

BIANCO/WHITE

	ABX-CLR2786N noce-walnut	ABX-CLR2786NW wengé	ABX-CLR2786NB bianco-white	ABX-CLR2786NBT noce-walnut	ABX-CLR2786NBTW wengé	ABX-CLR2786NBTB bianco-white
 1 Ph	230V - 50Hz					
	+2°C +10°C			-5°C +5°C		
	R600a					
	3 x GN1/1 - 150(h) mm					
	3.640 €		3.810 €		3.930 €	4.210 €

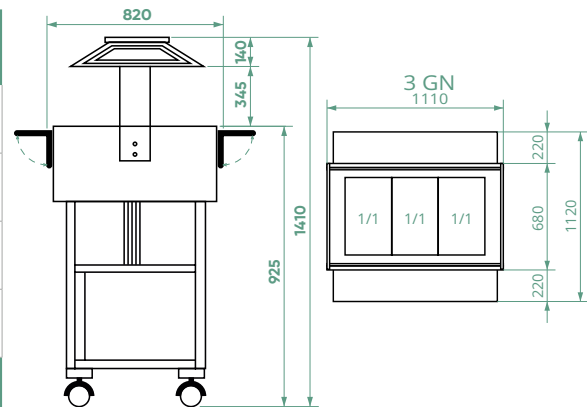

ABX-ELR2827



ABX-ELR2827BTW

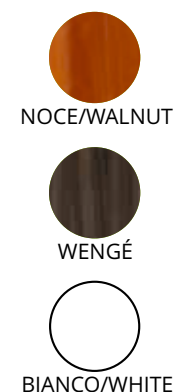





IT Espositori refrigerati in legno con cupola. Struttura in legno multistrato di betulla - cupola semicircolare in plexiglass - refrigerazione statica - disponibili con 2 mensole ripieghevoli - colore noce o wengé - ruote multidirezionali \varnothing 75 mm. Bacinelle escluse - le temperature di lavoro indicate sono da considerarsi con coperchi posizionati.

FR Présentoirs réfrigérés en bois avec clochette. Structure en multicouche de bouleau - clochette en plexiglas semi-circulaire - réfrigération statique - modèles avec 2 étagères escamotables - couleur noyer ou wengé - roues multidirectionnelles \varnothing 75 mm. Bacs non compris - les températures de travail indiquées sont à considérer avec couvercles en place.

EN Refrigerated wooden displays with dome. Multi-layered birch wood structure - half-round Plexiglas dome - static refrigeration - two foldable shelves models - walnut or wenge colour - multidirectional wheels \varnothing 100 mm. Containers not included - the operating temperatures listed are to be considered with lids on.

DE Kühlvitrinen aus Holz mit Haube. Birkensperrholzstruktur - halbrunde Plexiglashaube - statische Kühlung - mit 2 Faltflächen- erhältlich in Walnuss oder Wenge - Mehrwegräder \varnothing 75 mm. Behälter nicht enthalten - die angegebenen Arbeitstemperaturen sind bei aufgesetzten Deckeln zu verstehen.

	ABX-ELR2827 noce-walnut	ABX-ELR2827W wengé	ABX-ELR2827B bianco-white	ABX-ELR2827BT noce-walnut	ABX-ELR2827BTW wengé	ABX-ELR2827BTB bianco-white
						
 1 Ph	230V - 50Hz					
	+2°C +10°C			-5°C +5°C		
	R600a					
	4 x GN1/1 - 150(h) mm					
	3.640 €	3.820 €		4.000 €		4.190 €

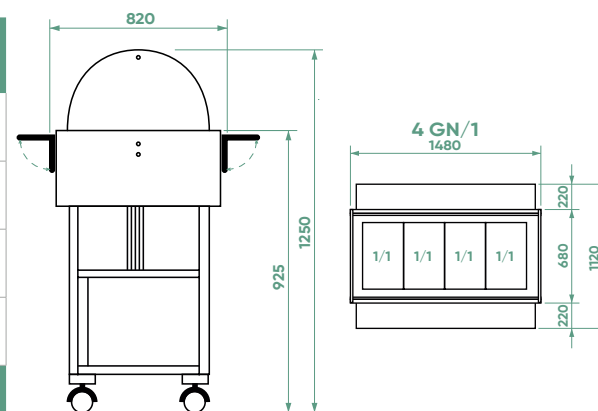

ABX-ELR2826



ABX-ELR2826BTW

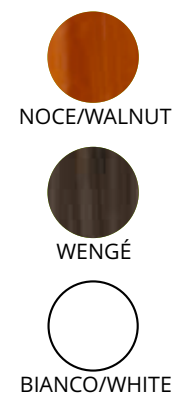





IT Espositori refrigerati in legno con cupola. Struttura in legno multistrato di betulla - cupola semicircolare in plexiglass - refrigerazione statica - disponibili con 1 mensola ripieghevole e 1 piano di appoggio - colore noce o wengé - ruote multidirezionali \varnothing 75 mm. Bacinelle escluse - le temperature di lavoro indicate sono da considerarsi con coperchi posizionati.

EN Refrigerated wooden displays with dome. Multi-layered birch wood structure - half-round Plexiglas dome - static refrigeration - models with 1 foldable shelf and 1 support base - walnut or wenge colour - multidirectional wheels \varnothing 75 mm. Containers not included - the operating temperatures listed are to be considered with lids on.

FR Présentoirs réfrigérés en bois avec clochette. Structure en multicouche de bouleau - clochette en plexiglas semi-circulaire - réfrigération statique - avec 1 étagère escamotable et plan de travail - couleur noyer ou wengé - roues multidirectionnelles \varnothing 75 mm. Bacs non compris - les températures de travail indiquées sont à considérer avec couvercles en place.

DE Kühlvitrinen aus Holz mit Haube. Birkensperrholzstruktur - halbrunde Plexiglashaube - statische Kühlung - Modelle mit 1 faltfläche und 1 Ablagefläche - erhältlich in Walnuss oder Wenge - Mehrwegräder \varnothing 75 mm. Behälter nicht enthalten - die angegebenen Arbeitstemperaturen sind bei aufgesetzten Deckeln zu verstehen.

	ABX-ELR2826 noce-walnut	ABX-ELR2826W wengé	ABX-ELR2826B bianco-white	ABX-ELR2826BT noce-walnut	ABX-ELR2826BTW wengé	ABX-ELR2826BTB bianco-white
 1 Ph	230V - 50Hz					
	+2°C +10°C			-5°C +5°C		
	R600a					
	4 x GN1/1 - 150(h) mm					
	3.615 €	3.820 €		3.970 €		4.165 €

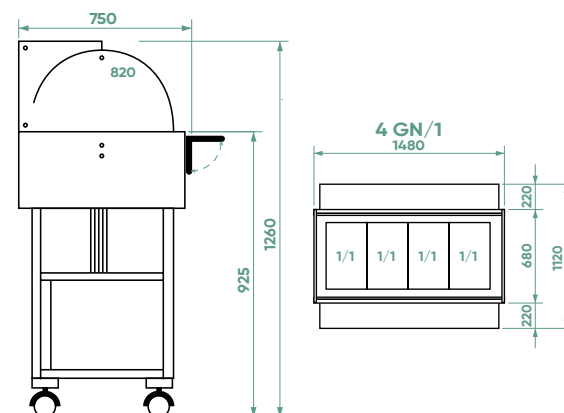

ABX-ELR2825



ABX-ELR2825BTW

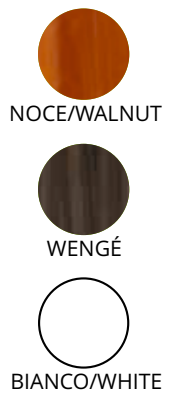





IT Espositori refrigerati in legno con luce al neon. Struttura in legno multistrato di betulla - cupola in plexiglass - refrigerazione statica - 2 mensole ripieghevoli - disponibile nei colori noce o wengé - 1 luce al neon - ruote multidirezionali \varnothing 75 mm. Bacinelle escluse - le temperature di lavoro indicate sono da considerarsi con coperchi posizionati.

FR Présentoirs réfrigérés en bois avec lampe néon. Structure en multicouche de bouleau - clochette en plexiglas - réfrigération statique - 2 étagères escamotables - disponible en couleur noyer ou wengé - 1 lampe néon - roues multidirectionnelles \varnothing 75 mm. Bacs non compris - les températures de travail indiquées sont à considérer avec couvercles en place.

EN Refrigerated wooden displays with neon light. Multi-layered birch wood structure - Plexiglas dome - static refrigeration - 2 foldable shelves - available in walnut or wenge colour - 1 neon light - multidirectional wheels \varnothing 75 mm. Containers not included - the operating temperatures listed are to be considered with lids on.

DE Kühlvitrinen aus Holz mit Neonlampe. Birkensperrholzstruktur - Plexiglashaube - statische Kühlung - 2 faltflächen - erhältlich in Walnuss oder Wenge - 1 Neonlampe - Mehrwegräder \varnothing 75 mm. Behälter nicht enthalten - die angegebenen Arbeitstemperaturen sind bei aufgesetzten Deckeln zu verstehen.

	ABX-ELR2825 noce-walnut	ABX-ELR2825W wengé	ABX-ELR2825B bianco-white	ABX-ELR2825BT noce-walnut	ABX-ELR2825BTW wengé	ABX-ELR2825BTB bianco-white
						
	230V - 50Hz					
	+2°C +10°C			-5°C +5°C		
	R600a					
	4 x GN1/1 - 150(h) mm					
	3.810 €	3.910 €		4.235 €		4.250 €

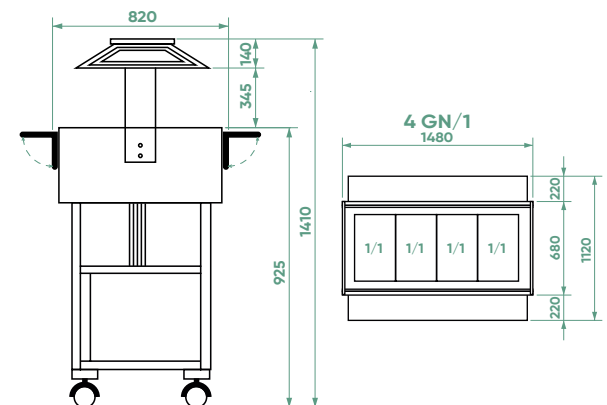

ABX-CL2777NW



IT Carrelli termico a bagnomaria in legno, con cupola. Struttura in legno multistrato di betulla - cupola semicircolare in plexiglass - riscaldato con resistenza elettrica- disponibili con 2 mensole ripieghevoli - colore noce o wengé - ruote multidirezionali \varnothing 100 mm. Bacinelle escluse - le temperature di lavoro indicate sono da considerarsi con coperchi posizionati.

EN Wooden heated bain-marie trolleys with dome. Multi-layered birch wood structure - half-round Plexiglas dome - electric heating element - available with two foldable shelves - walnut or wenge colour - multidirectional wheels \varnothing 100 mm. Containers not included - the operating temperatures listed are to be considered with lids on.

FR Wooden heated bain-marie trolleys with dome. Multi-layered birch wood structure - half-round Plexiglas dome - electric heating element - available with two foldable shelves - walnut or wenge colour - multidirectional wheels \varnothing 100 mm. Containers not included - the operating temperatures listed are to be considered with lids on.

DE Bain-Marie Heizwagen aus Holz mit Haube. Birkensperrholzstruktur - halbrunde Plexiglashaube - mit elektrischem Heizstab beheizt - mit 2 faltflächen- erhältlich in Walnuss oder Wenge - Mehrwegräder \varnothing 100 mm. Behälter nicht enthalten - die angegebenen Arbeitstemperaturen sind bei aufgesetzten Deckeln zu verstehen.



NOCE/WALNUT





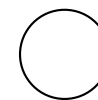

WENGÉ



BIANCO/WHITE

Carrelli termici a bagnomaria in legno Wooden bain-marie trolleys

	ABX-CL2777N noce-walnut	ABX-CL 2777NW wengé	ABX-CL2777NB bianco-white
	2000 W		
 1 Ph	230V - 50Hz		
	+30°C +90°C		
 N.	3 x GN1/1 - 150(h) mm		
	2.550 €		2.715 €

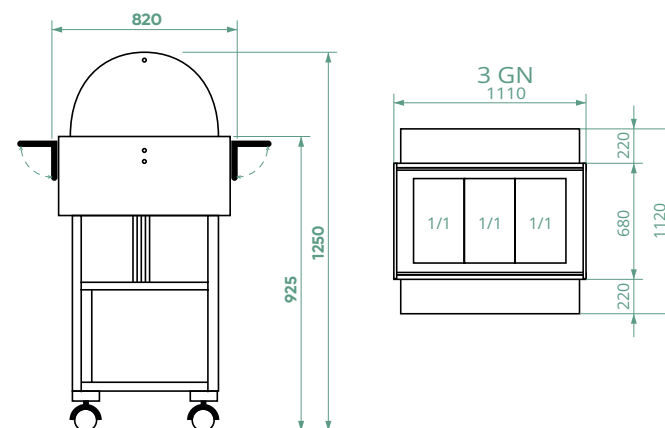

ABX-CL2778N







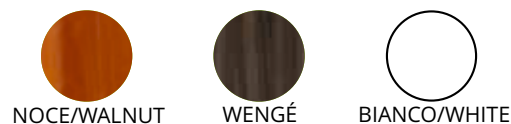

IT Carrelli termico a bagnomaria in legno, con cupola. Struttura in legno multistrato di betulla - cupola semicircolare in plexiglass - riscaldato con resistenza elettrica - disponibili con 1 mensola ripieghevole e 1 piano di appoggio - colore noce o wengé - ruote multidirezionali ø 100 mm. Bacinelle escluse - le temperature di lavoro indicate sono da considerarsi con coperchi posizionati.

EN Wooden heated bain-marie trolleys with dome. Multi-layered birch wood structure - half-round Plexiglas dome - electric heating element - available with 1 foldable shelf and 1 support base - walnut or wenge colour - multidirectional wheels ø 100 mm. Containers not included - the operating temperatures listed are to be considered with lids on.

FR Chariots bain-marie chauffants en bois avec clochette. Structure en multicouche de bouleau - clochette en plexiglas semi-circulaire - chauffé par résistance électrique - disponibles avec 1 étagère escamotable et 1 plan de travail - couleur noyer ou wengé - roues multidirectionnelles ø 100 mm. Bacs non compris - les températures de travail indiquées sont à considérer avec couvercles en place.

DE Bain-Marie Heizwagen aus Holz mit Haube. Birkensperholzstruktur - halbrunde Plexiglashaube - mit elektrischem Heizstab beheizt - mit 1 faltfläche und 1 Ablagefläche - erhältlich in Walnuss oder Wenge - Mehrwegräder ø 100 mm. Behälter nicht enthalten - die angegebenen Arbeitstemperaturen sind bei aufgesetzten Deckeln zu verstehen.



	ABX-CL2778N noce-walnut	ABX-CL 2778NW wengé	ABX-CL2778NB bianco-white
	2000 W		
 1 Ph	230V - 50Hz		
	+30°C +90°C		
	3 x GN1/1 - 150(h) mm		
	2.520 €		2.710 €

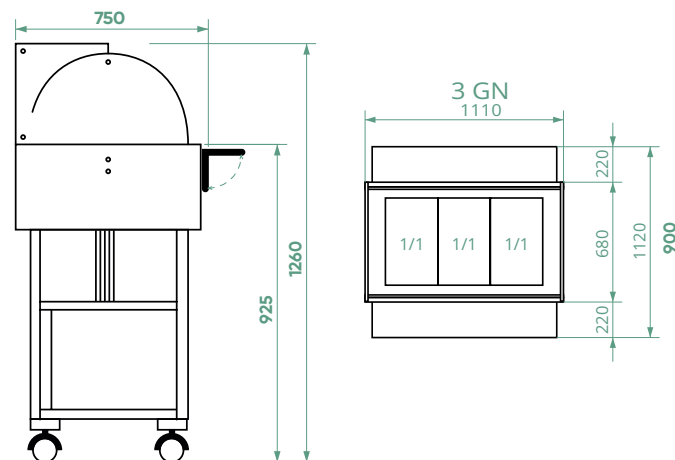

ABX-CL2774NW



- IT** Carrello termico a bagnomaria in legno, da buffet. Struttura in legno multistrato di betulla - cupola in plexiglass - luce al neon - riscaldato con resistenza elettrica - disponibili con 2 mensole ripieghevoli colore noce o wengé - ruote multidirezionali \varnothing 100 mm. Bacinelle escluse - le temperature di lavoro indicate sono da considerarsi con coperchi posizionati.
- EN** Wooden heated bain-marie trolley, for buffet. Multi-layered birch wood structure - half-round Plexiglas dome - neon light - electric heating element - available with two foldable shelves - walnut or wenge colour - multidirectional wheels \varnothing 100 mm. Containers not included - the operating temperatures listed are to be considered with lids on.
- FR** Chariots bain-marie chauffants en bois, pour buffet. Structure en multicouche de bouleau - clochette en plexiglas - lampe néon - chauffé par résistance électrique - disponibles avec 2 étagères escamotables - couleur noyer ou wengé - roues multidirectionnelles \varnothing 100 mm. Bacs non compris - les températures de travail indiquées sont à considérer avec couvercles en place.
- DE** Bain-Marie Heizwagen aus Holz für Buffets. Birkensperrholzstruktur - Plexiglashaube - Neonlampe - mit elektrischem Heizstab beheizt - mit 2 Faltflächen - erhältlich in Walnuss oder Wenge - Mehrwegräder \varnothing 100 mm. Behälter nicht enthalten - die angegebenen Arbeitstemperaturen sind bei aufgesetzten Deckeln zu verstehen.



NOCE/WALNUT

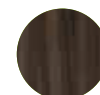





WENGÉ

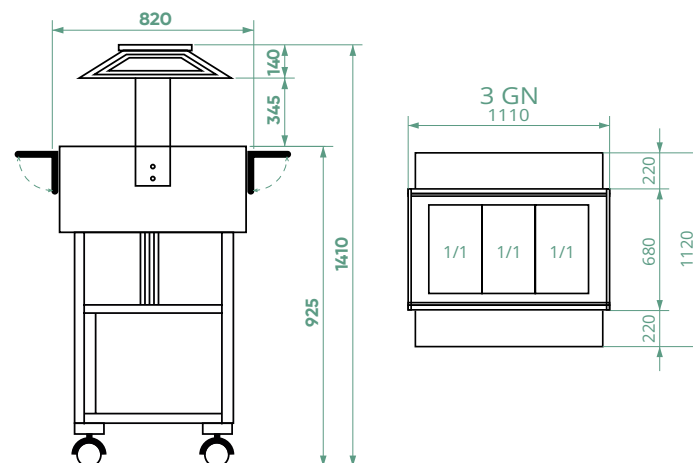

BIANCO/WHITE



	ABX-CL2774N noce-walnut	ABX-CL 2774NW wengé	ABX-CL2774NB bianco-white
			
		2000 W	
 1 Ph		230V - 50Hz	
		+30°C +90°C	
		3 x GN1/1 - 150(h) mm	
	2.710 €		2.940 €

Carrelli termici a bagnomaria in legno
Wooden heated bain-marie trolleys

ABX-CL2772N



NOCE/WALNUT



IT Carrello termico a bagnomaria in legno. Struttura in legno multistrato di betulla - 1 mensola ripieghevole - disponibile in colore noce - ruote multidirezionali \varnothing 100 mm. Bacinelle escluse - le temperature di lavoro indicate sono da considerarsi con coperchi posizionati.

EN Wooden heated bain-marie trolley Multi-layered birch wood structure - 1 folding shelf - available in walnut colour - multidirectional wheels \varnothing 100 mm. Containers not included - the operating temperatures listed are to be considered with lids on.

FR Chariots bain-marie chauffants en bois. Structure en bois massif - 1 étagère escamotable - disponible en couleur noyer - roues multidirectionnelles de \varnothing 100 mm. Bacs non compris - les températures de travail indiquées sont à considérer avec couvercles en place.

DE Bain-Marie Heizwagen aus Holz. Birkensperholzstruktur - 1 faltfläche - erhältlich in Walnussfarbe - Mehrwegräder \varnothing 100 mm. Behälter nicht enthalten - die angegebenen Arbeitstemperaturen sind bei aufgesetzten Deckeln zu verstehen.

	ABX-CL2772N noce-walnut
	2000 W
 1 Ph	230V - 50Hz
	+30°C +90°C
	3 x GN1/1 - 150(h) mm
	123 x 70 x 135(h) cm
	2.220 €





ABX-ELC2832



ABX-ELC2832W

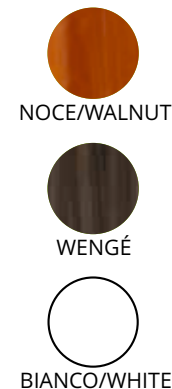





IT Espositore termico a bagnomaria in legno, con cupola. Struttura in legno multistrato di betulla - cupola semicircolare in plexiglass - riscaldato con resistenza elettrica- disponibili con 2 mensole ripieghevoli - colore noce o wengé - ruote multidirezionali \varnothing 75 mm. Bacinelle escluse - le temperature di lavoro indicate sono da considerarsi con coperchi posizionati.

FR Présentoir bain-marie chauffants en bois avec clochette. Structure en multicouche de bouleau - clochette en plexiglas semi-circulaire - chauffé par résistance électrique - disponibles avec 2 étagères escamotables - couleur noyer ou wengé - roues multidirectionnelles \varnothing 75 mm. Bacs non compris - les températures de travail indiquées sont à considérer avec couvercles en place.

EN Wooden heated bain-marie display with dome. Multi-layered birch wood structure - half-round Plexiglas dome - electric heating element - available with two foldable shelves - walnut or wenge colour - multidirectional wheels \varnothing 75 mm. Containers not included - the operating temperatures listed are to be considered with lids on.

DE Bain-Marie Heizvitrine aus Holz mit Haube. Birkensperrholzstruktur - halbrunde Plexiglashaube - mit elektrischem Heizstab beheizt - mit 2 Faltflächen- erhältlich in Walnuss oder Wenge - Mehrwegräder \varnothing 75 mm. Behälter nicht enthalten - die angegebenen Arbeitstemperaturen sind bei aufgesetzten Deckeln zu verstehen.

	ABX-ELC2832 noce-walnut	ABX-ELC2832W wengé	ABX-ELC2832B bianco-white
	2000 W		
 1 Ph	230V - 50Hz		
	+30°C +90°C		
 N.	4 x GN1/1 - 150(h) mm		
	2.700 €		2.870 €

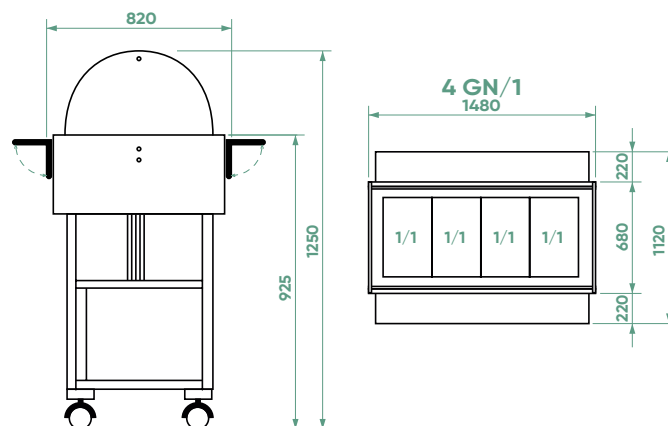

Espositori termici a bagnomaria in legno
Wooden heated bain-marie displays

OPTIONAL



ABX-ELC2834B

NEW



ABX-ELC2834

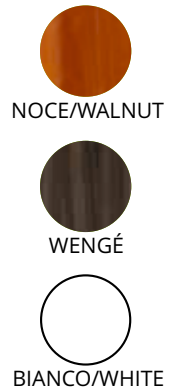





IT Espositore termico a bagnomaria in legno, con cupola. Struttura in legno multistrato di betulla - cupola semicircolare in plexiglass - riscaldato con resistenza elettrica - disponibili con 1 mensola ripieghevole e 1 piano di appoggio - colore noce o wengé - ruote multidirezionali \varnothing 75 mm. Bacinelle escluse - le temperature di lavoro indicate sono da considerarsi con coperchi posizionati.

FR Présentoir bain-marie chauffants en bois avec clochette. Structure en multicouche de bouleau - clochette en plexiglas semi-circulaire - chauffé par résistance électrique - disponibles avec 1 étagère escamotable et 1 plan de travail - couleur noyer ou wengé - roues multidirectionnelles \varnothing 75 mm. Bacs non compris - les températures de travail indiquées sont à considérer avec couvercles en place.

EN Wooden heated bain-marie display with dome. Multi-layered birch wood structure - half-round Plexiglas dome - electric heating element - available with 1 foldable shelf and 1 support base - walnut or wengé colour - multidirectional wheels \varnothing 75 mm. Containers not included - the operating temperatures listed are to be considered with lids on.

DE Bain-Marie Heizvitrine aus Holz mit Haube. Birkensperrholzstruktur - halbrunde Plexiglashaube - mit elektrischem Heizstab beheizt - mit 1 Faltfläche und 1 Ablagefläche- erhältlich in Walnuss oder Wenge - Mehrwegräder \varnothing 75 mm. Behälter nicht enthalten - die angegebenen Arbeitstemperaturen sind bei aufgesetzten Deckeln zu verstehen.

	ABX-ELC2834 noce-walnut	ABX-ELC2834W wengé	ABX-ELC2834B bianco-white
	2000 W		
 1 Ph	230V - 50Hz		
	+30°C +90°C		
 N.	4 x GN1/1 - 150(h) mm		
	2.900 €		3.010 €

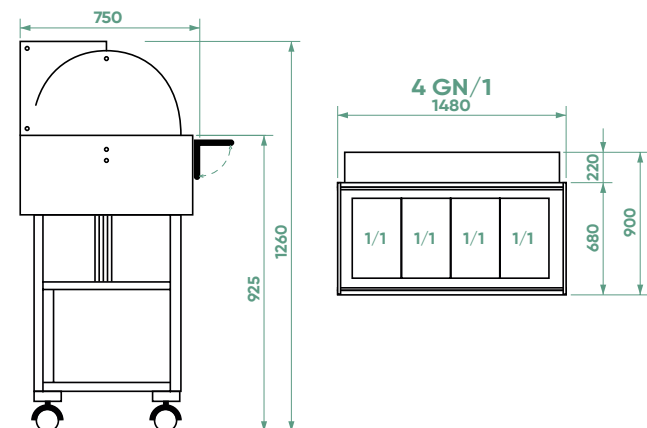

ABX-ELC2828



ABX-ELC2828W

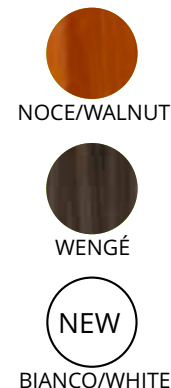





IT Espositore termico a bagnomaria in legno, con luce al neon. Struttura in legno multistrato di betulla - cupola in plexiglass - luce al neon - riscaldato con resistenza elettrica - disponibili con 2 mensole ripieghevoli - colore noce o wengé - ruote multidirezionali \varnothing 75 mm. Bacinelle escluse - le temperature di lavoro indicate sono da considerarsi con coperchi posizionati.

FR Présentoir bain-marie chauffants en bois, avec lampe néon. Structure en multicouche de bouleau - clochette en plexiglas - lampe néon - chauffé par résistance électrique - disponibles avec 2 étagères escamotables - couleur noyer ou wengé - roues multidirectionnelles \varnothing 75 mm. Bacs non compris - les températures de travail indiquées sont à considérer avec couvercles en place.

EN Wooden heated bain-marie display with neon light. Multi-layered birch wood structure - half-round Plexiglas dome - neon light - electric heating element - available with two foldable shelves - walnut or wengé colour - multidirectional wheels \varnothing 75 mm. Containers not included - the operating temperatures listed are to be considered with lids on.

DE Bain-Marie Heizvitrine aus Holz mit Neonlampe. Birkensterrholzstruktur - Plexiglashaube - Neonlampe - mit elektrischem Heizstab beheizt - mit 2 Faltflächen - erhältlich in Walnuss oder Wenge - Mehrwegräder \varnothing 75 mm. Behälter nicht enthalten - die angegebenen Arbeitstemperaturen sind bei aufgesetzten Deckeln zu verstehen.

	ABX-ELC2828 noce-walnut	ABX-ELC2828W wengé	ABX-ELC2828B bianco-white
		2000 W	
 1 Ph		230V - 50Hz	
		+30°C +90°C	
 N.		4 x GN1/1 - 150(h) mm	
	2.885 €		3.120 €

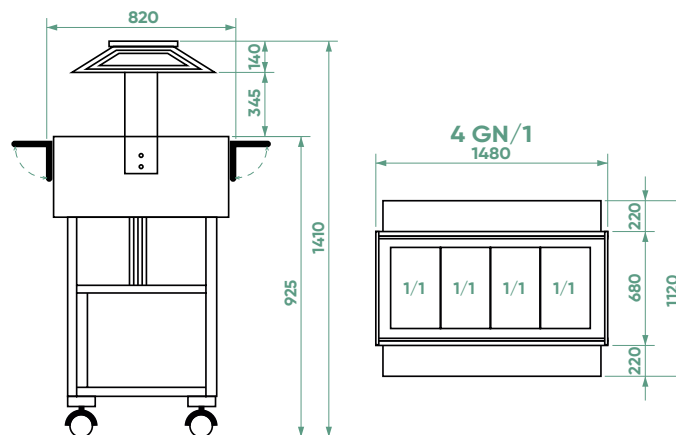

ABX-ELN2835

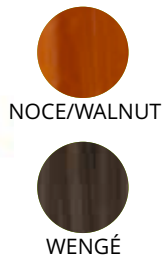







- IT** Espositore in legno neutro. Struttura in multistrato di betulla - cupola in plexiglas - piano in acciaio inox AISI 304 dotato di 2 mensole ripieghevoli - ruote multidirezionali \varnothing 75 mm.
- EN** Display in neutral wood. Multi-layered birch wood structure - Plexiglas dome - top in stainless steel AISI 304 - with 2 folding shelves - multidirectional wheels \varnothing 75 mm.
- FR** Présentoir en bois neutre. Structure en en bouleau multicouche - clochette en plexiglas - plan de travail en acier inox AISI 304 - avec 2 étagères escamotables - roues multidirectionnelles \varnothing 75 mm.
- DE** Neutral Vitrine aus Holz. Birkensperrholzstruktur - Plexiglashaube - Fläche aus Edelstahl AISI 304 - mit 2 Falflächen - Mehrwegräder \varnothing 75 mm.

	ABX-ELN2835 noce-walnut	ABX-ELN 2835W wengé
	147 x 82 x 141/(h) cm	
	2.280 €	

ABX-CL2770N



- IT** Carrello termico in legno, ideale per bolliti e arrostiti. Struttura portante in legno multistrato di betulla - vasca in acciaio inox AISI 304 munita di scarico. Bacinelle escluse
- EN** Wooden heated trolley, ideal for boiled and roasted meats. Multi-layered birch wood structure - stainless steel AISI 304 bowl with drain. Containers not included.
- FR** Chariot chauffant en bois, idéal pour les viandes bouillies et rôties. Structure portante en multicouche de bouleau - cuve en acier inox AISI 304 avec vidange. Bacs non compris
- DE** Heizwagen aus Holz, ideal für gekochtes und gebratenes Fleisch. Birkensperrholztragstruktur - Becken aus Edelstahl AISI 304 mit Ablauf. Behälter nicht enthalten

	ABX-CL2770N noce-walnut	ABX-CL2770NW wengé	ABX-CL2770NB bianco-white
	2000 W		
	230V - 50Hz		
	+30°C +90°C		
	3x GN1/1 150(h) mm		
	123 x 65 x 95(h) cm		
	1.930 €		2.075 €

Carrelli di servizio in legno Wooden service trolleys

ABX-CLR311	
Mod.	ABX-CLR2788 ABX-CLR2787 ABX-CLR2786 ABX-CLR2777 ABX-CLR2778 ABX-CLR2774 ABX-CLR2772 ABX-CLR2770
	Vasca inox forata Stainless steel perforated container Bac inox perforée Behälter aus rostfreiem Stahl mit Löcher
	GN3x1/1 - 100(h) mm
	160 €

ABX-CF411	
Mod.	ABX-ELR2827 ABX-ELR2826 ABX-ELR2825 ABX-ELR2832 ABX-ELR2834 ABX-ELR2828 ABX-ELR2835
	Vasca inox forata Perforated stainless steel bowl Cuve perforée en acier inox Gelochte Edelstahlwanne
	GN4x1/1 - 100(h) mm
	180 €

Solo per modello ABX-CL2770 For ABX-CL2770 model only

ABX-A580
Portacoperchi inox Stainless steel lid holder Porte-couvercle en acier inox Edelstahl-Deckelhalter
115 €

ABX-A590
Portacoltelli Knives holder Porte-couteaux Messerhalter
70 €

ABX-A600
Scorrevole portapiatti con tagliere polietilene Sliding plate holder with polyethylene chopping board Porte-plat coulissant avec planche en polyéthylène Gleitplattenhalter mit Polyethylen-Schneidebrett
170 €

Optional

Mensole in legno per unione

CONNECTION WOODEN SHELF - ÉTAGÈRES EN BOIS POUR RACCORDS - VERBINDUNGSREGALE AUS HOLZ

MLUN



ANUN

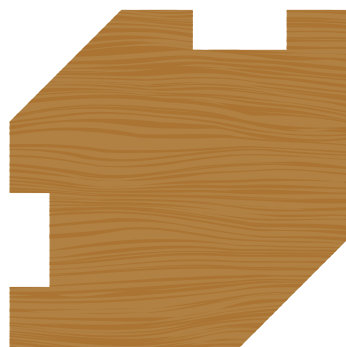

MLUNW



ANUNW



PER MODELLI / FOR MODEL

ABX-CLR2782			ABX-CL2778
ABX-CLR2784	ABX-ELR2825	ABX-ELC2828	ABX-CL2778
ABX-CLR2786	ABX-ELR2826	ABX-ELC2832	ABX-CL2778
ABX-CLR2787	ABX-ELR2827	ABX-ELC284	ABX-CL2778
ABX-CLR2788			ABX-CL2778

	ABX-MLUN	ABX-MLUNW	ABX-ANUN	ABX-ANUNW
	68 x 70 cm		88 x 88 cm	
	170 €		210 €	

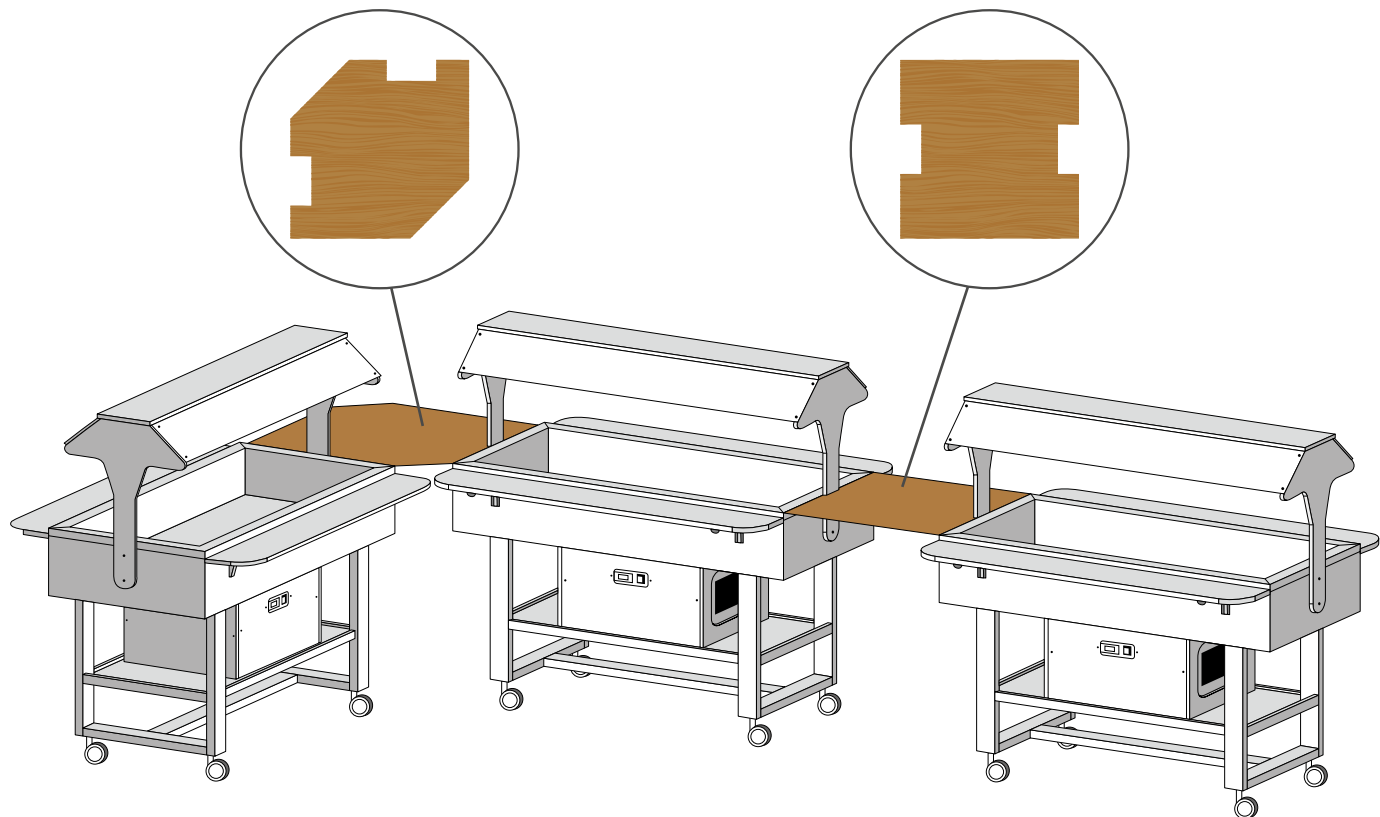
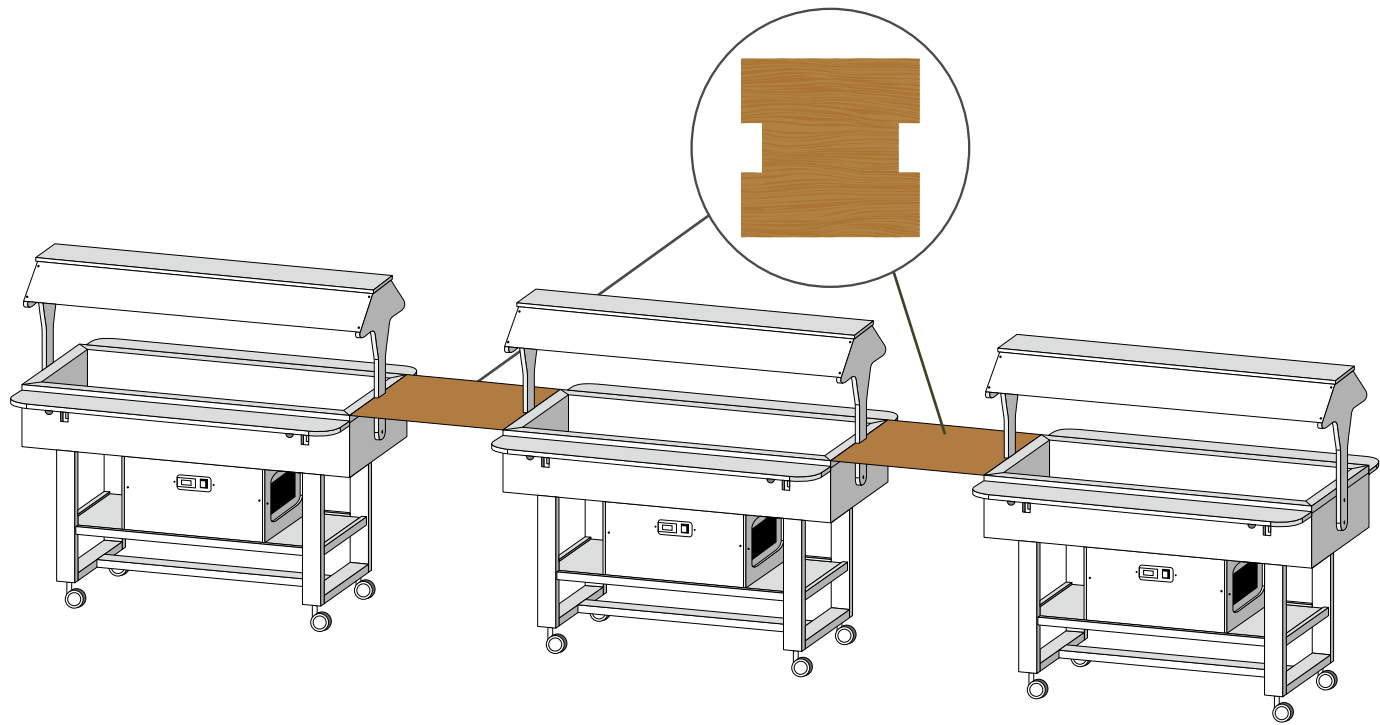



**Carrelli, vasche e distributori
in acciaio inox**



ABX-GVRI211
ABX-GVRI311
ABX-GVRI411
ABX-GVRI311F
ABX-GVRI411F







IT Vasche refrigerate da incasso in acciaio inox AISI 304. Struttura in acciaio inox AISI 304 - spessore isolamenti 50 mm - refrigerazione statica - gruppo incorporato nel vano inferiore - controllo temperatura elettronico con termostato digitale - sbrinamento automatico - evaporazione dell'acqua di condensa automatica.

EN Stainless steel AISI 304 refrigerated bowls. Stainless steel AISI 304 structure - 50 mm insulation thickness - static refrigeration - built-in control unit in the lower compartment - electronic temperature control with digital thermostat - automatic defrosting - automatic evaporation of condensation water.

FR Cuves réfrigérées en acier inox AISI 304 Structure en acier inox AISI 304 - épaisseur d'isolation de 50 mm - réfrigération statique - unité incorporée dans le compartiment inférieur - régulation électronique de température avec thermostat digital - dégivrage automatique - évaporation automatique de l'eau de condensation.

DE Kühlwannen aus Edelstahl AISI 304. Struktur aus Edelstahl AISI 304 - 50 mm Isolierstärke - statische Kühlung - Einbaueinheit im unteren Fach - elektronische Temperaturregelung mit digitalem Thermostat - automatische Abtaugung - automatische Kondensatverdampfung.

	ABX-GVRI211	ABX-GVRI311	ABX-GVRI411	ABX-GVRI311F	ABX-GVRI411F
	340 W				
 1 Ph	220/240V 50HZ				
	+2°C +8°C			-5°C +5°C	
 N.	2 x GN1/1 - 150(h) mm	3 x GN1/1 - 150(h) mm	4 x GN1/1 - 150(h) mm	3 x GN1/1 - 150(h) mm	4 x GN1/1 - 150(h) mm
	1.565 €	1.675 €	1.780 €	2.090 €	2.280 €

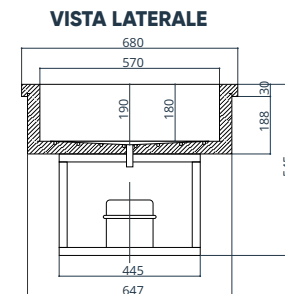
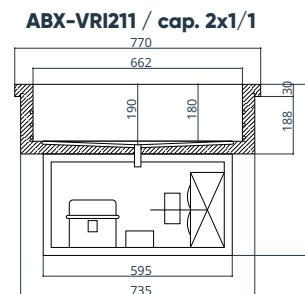
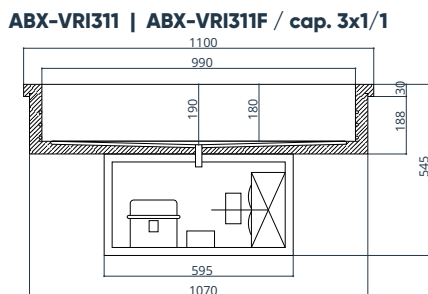
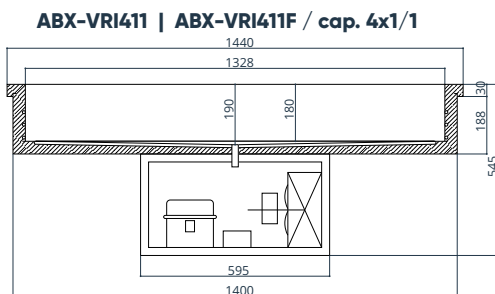

Vasche refrigerate in acciaio inox AISI 304 ad incasso
 Recessed stainless steel AISI 304 refrigerated bowls

ABX-VBC211

ABX-VBC311

ABX-VBC411



ABX-CLR311	ABX-CF411
GRIGLIA FORATA 3x1/1 S/S PERFORATED CONTAINER 3x1/1 GN	VASCA INOX FORATA 4x1/1GN S/S PERFORATED CONTAINER
160 €	180 €

- IT** Vasche termiche da incasso a bagnomaria in acciaio inox AISI 304. Vasca dotata di scarico acqua - controllo temperatura elettronico con termostato digitale.
- EN** Stainless steel AISI 304 heated Bain-marie bowls. Bowl with water drain - electronic temperature control with digital thermostat.
- FR** Cuves bain-marie en acier inox AISI 304. Cuve équipée de vidange d'eau - régulation électronique de la température avec thermostat digital.
- DE** Bain-Marie Heizwannen aus Edelstahl AISI 304. Wanne mit Wasserablauf - elektronische Temperaturregelung mit digitalem Thermostat.



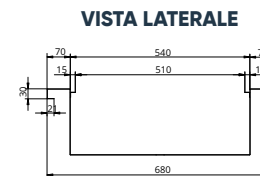
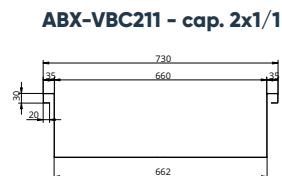
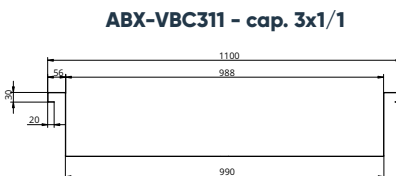
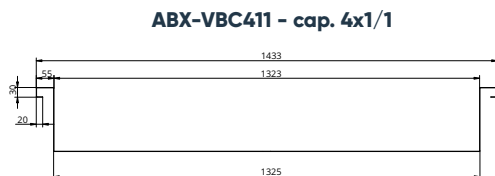



i	ABX-VBC211	ABX-VBC311	ABX-VBC411
⚡	2000 W		
🔌 1 Ph	220/240V 50HZ		
🌡️	+30°C +90°C		
N.	2 x GN1/1 - 150(h) mm	3 x GN1/1 - 150(h) mm	4 x GN1/1 - 150(h) mm
	730 €	810 €	910 €









ABX-CAR2779



- IT Carrello refrigerato in acciaio inox. Struttura in acciaio inox AISI 304 - refrigerazione statica - maniglia direzionale - ruote multidirezionali ø 125 mm. Bacinelle escluse - le temperature di lavoro indicate sono da considerarsi con coperchi posizionati.
- EN Stainless steel refrigerated trolley. Stainless steel AISI 304 structure - static refrigeration - directional handle - multidirectional wheels ø 125 mm. Containers not included - the operating temperatures listed are to be considered with lids on.
- FR Chariot réfrigéré en acier inox. Structure en acier inox AISI 304 - réfrigération statique - poignée directionnelle - roues multidirectionnelles Ø 125 mm. Bacs non compris - les températures de travail indiquées sont à considérer avec couvercles en place.
- DE Kühlwagen aus Edelstahl. Struktur Edelstahl AISI 304 - statische Kühlung - Lenkgriff - Mehrwegräder ø 125 mm. Behälter nicht enthalten - die angegebenen Arbeitstemperaturen sind bei aufgesetzten Deckeln zu verstehen.

	ABX-CAR2779	
	250 W	
 1 Ph	230V/1N/ 50HZ	
	R600a	
	+2°C +10°C	
	3 x GN1/1 - 150(h) mm	
	124 x 72 x 94(h) cm	
	2.780 €	

	ABX-CAR2780	ABX-CAR2780BT
	250 W	
 1 Ph	230V/1N/ 50HZ	
	R600a	
	+2°C +10°C	-5°C +5°C
	3 x GN1/1 - 150(h) mm	
	124 x 72 x 126(h) cm	
	3.160 €	3.470 €

ABX-CAR2780 ABX-CAR2780BT









Carrelli refrigerati in acciaio inox AISI 304
Stainless steel AISI 304 refrigerated trolleys

ABX-CT1760C



CON CUPOLA SEMICIRCOLARE / WITH SEMICIRCULAR DOME

- IT** Carrelli termici a bagnomaria. Struttura in acciaio inox AISI 304 - vasca a doppia parete provvista di rubinetto di scarico posto sul fondo - termostato regolabile - maniglia direzionale - paracolpi - ruote multidirezionali ø 125 mm. Bacinelle escluse - le temperature di lavoro indicate sono da considerarsi con coperchi posizionati.
- EN** Bain-marie heated trolleys. Stainless steel AISI 304 structure - double walled bowl with drain valve fitted at the bottom - adjustable thermostat - directional handle - shock absorber - multidirectional wheels ø 125 mm. Containers not included - the operating temperatures listed are to be considered with lids on.
- FR** Chariots chauffantes bain-marie. Structure en acier inox AISI 304 - cuve à double paroi équipée d'un robinet de vidange en bas - thermostat réglable - poignée directionnelle - butoirs - roues multidirectionnelles ø 125 mm. Bacs non compris - les températures de travail indiquées sont à considérer avec couvercles en place.
- DE** Bain-Marie Heizwagen Struktur aus Edelstahl AISI 304 - Doppelwandige Wanne mit einem Ablaufhahn im Unterteil - einstellbarer Thermostat - Lenkergriff - Stoßschutz - Mehrwegräder ø 125 mm. Behälter nicht enthalten - die angegebenen Arbeitstemperaturen sind bei aufgesetzten Deckeln zu verstehen.

	ABX-CT1760C
	2000 W
 1 Ph	230V/ 50-60 HZ
	+30° +90°C
	117 x 67 x 114(h) cm 3 x GN1/1 - 200(h) mm
	cm
	1.625 €

ABX-CT1758TD

ABX-CT1760TD









IT Carrelli termici a bagnomaria con temperature differenziate in acciaio inox AISI 304. Struttura in acciaio inox AISI 304 - vasca a doppia parete provvista di rubinetto di scarico posto sul fondo - termostato regolabile - maniglia direzionale - paracolpi - ruote multidirezionali \varnothing 125 mm. Bacinelle escluse - le temperature di lavoro indicate sono da considerarsi con coperchi posizionati.

EN Stainless steel AISI 304 Bain-marie heated trolleys with separate temperatures. Stainless steel AISI 304 structure - double walled bowl with drain valve fitted at the bottom - adjustable thermostat - directional handle - shock absorber - multidirectional wheels \varnothing 125 mm. Containers not included - the operating temperatures listed are to be considered with lids on.

FR Chariots chauffantes bain-marie à températures différenciées en acier inox AISI 304. Structure en acier inox AISI 304 - cuve à double paroi équipée d'un robinet de vidange en bas - thermostat réglable - poignée directionnelle - butoirs - roues multidirectionnelles \varnothing 125 mm. Bacs non compris - les températures de travail indiquées sont à considérer avec couvercles en place.

DE Bain-Marie Heizwagen mit unterschiedlichen Temperaturen aus Edelstahl AISI 304. Struktur aus Edelstahl AISI 304 - Doppelwandige Wanne ausgestattet mit einem unten angebrachten Ablaufventil - einstellbarer Thermostat - Lenkergriff - Stoßschutz - Mehrwegräder \varnothing 125 mm. Behälter nicht enthalten - die angegebenen Arbeitstemperaturen sind bei aufgesetzten Deckeln zu verstehen.

	ABX-CT1758TD	ABX-CT1760TD
	2000 W	3000 W
 1 Ph	230V/ 50-60 HZ	
	+30° +90°C	
 N.	2 x GN1/1 - 150(h) mm	3 x GN1/1 - 150(h) mm
 cm	84 x 65 x 85(h) cm	117 x 67 x 85(h) cm
	1.105 €	1.380 €

OPTIONAL



ABX-CT1765 ABX-CT1770



ABX-CT1765







ABX-CT1770

IT Carrelli termici a bagnomaria armadiati. Struttura in acciaio inox AISI 304 vano superiore in doppia parete coibentata - coperchi apribili a compasso fino a 180° per formare un piano di appoggio - provvisti di rubinetto di scarico posto sul fondo - 2 ruote fisse e 2 multidirezionali ø 140 mm. Bacinelle escluse - le temperature di lavoro indicate sono da considerarsi con coperchi posizionati.

EN Bain-marie heated trolleys on counters. Structure in AISI 304 stainless steel - insulated double-walled upper compartment - lids that can be opened up to 180° to form a support surface. Equipped with a drain valve on the bottom - 2 fixed wheels and 2 multidirectional wheels ø 140 mm. Containers not included - the operating temperatures listed are to be considered with lids on.

FR Chariots chauffants bain-marie sur meublé fermé. Structure en acier inox AISI 304 - compartiment supérieur en double paroi isolée - couvercles pouvant s'ouvrir jusqu'à 180° pour former une surface d'appui - 2 roues fixes et 2 roues multidirectionnelles ø 140 mm, équipées d'un robinet de vidange placé en bas. Bacs non compris - les températures de travail indiquées sont à considérer avec couvercles en place.

DE Bain-Marie Heizwagen mit Schrankelement. Struktur aus Edelstahl AISI 304 - oberes Fach mit isoliertem Doppelwand - Deckel bis zu 180° öffnungsfähig, um eine Auflagefläche zu bilden, ausgestattet mit einem unten angebrachten Ablaufventil - 2 feste Räder und 2 Mehrwegräder ø 140 mm. Behälter nicht enthalten - die angegebenen Arbeitstemperaturen sind bei aufgesetzten Deckeln zu verstehen.

	ABX-CT1765	ABX-CT1770
		
	2000 W	
 1 Ph	230V/ 50-60 HZ	
	+30° +90°C	
 N.	2 x GN1/1 - 200(h) mm	3 x GN1/1 - 200(h) mm
 cm	96 x 68 x 102(h) cm	130 x 68 x 102(h) cm
	2.680 €	2.965 €





ABX-CT1766

ABX-CT1771



ABX-CT1771

- IT** Carrelli termici a bagnomaria armadiati. Struttura in acciaio inox AISI 304 - vano superiore in doppia parete coibentata - provvisti di rubinetto di scarico posto sul fondo - 2 ruote fisse e 2 multidirezionali ø 140 mm. Bacinelle escluse.
- EN** Bain-marie heated trolleys on counters. Structure in AISI 304 stainless steel - insulated double-walled upper compartment - equipped with a drain valve on the bottom - 2 fixed wheels and 2 multidirectional wheels ø 140 mm. Containers not included.
- FR** Chariots chauffantes bain-marie sur meublé fermé. Structure en acier inox AISI 304 - compartiment supérieur en double paroi isolée - 2 roues fixes et 2 roues multidirectionnelles ø 140 mm, équipées d'un robinet de vidange placé en bas. Bacs non compris.
- DE** Bain-Marie Heizwagen mit Schrankelement. Struktur aus Edelstahl AISI 304 - oberes Fach mit isoliertem Doppelwand - ausgestattet mit einem unten angebrachten Ablaufventil - 2 feste Räder und 2 Mehrwegräder ø 140 mm. Behälter nicht enthalten.

	ABX-CT1766	ABX-CT1771
	2000 W	
	230V/ 50-60 HZ	
	+30° +90°C	
	2 x GN1/1 - 200(h) mm	3 x GN1/1 - 200(h) mm
	96 x 68 x 92(h) cm	130 x 68 x 92(h) cm
	2.135 €	2.425 €

OPTIONAL



ABX-CT1765TD ABX-CT1770TD



ABX-CT1765TD







IT Carrelli termici a bagnomaria armadiati con temperatura differenziata. Struttura in acciaio inox AISI 304 - vano superiore in doppia parete coibentata - coperchi apribili a compasso fino a 180° per formare un piano di appoggio - provvisti di rubinetto di scarico posto sul fondo - 2 ruote fisse e 2 multidirezionali ø 140 mm. Bacinelle escluse - le temperature di lavoro indicate sono da considerarsi con coperchi posizionati.

EN Bain-marie heated trolleys on counters with differentiated temperature. Structure in AISI 304 stainless steel - insulated double-walled upper compartment - lids that can be opened up to 180° to form a support surface. Equipped with a drain valve on the bottom - 2 fixed wheels and 2 multidirectional wheels ø 140 mm. Containers not included - the operating temperatures listed are to be considered with lids on.

FR Chariots bain-marie chauffés à température différenciée. Structure en acier inox AISI 304 - compartiment supérieur en double paroi isolée - couvercles pouvant s'ouvrir jusqu'à 180° pour former une surface d'appui - 2 roues fixes et 2 roues multidirectionnelles ø 140 mm, équipées d'un robinet de vidange placé en bas. Bacs non compris - les températures de travail indiquées sont à considérer avec couvercles en place.

DE Bain-Marie Heizwagen mit Schrankelement mit unterschiedlichen Temperaturen. Struktur aus Edelstahl AISI 304 - oberes Fach in isolierter Doppelwand - Deckel bis zu 180° öffnungsfähig, um eine Auflagefläche zu bilden, ausgestattet mit einem unten angebrachten Ablaufventil - 2 feste Räder und 2 Mehrwegräder ø 140 mm. Behälter nicht enthalten - die angegebenen Arbeitstemperaturen sind bei aufgesetzten Deckeln zu verstehen.

	CT 1765TD	ABX-CT1770TD
	2000 W	3000 W
 1 Ph	230V/ 50-60 HZ	
	+30° +90°C	
	2 x GN1/1 - 150(h) mm	3 x GN1/1 - 150(h) mm
 cm	96 x 68 x 102(h) cm	130 x 68 x 102(h) cm
	2.850 €	3.310 €







ABX-CT1766TD

ABX-CT1771TD



ABX-CT1771TD

- IT** Carrelli termici a bagnomaria armadiati con temperatura differenziata. Struttura in acciaio inox AISI 304 - vano superiore in doppia parete coibentata - provvisti di rubinetto di scarico posto sul fondo - 2 ruote fisse e 2 multidirezionali \varnothing 140 mm. Bacinelle escluse.
- EN** Bain-marie heated trolleys on counters with differentiated temperature. Structure in AISI 304 stainless steel - insulated double-walled upper compartment - Equipped with a drain valve on the bottom - 2 fixed wheels and 2 multidirectional wheels \varnothing 140 mm. Containers not included.
- FR** Bain-marie heated trolleys on counters with differentiated temperature. Structure in AISI 304 stainless steel - insulated double-walled upper compartment - équipée d'un robinet de vidange en bas - 2 roues fixes et 2 roues multidirectionnelles \varnothing 140 mm. Bacs non compris.
- DE** Bain-Marie Heizwagen mit Schrankelement mit unterschiedlichen Temperaturen. Struktur aus Edelstahl AISI 304 - oberes Fach in isolierter Doppelwand - ausgestattet mit einem unten angebrachten Ablaufventil - 2 feste Räder und 2 Mehrwegräder \varnothing 140 mm. Behälter nicht enthalten.

	ABX-CT1766TD	ABX-CT1771TD
	2000 W	3000 W
 1 Ph	230V/ 50-60 HZ	
	+30° +90°C	
	2 x GN1/1 - 150(h) mm	3 x GN1/1 - 150(h) mm
	96 x 68 x 92(h) cm	130 x 68 x 92(h) cm
	2.365 €	2.770 €

OPTIONAL



81

ABX-CS1751
ABX-CS1753
ABX-CS1755









FUORI PRODUZIONE
OUT OF PRODUCTION

IT Carrelli termici scalda tegamini/biberon. Struttura in acciaio inox AISI 304 - vasca a doppia parete provvista di rubinetto di scarico posto sul fondo - termostato regolabile - maniglia direzionale - ruote multidirezionali \varnothing 125 mm. Le temperature di lavoro indicate sono da considerarsi con coperchi posizionati.

EN Heated trolleys for small pans and baby bottles heating. Stainless steel AISI 304 structure - double walled bowl with drain valve fitted at the bottom - adjustable thermostat - directional handle - multidirectional wheels \varnothing 125 mm. The operating temperatures listed are to be considered with lids on.

FR Chariots chauffants pour réchauffer petit récipients ou biberon. Structure en acier inox AISI 304 - cuve à double paroi équipée d'un robinet de vidange en bas - thermostat réglable - poignée directionnelle - roues multidirectionnelles \varnothing 125 mm. Les températures de travail indiquées sont à considérer avec couvercles en place.

DE Heizwagen für Pfannen- und Babyflaschenerwärmung. Struktur aus Edelstahl AISI 304 - Doppelwandige Wanne ausgestattet mit einem unten angebrachten Ablaufventil - einstellbarer Thermostat - Lenkergriff - Mehrwegräder \varnothing 125 mm. Die angegebenen Arbeitstemperaturen sind bei aufgesetzten Deckeln zu verstehen.

A BAGNOMARIA / BAIN MARIE			
	ABX-CS1751	ABX-CS1753	ABX-CS1755
	2000 W		
 1 Ph	230V/ 50-60 HZ		
	+30° +90°C		
 cm	30 x 50 cm	51 x 62 cm	51 x 96 cm
 cm	56 x 65 x 85(h) cm	84 x 65 x 85(h) cm	117 x 65 x 85(h) cm
	-	-	-



ABX-CT1756
ABX-CT1758
ABX-CT1760
ABX-CT1762

ABX-CTS1757
ABX-CTS1759
ABX-CTS1761



IT Carrelli termici. Struttura in acciaio inox AISI 304 - vasca a doppia parete - termostato regolabile - maniglia direzionale - ruote multidirezionali ø 125 mm. Bacinelle escluse - le temperature di lavoro indicate sono da considerarsi con coperchi posizionati.

EN Heated trolleys. Stainless steel AISI 304 structure - double walled bowl - adjustable thermostat - directional handle - multidirectional wheels ø 125 mm. Containers not included - the operating temperatures listed are to be considered with lids on.

FR Chariots chauffants. Structure en acier inox AISI 304 - cuve à double paroi - thermostat réglable - poignée directionnelle - roues multidirectionnelles ø 125 mm. Bacs non compris - les températures de travail indiquées sont à considérer avec couvercles en place.

DE Heizwagen. Struktur aus Edelstahl AISI 304 - Doppelwandige Wanne - einstellbarer Thermostat - Lenkergriff - Mehrwegräder ø 125 mm. Behälter nicht enthalten - die angegebenen Arbeitstemperaturen sind bei aufgesetzten Deckeln zu verstehen.

Carrelli termici in acciaio inox AISI 304
 Stainless steel AISI 304 heated trolley

	A BAGNOMARIA / BAIN MARIE				CON RESISTENZA A SECCO / WITH DRY HEATING ELEMENT		
	ABX-CT1756	ABX-CT1756	ABX-CT1760	ABX-CT1762	ABX-CTS1757	ABX-CTS1759	ABX-CTS1761
	2000 W				1000 W	2000 W	
 1 Ph	230V/ 50-60 HZ						
	+30° +90°C						
	1 x GN1/1 - 200(h) mm	2 x GN1/1 - 200(h) mm	3 x GN1/1 - 200(h) mm	4 x GN1/1 - 200(h) mm	1 x GN1/1 - 200(h) mm	2 x GN1/1 - 200(h) mm	3 x GN1/1 - 200(h) mm
	56 x 65 x 85(h) cm	84 x 65 x 85(h) cm	117 x 65 x 85(h) cm	148 x 65 x 85(h) cm	56 x 65 x 85(h) cm	84 x 65 x 85(h) cm	117 x 65 x 85(h) cm
	950 €	1.070 €	1.180 €	1.385 €	850 €	1.000 €	1.235 €

ABX-DCM1699 ABX-DCM1701



ABX-DCM1699

ABX-DC1704 ABX-DC1703



ABX-DC1703





**FUORI PRODUZIONE
OUT OF PRODUCTION**





IT Distributori per prime colazioni. Struttura interamente in acciaio inox AISI 304 18/10 - vasca doppia parete - recipienti in acciaio inox AISI 304 18/10 da L 15 cad. complete di coperchio - rubinetti in plastica facilmente rimovibili - termostato regolabile - disponibili nella versione con mobiletto di sostegno in acciaio inox AISI 304 con anta battente - ripiano intermedio - ruote multidirezionali da \varnothing 95 mm, oppure nella versione da appoggio.

EN Breakfast dispensers. Structure entirely in stainless steel AISI 304 18/10 - double-walled bowl - containers in stainless steel AISI 304 18/10 of 15 L each, with lid - easily removable plastic taps - adjustable thermostat - available in the version with support unit in stainless steel AISI 304 with hinged door - intermediate shelf - \varnothing 95 mm multidirectional wheels, or in the countertop version.

FR Distributeurs pour le petit déjeuner. Structure entièrement en acier inox AISI 304 18/10 - cuve à double paroi - cuves en acier inox AISI 304 18/10 de 15 L chacune avec couvercle - robinets en plastique facilement démontables - thermostat réglable - disponible dans la version avec armoire en acier inox AISI 304 avec porte battante - étagère intermédiaire - roues multidirectionnelles \varnothing 95 mm ou en version de table.

DE Frühstücksspender. Gehäuse vollständig aus Edelstahl AISI 304 18/10 - doppelwandige Wanne - Behälter aus Edelstahl AISI 304 18/10 je 15 L mit Deckel - leicht abnehmbare Kunststoffhähne - einstellbarer Thermostat - erhältlich in der Ausführung mit Stützschränk aus Edelstahl AISI 304 mit Flügeltür - Zwischenboden - \varnothing 95 mm Mehrwegräder, oder als Tisch Version.

	ABX-DCM1699	ABX-DCM1701
	2000 W	
 1 Ph	230V/ 50-60 HZ	
	+30° +90°C	
	2 recipienti da 15 L 2 tanks 15 L	3 recipienti da 15 L 3 tanks 15 L
	75 x 41 x 135(h) cm	106 x 41 x 135(h) cm

	ABX-DC1704	ABX-DC1703
	2000 W	
 1 Ph	230V/ 50-60 HZ	
	+30° +90°C	
	2 recipienti da 15 L 2 tanks 15 L	3 recipienti da 15 L 3 tanks 15 L
	75 x 41 x 71(h) cm	106 x 41 x 71(h) cm

Carrelli termici Heated Trolleys

	ABX-A700
Mod.	ABX-CT1770 ABX-CT1771 ABX-CT1770TD ABX-CT1771TD
	Vano inferiore riscaldato Heated lower compartment Compartment inferieur chauffé Beheiztes Unterfach
	215 €

	ABX-A650
Mod.	ABX-CT1765 ABX-CT1766 ABX-CT1766TD ABX-CT1765TD
	Vano inferiore riscaldato Heated lower compartment Compartment inferieur chauffé Beheiztes Unterfach
	215 €



Optional



Elementi riscaldanti e vetrine neutre

ABX-BM1780

ABX-BM1782

ABX-BM1784

ABX-BM1786



ABX-BM1784

IT Tavole calde a bagnomaria. Struttura in acciaio inox AISI 304 - parete coibentata - rubinetto di scarico - termostato regolabile. Le bacinelle sono escluse.

EN Bain-marie heated tables. Stainless steel AISI 304 structure - insulated wall - drain valve- adjustable thermostat. Containers not included.

FR Tables chaudes avec bain-marie . Structure en acier inox AISI 304 - paroi isolée - robinet de vidange - thermostat réglable. Les bacs ne sont pas compris.

DE Bain-Marie Heitzische. Struktur aus Edelstahl AISI 304 - isolierte Wand - Ablaufventil - einstellbarer Thermostat. Behälter nicht enthalten.

	ABX-BM1780	ABX-BM1782	ABX-BM1784	ABX-BM1786
	2000 W			
 1 Ph	230V/ 50-60 HZ			
	+30° +90°C			
	1 x GN1/1 200(h) mm	2 x GN1/1 200(h) mm	3 x GN1/1 200(h) mm	4 x GN1/1 200(h) mm
	49 x 60 x 32(h) cm	78 x 60 x 32(h) cm	110 x 60 x 32(h) cm	144 x 60 x 32(h) cm
	770 €	905 €	980 €	1.120 €

ABX-BMS1781

ABX-BMS1783

ABX-BMS1785



ABX-BMS1785

IT Tavole calde con resistenza a secco (senza acqua). Struttura in acciaio inox AISI 304 - parete coibentata- termostato regolabile. Le bacinelle sono escluse.

EN Heated tables with dry heating element (without water). Stainless steel AISI 304 structure - insulated wall - adjustable thermostat. Containers not included.

FR Heated tables with dry heating element (without water). Stainless steel AISI 304 structure - insulated wall - adjustable thermostat. Containers not included.

DE Heitzische mit Trockenheizstab (ohne Wasser). Struktur aus Edelstahl AISI 304 - isolierte Wand - einstellbarer Thermostat. Behälter nicht enthalten.

	ABX-BMS1781	ABX-BMS1783	ABX-BMS1785
	1000 W		
 1 Ph	230V/ 50-60 HZ		
	+30° +90°C		
	1 x GN1/1 - 200(h) mm	2 x GN1/1 - 200(h) mm	3 x GN1/1 - 200(h) mm
	49 x 60 x 32(h) cm	78 x 60 x 32(h) cm	110 x 60 x 32(h) cm
	620 €	795 €	985 €

Tavole calde
Heated tables

ABX-BM11 ABX-BM21 ABX-BM31



ABX-BM11

ABX-BMV11 ABX-BMV21 ABX-BMV31



ABX-BMV11

IT Tavole calde a bagnomaria. Struttura in acciaio inox - termostato regolabile. Le bacinelle sono escluse.

EN Bain-marie heated tables. Stainless steel structure - adjustable thermostat. Containers not included.

FR Tables chaudes avec bain-marie . Structure en acier inox - thermostat réglable. Les bacs ne sont pas compris.

DE Bain-Marie Heitzische. Edelstahlstruktur - einstellbarer Thermostat. Behälter nicht enthalten.

IT Tavole calde a bagnomaria. Struttura in acciaio inox - rubinetto di scarico - temperature vasche differenziate - termostato regolabile. Le bacinelle sono escluse.

EN Bain-marie heated tables. Stainless steel structure - drain valve - differentiated bowl temperatures - adjustable thermostat. Containers not included.

FR Tables chaudes avec bain-marie . Structure en acier inox - robinet de vidange - différentes températures des cuves - thermostat réglable. Les bacs ne sont pas compris.

DE Bain-Marie Heitzische. Edelstahlstruktur - Ablaufventil - unterschiedliche Temperaturen - einstellbarer Thermostat. Behälter nicht enthalten.

	ABX-BM11	ABX-BM21	ABX-BM31
	1200 W	1200 + 1200 W	1000 + 1000 +1000 W
 1 Ph	230V/50-60 HZ		
	+30° +90°C		
	1 x GN1/1 - 150(h) mm	2 x GN1/1 - 150(h) mm	3 x GN1/1 - 150(h) mm
	54 x 33 x 22(h) cm	66 x 54 x 22(h) cm	99 x 54 x 22(h) cm
	390 €	570 €	760 €

	ABX-BMV11	ABX-BMV21	ABX-BMV31
	1200 W	1200 + 1200 W	1000 + 1000 +1000 W
 1 Ph	230V/50-60 HZ		
	+30° +90°C		
	1 x GN1/1 - 150(h) mm	2 x GN1/1 - 150(h) mm	3 x GN1/1 - 150(h)mm
	54 x 33 x 22(h) cm	66 x 54 x 22(h) cm	99 x 54 x 22(h) cm
	435 €	650 €	885 €

ABX-BM7700



ABX-BMP7720



- IT Tavola calda a bagnomaria. Struttura in acciaio inox - bacinella esclusa
- EN Bain-marie heated table. Stainless steel structure - containers not included
- FR Table chaude avec bain-marie . Structure en acier inox - bacs pas compris.
- DE Bain-Marie Heiztisch. Edelstahlstruktur - Behälter nicht enthalten

- IT Tavola calda a bagnomaria. Struttura in acciaio inox - modello compreso di 2 pentole da 8 L.
- EN Bain-marie heated table. Stainless steel structure - with 2 pans of 8 L.
- FR Table chaude avec bain-marie . Structure en acier inox - modèle équipé de 2 marmites de 8 L.
- DE Bain-Marie Heiztisch. Struktur aus Edelstahl - Modell mit 2 Kesseln 8 L je.

Tavole calde Heated tables

	ABX-BM7700
	1200 W
 1 Ph	230V/ 50-60 HZ
	+30° +90°C
 N.	1 x GN1/1 - 150(h) mm
 cm	57 x 37 x 22(h) cm
	200 €

	ABX-BMP7720
	1200 W
 1 Ph	230V/ 50-60 HZ
	+30° +90°C
	2 pentole 2 pots
 cm	57 x 37 x 28(h) cm
	290 €

ABX-PC4750
ABX-PC4754
ABX-PC6040





ABX-PC4752
ABX-PC5050
ABX-PC8060



ABX-PC4754

- IT Piani caldi in acciaio inox. Struttura in acciaio inox AISI 304 - termostato regolabile
- EN Hot plates in stainless steel. Stainless steel AISI 304 structure - adjustable thermostat.
- FR Hot plates in stainless steel. Stainless steel AISI 304 structure - adjustable thermostat.
- DE Heiße Edelstahlplatten. Struktur aus Edelstahl AISI 304 - einstellbarer Thermostat.

	ABX-PC4750	ABX-PC4752	ABX-PC4754
	250 W	450 W	600 W
 1 Ph	230V/ 50-60 HZ		
	+30° +90°C		
	50 x 35 x 6(h) cm	90 x 45 x 6(h) cm	100 x 50 x 6(h) cm
	200 €	270 €	325 €





	ABX-PC5050	ABX-PC6040	ABX-PC8060
	600 W		1000 W
 1 Ph	230V/50-60 HZ		
	+30° +90°C		
	50 x 50 x 6(h) cm	60 x 40 x 6(h) cm	80 x 60 x 6(h) cm
	260 €	270 €	405 €

ABX-PVC4760 **ABX-PVC4763**
ABX-PVC4765



ABX-PVC4760

- IT Piani caldi con piano in vetro temperato. Struttura in acciaio inox AISI 304 - termostato regolabile.
- EN Hot plates with tempered glass top. Stainless steel AISI 304 structure - adjustable thermostat.
- FR Plaques chauffantes avec plan en verre trempé. Structure en acier inox AISI 304 - thermostat réglable.
- DE Heiße Platten mit gehärteter Glasoberfläche. Struktur aus Edelstahl AISI 304 - einstellbarer Thermostat.

	ABX-PVC4760	ABX-PVC4763	ABX-PVC4765
	600 W		1000 W
 1 Ph	230V/50-60 HZ		
	+30° +90°C		
	50 x 50 x 7(h) cm	60 x 40 x 7(h) cm	81 x 61 x 7(h) cm
	400 €	385 €	470 €

ABX-PCC4710 ABX-PCC4730





ABX-PCC4710



ABX-PCC4730

- IT Piani caldi con cupola in plexiglass. Struttura in acciaio inox AISI 304 - termostato regolabile
- EN Hot plates with Plexiglas dome. Stainless steel AISI 304 structure - adjustable thermostat.
- FR Plaques chauffantes avec clochette en plexiglas. Structure en acier inox AISI 304 - thermostat réglable.
- DE Heiße Platten mit Plexiglashaube. Struktur aus Edelstahl AISI 304 einstellbarer Thermostat

	ABX- PCC4710	ABX- PCC4730
	450 W	600 W
 1 Ph	230V/ 50-60 HZ	230V/ 50-60 HZ
	+30° +90°C	
 cm	90 x 45 x 20(h) cm	100 x 50 x 30(h) cm
	540 €	610 €





Piani caldi
Hot plates

ABX-PCI4711 ABX-PCI4712 ABX-PCI4713



ABX-PCI4713

- IT Lampade a infrarossi con piano caldo in acciaio inox. Struttura in acciaio inox - termostato regolabile - copertura in policarbonato fumè.
- EN Infrared lamps with stainless steel heated plate. Stainless steel structure - adjustable thermostat - smoky grey polycarbonate lid.
- FR Lampes infrarouges avec plaque chaude en acier inox. Structure en acier inox - thermostat réglable - couvercle en polycarbonate fumé.
- DE Infrarot-Lampen mit Edelstahlwärmplatte. Struktur aus Edelstahl AISI 304 - einstellbarer Thermostat - dunkle Polycarbonatabdeckung.

	ABX- PCI4711	ABX- PCI4712	ABX- PCI4713
	250 +250 W	450 +500 W	600 +750 W
 1 Ph	230V/ 50-60 HZ		
	+30° +90°C		
	1 lampada 1 lamp	2 lampade 2 lamps	3 lampade 3 lamps
 cm	45 x 64 x 80(h) cm	85 x 64 x 80(h) cm	127 x 68 x 80(h) cm
	490 €	740 €	950 €

Lampade a raggi infrarossi
Infrared lamps

ABX-PI4714
ABX-PI4715
ABX-PI4716



ABX-PI4716



ABX-PI4715

IT Telaio con lampade a infrarossi.

EN Frame with infrared lamps.

FR Corps avec lampes infrarouges.

DE Rahmen mit Infrarotlampen.

ABX-PIA4714
ABX-PIA4715
ABX-PIA4716



ABX-PIA4716







ABX-PIA4715





IT Telaio con lampade a infrarossi da appendere.

EN Frame with hanging infrared lamps.

FR Corps avec lampes infrarouges suspendues.

DE Rahmen mit hängenden Infrarotlampen.

	ABX-PI4714	ABX-PI4715	ABX-PI4716
	250 W	500 W	750 W
 1 Ph	230V/ 50-60 HZ		
	+30° +90°C		
	1 lampada 1 lamp	2 lampade 2 lamps	3 lampade 3 lamps
	45 x 55 x 70(h) cm	85 x 55 x 70(h) cm	127 x 55 x 70(h) cm
	312 €	470 €	600 €

	ABX-PIA4714	ABX-PIA4715	ABX-PIA4716
	250 W	500 W	750 W
 1 Ph	230V/ 50-60 HZ		
	+30° +90°C		
	1 lampada 1 lamp	2 lampade 2 lamps	3 lampade 3 lamps
	45 x 68 x 25(h) cm	85 x 68 x 25(h) cm	128 x 68 x 25(h) cm
	245 €	390 €	500 €

ABX-PCI4717 ABX-PCI4718 ABX-PCI4718D



- IT Lampade a infrarossi con piano caldo in acciaio inox, in diversi modelli. Struttura in acciaio inox e termostato regolabile.
- EN Infrared lamps with stainless steel hot plate, in different models. Stainless steel structure and adjustable thermostat.
- FR Lampes infrarouges avec plaque chauffante en acier inox, en différents modèles. Structure en acier inox et thermostat réglable.
- DE Infrarotlampen mit Heizplatte aus Edelstahl, in verschiedenen Ausführungen. Edelstahlstruktur und einstellbarer Thermostat.

	ABX-PCI4717	ABX-PCI4718	ABX-PCI4718D
	250 + 250 + 250 W	250 + 250 W	250 + 250 + 250 W
	230V/ 50-60 HZ		
	+30° +90°C		
	2 lampade 2 lamps	1 lampada 1 lamp	2 lampade 2 lamps
	60 x 40 x 68(h) cm	58 x 33 x 68(h) cm	
	600 €	455 €	580 €

ABX-BI4719 ABX-BI4719D



- IT Lampade a infrarossi con contenitore Gastronorm GN1/1. Struttura in acciaio inox.
- EN Infrared lamps with Gastronorm GN1/1 container. Stainless steel structure
- FR Lampes infrarouges avec récipient Gastronorm GN1/1. Structure en acier inox.
- DE Infrarotlampen mit Gastronorm-Behälter GN1/1. Edelstahlstruktur

**OPTIONAL
ABX-A516**

Vasca riscaldata
Heated bowl
Cuve chauffée
Beheizte Wanne

105 €

	ABX-BI4719	ABX-BI4719D
	250 W	
	230V/ 50-60 HZ	
	+30° +90°C	
	1 lampada 1 lamp	2 lampade 2 lamps
	60 x 33 x 68(h) cm	
	515 €	535 €

Lampade a raggi infrarossi
Infrared lamps

ABX-VBR4751
ABX-VBR4781

ABX-VBR4752
ABX-VBR4782

ABX-VBR4753
ABX-VBR4783



ABX-VBR4751



ABX-VBR4752



ABX-VBR4753

IT Vetrine riscaldate. Struttura in acciaio inox AISI 304 - fianchi e antine sui due fronti in plexiglass trasparente - termostato regolabile - dispositivo di umidificazione.

EN Heated display cases. Structure in stainless steel AISI 304 - Plexiglas sides and doors on both sides - adjustable thermostat - humidification device.

FR Vitrines chauffées. Structure en acier inox AISI 304 - côtés et portes des deux côtés en plexiglas transparent - thermostat réglable - dispositif d'humidification.

DE Beheizte Vitrinen. Struktur aus Edelstahl AISI 304 - Seiten und Türen auf beiden Seiten aus transparentem Plexiglas - einstellbarer Thermostat - Befeuchtungsvorrichtung.

OPTIONAL
PRI50 - 250 W
ABX-VBR4751 | ABX-VBR4752 | ABX-VBR4753 | ABX-VBR4756

Piano intermedio riscaldato
Heated intermediate shelf
Étagère intermédiaire chauffée
Beheiztes Zwischenfach

185 €

OPTIONAL
PRI85 - 400 W
ABX-VBR4781 | ABX-VBR4782 | ABX-VBR4783 | ABX-VBR4786

Piano intermedio riscaldato
Heated intermediate shelf
Étagère intermédiaire chauffée
Beheiztes Zwischenfach

230 €

	ABX-VBR4751	ABX-VBR4781	ABX-VBR4752	ABX-VBR4782	ABX-VBR4753	ABX-VBR4783
	250 W	400 W	250 W	400 W	400 W	
	230V/ 50-60 HZ					
	+30° +90°C					
	1		2		3	
	50 x 35 x 25(h) cm	85 x 35 x 25(h) cm	50 x 35 x 40(h) cm	85 x 35 x 40(h) cm	50 x 35 x 54(h) cm	85 x 35 x 54(h) cm
	420 €	500 €	565 €	680 €	690 €	840 €

ABX-VBR4756 ABX-VBR4786









IT Vetrine riscaldate. Struttura in acciaio inox AISI 304- fianchi e antine sui due fronti in plexiglass trasparente - termostato regolabile - dispositivo di umidificazione.

EN Heated display cases. Structure in stainless steel AISI 304 - Plexiglas sides and doors on both sides - adjustable thermostat - humidification device.

FR Vitrines chauffées. Structure en acier inox AISI 304 - côtés et portes des deux côtés en plexiglas transparent - thermostat réglable - dispositif d'humidification.

DE Beheizte Vitrinen. Struktur aus Edelstahl AISI 304 - Seiten und Türen auf beiden Seiten aus transparentem Plexiglas - einstellbarer Thermostat - Befeuchtungsvorrichtung.

	ABX-VBR4756	ABX-VBR4786
	250 W	400 W
	230V/ 50-60 HZ	
	+30° +90°C	
	2	
	50 x 35 x 40(h) cm	85 x 35 x 40(h) cm
	570 €	690 €

Vetrine riscaldanti
Heated display cases

ABX-VBN4756 ABX-VBN4786



IT Vetrine neutre. Struttura in acciaio inox AISI 304 - fianchi e antine sui due fronti in plexiglass trasparente.

EN Neutral display cases. Structure in stainless steel AISI 304 - clear Plexiglas sides and doors on both sides .

FR Vitrines neutres. Structure en acier inox AISI 304 - côtés et portes des deux côtés en plexiglas transparent.

DE Neutrale Vitrinen. Struktur aus Edelstahl AISI 304 - Seiten und Türen auf beiden Seiten aus transparentem Plexiglas.

	ABX-VBN4756	ABX-VBN4786
	2	
	50 x 35 x 40(h) cm	85 x 35 x 40(h) cm
	390 €	495 €

Vetrine neutre
Neutral display

ABX-VBN4751 **ABX-VBN4781**
ABX-VBN4752 **ABX-VBN4782**
ABX-VBN4753 **ABX-VBN4783**



VBN 4751

- IT** Vetrine neutre. Struttura in acciaio inox AISI 304 - fianchi e antine sui due fronti in plexiglass trasparente .
- EN** Neutral display cases. Structure in stainless steel AISI 304 - clear Plexiglas sides and doors on both sides.
- FR** Vitrines neutres. Structure en acier inox AISI 304 - côtés et portes des deux côtés en plexiglas transparent.
- DE** Neutrale Vitrinen. Struktur aus Edelstahl AISI 304 - Seiten und Türen auf beiden Seiten aus transparentem Plexiglas.

ABX-VBE50



ABX-VBE85



- IT** Vetrina porta brioches e croissant. Struttura unica completamente in plexiglass con antine apribili sui due lati.
- EN** Brioche and croissants display case. Single structure completely in Plexiglas with openable doors on both sides.
- FR** Vitrine pour brioches et croissants. Structure unique entièrement en plexiglas avec portes qui peuvent être ouvertes des deux côtés.
- DE** Vitrine für Croissants und Hörnchen. Struktur komplett aus Plexiglas mit zweiseitig aufklappbaren Türen.

	ABX-VBE50	ABX-VBE85
	1	
	50 x 35 x 18(h) cm	85 x 35 x 18(h) cm
	170 €	230 €

	ABX-VBN4751	ABX-VBN4781	ABX-VBN4752	ABX-VBN4782	ABX-VBN4753	ABX-VBN4783
	1		2		3	
	50 x 35 x 25(h) cm	85 x 35 x 25(h) cm	50 x 35 x 36(h) cm	85 x 35 x 36(h) cm	50 x 35 x 50(h) cm	85 x 35 x 50(h) cm
	240 €	320 €	385 €	490 €	510 €	645 €

ABX-VL4748 ABX-VL4749

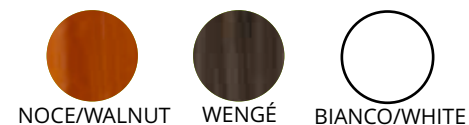

ABX-VL4748W



ABX-VL4749



ABX-VL4748B

IT Vetrina porta brioches e croissant. Piano in legno - disponibile nei colori noce, wengé e bianco. Cupola in plexiglass semitrasparente con antine apribili sui 2 lati.

EN Brioches and croissants display case. Wooden top - available in walnut, wengé and white colour. Semi-transparent Plexiglas dome with openable doors on 2 sides.

FR Vitrine pour brioches et croissants. Plan en bois - disponible en noyer, wengé et blanc. Clochette en plexiglas semi-transparent avec portes qui peuvent être ouvertes des deux côtés.

DE Vitrine für Croissants und Hörnchen. Holzplatte - erhältlich in Nussbaum, Wenge und Weiß. Halbtransparente Plexiglashaube zweiseitig aufklappbare Türen.

i	ABX-VL4748 noce/walnut	ABX-VL4748W wengé	ABX-VL4748B bianco/white	ABX-VL4749 noce/walnut	ABX-VL4749W wengé	ABX-VL4749B bianco/white
N.	1					
↗ cm	50 x 35 x 21(h) cm			85 x 35 x 21(h) cm		
	210 €		220 €		250 €	265 €

ABX-VPH100 ABX-VPH160

ABX-VPH120



ABX-MS1860RF2 ABX-MS1866RF2

ABX-MS1862RF2



IT Vetrine riscaldate con griglie - doppio vetro - struttura in acciaio inox AISI 304 - fianchi e antine sui due fronti in plexiglass trasparente - termostato regolabile.

EN Heated display cases, with grids - double-glazed - structure in stainless steel AISI 304 - clear Plexiglas sides and doors on both sides - adjustable thermostat.

FR Vitrines chauffées, avec grilles - double vitrage - structure en acier inox AISI 304 - côtés et portes des deux faces en plexiglas transparent - thermostat réglable.

DE Beheizte Vitrinen, mit Gitter - Doppelglas - Struktur aus Edelstahl AISI 304 - Seiten und Türen auf beiden Seiten aus transparentem Plexiglas - einstellbarer Thermostat.

IT Mobiletto scaldapiatti. Struttura in acciaio inox AISI 304 - termostato regolabile - 1 ripiano intermedio coibentato - ruote multidirezionali ø 95 mm di cui 2 con freno.

EN Plate warmer cabinet. AISI 304 stainless steel structure - adjustable thermostat - 1 insulated intermediate shelf - multidirectional wheels ø 95 mm - 2 wheels with brake.

FR Armoire chauffe-plat. Structure en acier inox AISI 304 - thermostat réglable - 1 étagère intermédiaire isolée - roues multidirectionnelles de ø 95 mm - 2 roues avec frein.

DE Tellerwärmer Schrank. Struktur aus Edelstahl AISI 304 - einstellbarer Thermostat - 1 isolierte Zwischenablage - Mehrwegräder ø 95 mm - 2 mit Bremse.

	ABX-VPH100	ABX-VPH120	ABX-VPH160
	1100 W		
	230V/ 50-60 HZ		
	+30° +90°C		
	2 piani - 2 griglie 2 shelves - 2 grids		
	71 x 46 x 67(h) cm GRC100A 643x272 mm GRC100B 643x303 mm	71 x 58 x 67(h) cm GRC120A 643x374 mm GRC120B 643x402 mm	88 x 58 x 67(h) cm GRC160A 819x374 mm GRC160B 819x407 mm
	920 €	1.200 €	1.440 €

	ABX-MS1860RF2	ABX-MS1862RF2	ABX-MS 1860RF2
	800 W		
	230V/ 50-60 HZ		
	+30° +90°C		
	60 piatti / plates 1 porta/door	100 piatti / plates 2 porte/ doors	120 piatti / plates 2 porte/ doors
	39 x 42 x 95(h) cm	70 x 42 x 80(h) cm	70 x 42 x 95(h) cm
	1.125 €	1.230 €	1.400 €







ABX-RTR97L**ABX-RTR97L2****ABX-RTR137L**

IT Vetrine riscaldate, da banco con griglie - doppio vetro - struttura in acciaio inox AISI 304 - fianchi e antine sui due fronti in plexiglass trasparente - termostato regolabile.

EN Heated display cases, counter-top versions with grids - double-glazed - structure in stainless steel AISI 304 - clear Plexiglas sides and doors on both sides - adjustable thermostat.

FR Vitrines chauffées, de table avec grilles - double vitrage - structure en acier inox AISI 304 - côtés et portes des deux faces en plexiglas transparent - thermostat réglable.

DE Beheizte Vitrinen, Tischmodell mit Gitter - Doppelglas - Struktur aus Edelstahl AISI 304 - Seiten und Türen auf beiden Seiten aus transparentem Plexiglas - einstellbarer Thermostat.

	ABX-RTR97L	ABX-RTR97L2	ABX-RTR137L
	400 W		
 1 Ph	230V/ 50-60 HZ		
	+30° +90°C		
 N.	3 piani / shelves	4 piani tondi rotanti 4 rotating round shelves	3 piani / shelves
 cm	46 x 45 x 78,5(h) cm		64,5 x 45 x 78,5(h) cm
	930 €	1.035 €	1.065 €



Carrelli per la cucina

ABX-CA1450



ABX-CA1460



ABX-CA1470





IT Carrelli portavassoi. Struttura e guide in acciaio inox - paracolpi in gomma - ruote multidirezionali \varnothing 125 mm. Predisposti di serie per vassoi GN1/1 - 53x32,5 cm. Realizzabili su richiesta per qualsiasi misura di vassoio, da specificare al momento dell'ordine.

EN Tray trolleys - Stainless steel structure and slides - rubber shock absorbers - multidirectional wheels \varnothing 125 mm. Standard equipped for GN1/1 trays - 53x32,5 cm. Available on request for any tray size, to be mentioned when ordering.

FR Chariots porte plateaux. Structure et guides en acier inox - butoirs en caoutchouc - roues multidirectionnelles \varnothing 125 mm. Prêt en standard pour plateaux GN1/1 - 53x32,5 cm. Disponible sur demande pour toute taille de plateau, à préciser à la commande.

DE Tablettwagen - GN1/1. Struktur und Führungen aus Edelstahl - Gummistoßschutz - Mehrwegräder \varnothing 125 mm. Standardmäßig vorgesehen für Bleche GN1/1 - 53x32,5 cm. Erhältlich auf Anfrage für jede Blechgröße, bitte bei der Bestellung angeben.

	ABX-CA1450	ABX-CA1460	ABX-CA1470
	45 x 62 x 175(h) cm	81 x 62 x 175(h) cm	117 x 62 x 175(h) cm
	10 vassoi / trays	20 vassoi / trays	30 vassoi / trays
	395 €	605 €	825 €

ABX-CA1450P



ABX-CA1460P



ABX-CA1470P



PANNELLI
LATERALI
SIDE
PANELS



IT Carrelli portavassoi con pannelli laterali in perfix bianco, acciaio inox o wengé. Struttura e guide in acciaio inox - paracolpi in gomma - ruote multidirezionali \varnothing 125 mm. Predisposti di serie per vassoi GN1/1 - 53x32,5 cm. Realizzabili su richiesta per qualsiasi misura di vassoio e/o con pannello posteriore, da specificare al momento dell'ordine.

FR Chariots porte plateaux à panneaux latéraux en perfix blanc, acier inox ou wengé. Structure et guides en acier inox - butoirs en caoutchouc - roues multidirectionnelles \varnothing 125 mm. Prêt en standard pour plateaux GN1/1 - 53x32,5 cm. Disponible sur demande pour toute taille de plateau et / ou avec panneau arrière, à préciser à la commande.

EN Tray trolleys with side panels in white perfix, stainless steel or wengé. Stainless steel structure and slides - rubber shock absorbers - multidirectional wheels \varnothing 125 mm. Standard equipped for GN1/1 trays - 53x32,5 cm. Available on request for any tray size and/or with rear panel, to be mentioned when ordering.

DE Tablettwagen mit Seitenwänden in Weiß Perfix, Edelstahl oder Wenge. Struktur und Führungen aus Edelstahl - Gummistoßschutz - Mehrwegräder \varnothing 125 mm. Standardmäßig vorgesehen für Bleche GN1/1 - 53x32,5 cm. Erhältlich auf Anfrage für jede Blechgröße und / oder mit Rückwand, bitte bei der Bestellung angeben.

	ABX-CA1450P bianco-white	ABX-CA1450PI inox	ABX-CA1450PW wengé	ABX-CA1460P bianco-white	ABX-CA1460PI inox	ABX-CA1460PW wengé	ABX-CA1470P bianco-white	ABX-CA1470PI inox	ABX-CA1470PW wengé
	45 x 62 x 175(h) cm			81 x 62 x 175(h) cm			117 x 62 x 175(h) cm		
	10 vassoi / trays			20 vassoi / trays			30 vassoi / trays		
	460 €	530 €	530 €	660 €	815 €	725 €	875 €	1.010 €	1.010 €

ABX-CA1451R



ABX-CA1461R



ABX-CA1471R



PANNELLI
LATERALI
SIDE
PANELS



BIANCO/WHITE



INOX

IT Carrelli portavassoi rinforzati, disponibili anche con pannelli laterali in perfix bianco o in acciaio inox. Struttura tubolare in acciaio inox 25x25 cm - guide in acciaio inox di spessore 1,2 mm - paracolpi in gomma - ruote multidirezionali \varnothing 125 mm. Predisposti di serie per vassoi GN1/1 - 53x32,5 cm. Realizzabili su richiesta per qualsiasi misura di vassoio e/o con pannello posteriore, da specificare al momento dell'ordine.

EN Reinforced tray trolleys also available with side panels in white perfix or stainless steel. Stainless steel tubular structure 25x25 mm - stainless steel slides with 1,2 mm thickness - rubber shock absorbers - multidirectional wheels \varnothing 125 mm. Standard equipped for GN1/1 trays - 53x32,5 cm. Available on request for any tray size and/or with rear panel, to be mentioned when ordering.

FR Chariots à plateaux renforcés disponibles aussi avec panneaux latéraux en perfix blanc ou acier inox. Structure tubulaire en acier inox 25x25 cm - guides en acier inox épaisseur 1,2 mm - butoir en caoutchouc - roues multidirectionnelles \varnothing 125 mm. Prêt en standard pour plateaux GN1/1 - 53x32,5 cm. Disponible sur demande pour toute taille de plateau et / ou avec panneau arrière, à préciser à la commande.

DE Verstärkte Tablettwagen auch mit Seitenwänden aus weißem Perfix oder Edelstahl erhältlich. Struktur aus Edelstahl 25x25 mm - 1,2 mm dicke Edelstahlführungen - Gummistoßschutz - Mehrwegräder \varnothing 125 mm. Standardmäßig vorgesehen für Bleche GN1/1 - 53x32,5 cm. Erhältlich auf Anfrage für jede Blechgröße und / oder mit Rückwand, bitte bei der Bestellung angeben.

	ABX-CA1451R	ABX-CA1451RP bianco-white	ABX-CA1451RPI inox	ABX-CA1461R	ABX-CA1461RP bianco-white	ABX-CA1461RPI inox	ABX-CA1471R	ABX-CA1471RP bianco-white	ABX-CA1471RPI inox
	45 x 62 x 174(h) cm			81 x 62 x 174(h) cm			118 x 62 x 174(h) cm		
	10 vassoi / trays			20 vassoi / trays			30 vassoi / 30 trays		
	520 €	570 €	680 €	835 €	880 €	985 €	1.120 €	1.190 €	1.290 €

Carrelli portavassoi rinforzati GN1/1
GN1/1 tray trolleys - reinforced

OPTIONAL



ABX-CA1455



ABX-CA1465



ABX-CA1475



PANNELLI
LATERALI
SIDE
PANELS



IT Carrelli portavassoi universali con possibilità di avere pannelli laterali in perfix bianco o in acciaio inox. Struttura in acciaio inox - guide in filo di acciaio cromato - paracolpi in gomma - ruote multidirezionali \varnothing 125 mm. Bacinelle e teglie escluse.

FR Chariots à plateaux universels isponibles aussi avec panneaux latéraux en perfix blanc ou acier inox. Structure en acier inox - glissières en fil d'acier chromé - butoirs en caoutchouc - roues multidirectionnelles \varnothing 125 mm. Bacs et plaques pas compris.

EN Universal tray trolleys also available with side panels in white perfix or stainless steel. Stainless steel structure - chromed steel wire slides - rubber shock absorbers - multidirectional wheels \varnothing 125 mm. Containers and pans not included.

DE Universal-Tablett Wagen auch mit Seitenwänden aus weißem Perfix oder Edelstahl erhältlich. Struktur aus Edelstahl - verchromte Stahldrahtführungen - Gummistoßschutz - Mehrwegräder \varnothing 125 mm. Behältern und Bleche nicht enthalten.

	ABX-CA1455	ABX-CA1455P bianco-white	ABX-CA1455PI inox	ABX-CA1465	ABX-CA1465P bianco-white	ABX-CA1465PI inox	ABX-CA1475	ABX-CA1475P bianco-white	ABX-CA1475PI inox
	55 x 62 x 175(h) cm			95 x 62 x 175(h) cm			138 x 62 x 175(h) cm		
	10 vassoi / trays			20 vassoi / trays			30 vassoi / trays		
	385 €	460 €	595 €	600 €	670 €	805 €	805 €	880 €	1.015 €

ABX-CA1455V12

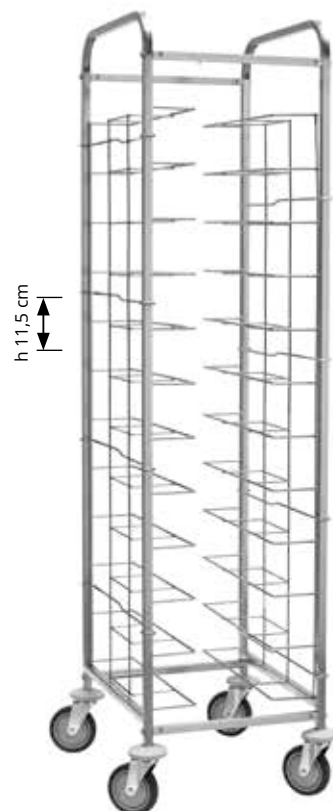

ABX-PT15

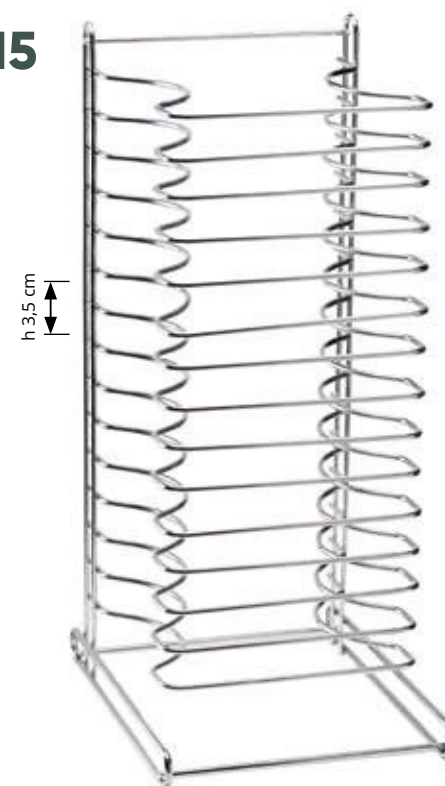

IT Carrelli portavassoi universali con possibilità di avere pannelli laterali in perex bianco o in acciaio inox. Struttura in acciaio inox - guide in filo di acciaio cromato - paracolpi in gomma - ruote multidirezionali \varnothing 125 mm.

EN Universal tray trolleys. Stainless steel structure - chromed steel wire slides - rubber shock absorbers - multidirectional wheels \varnothing 125 mm.

FR Chariots à plateaux universels. Structure en acier inox - glissières en fil d'acier chromé - butoirs en caoutchouc - roues multidirectionnelles \varnothing 125 mm.

DE Universal-Tablett Wagen. Struktur aus Edelstahl - verchromte Stahldrahtführungen - Gummistoßschutz - Mehrwegräder \varnothing 125 mm.

IT Portateglie da banco per teglie tonde da cm. 26 a 32. Confezione minima 4 pz.

EN Table-top tray holder for round trays size 26 to 32 cm. Minimum pack 4 pcs.

FR Porte-plateau de table pour plateaux ronds de 26 à 32 cm. Paquet minimum de 4 pièces.

DE Tisch-Tabletthalterung für runde Tablette von 26 bis 32 cm. Mindestmenge 4 Stück.

	ABX-CA1455V12
	52 x 62 x 185(h) cm
	12 vassoi / trays
	395 €

	ABX-PT15
	38 x 29 x 67(h) cm
	15 teglie / trays
	90 €

ABX-CA1476



ABX-CA1477



ABX-CA1478



ABX-CA1479



IT Carrelli portateglie GN. Struttura e guide in acciaio inox - paracolpi in gomma - ruote multidirezionali \varnothing 125 mm. Predisposti di serie per GN2/1. A richiesta possibilità di altre misure. Teglie escluse.

EN GN pans trolleys Stainless steel structure and slides - rubber shock absorbers - multidirectional wheels \varnothing 125 mm. Standard equipped for GN2/1. Other sizes available on request. Trays not included.

FR Chariots à plateaux GN. Structure et glissières en acier inox - butoirs en caoutchouc - roues multidirectionnelles \varnothing 125 mm. En standard pour GN2/1. Autres mesures disponibles sur demande. Plateaux pas compris.

DE GN-Blechwagen. Struktur und Führungen aus Edelstahl - Gummistoßschutz - Mehrwegräder \varnothing 125 mm. Serienmäßig ausgerüstet für GN2/1. Andere Größen sind auf Anfrage erhältlich. Bleche nicht enthalten.

	ABX-CA1476	ABX-CA1477	ABX-CA1478	ABX-CA1479
	64,5 x 72 x 182(h) cm	64,5 x 62 x 94(h) cm	44,5 x 62 x 94(h) cm	44,5 x 62 x 175(h) cm
	14 x GN2/1 - 28 x GN1/1	8 x GN2/1 - 16 x GN1/1	8 x GN1/1	14 x GN1/1
	530 €	570 €	500 €	470 €



ABX-CA1489R

ABX-CA1486R

ABX-CA1492R



ABX-AV4947 60 x 30 x 2(h) cm	ABX-AV4937 60 x 40 x 2(h) cm
Teglia Blurex - Blurex tray Plaque Blurex - Blurex Form	
	
23 €	
ABX-AV4950 60 x 30 x 2(h) cm	ABX-AV4940 60 x 40 x 2(h) cm
Teglia alluminata - Aluminized pan Pan aluminisé - Aluminisierte pan	
	
25 €	
ABX-AV4980 60 x 40 x 2(h) cm	
Teglia in alluminio - Aluminium tray Plateau en aluminium Aluminiumschale	
	
32 €	

IT Carrelli portateglie GN rinforzati. Struttura tubolare in acciaio inox 25x25 cm - guide in acciaio inox di spessore 1,2 mm - paracolpi in gomma - ruote multidirezionali ø 125 mm. Teglie escluse.

EN GN pans trolleys - reinforced Stainless steel tubular structure 25x25 mm - stainless steel slides with 1,2 mm thickness - rubber shock absorbers - multidirectional wheels ø 125 mm. Trays not included.

FR Chariots à plateaux GN renforcés. Structure tubulaire en acier inox 25x25 cm - glissières en acier inox épaisseur 1,2 mm - butoir en caoutchouc - roues multidirectionnelles ø 125 mm. Plateaux pas compris.

DE Verstärkte GN-Blechwagen. Edelstahlrohrstruktur 25x25 cm - 1,2 mm dicke Edelstahlführungen - Gummistoßschutz - Mehrwegräder ø 125 mm. Bleche nicht enthalten.

Carrelli portateglie rinforzati GN1/1 - GN2/1 - 60x40 cm
GN1/1 - GN2/1 - 60x40 cm pans trolleys - reinforced

	ABX-CA1489R	ABX-CA1486R	ABX-CA1492R
	45,5 x 62 x 177(h) cm	65,5 x 72 x 181(h) cm	53 x 72 x 181(h) cm
	14 x GN1/1	14 x GN2/1 - 28 x GN1/1	teglie / trays 60 x 40 cm
	620 €	665 €	600 €

ABX-CA1650 ABX-CA1656



ABX-CA1656

ABX-CA1655



ABX-CA1655

ABX-CA1482 ABX-CA1483



ABX-CA1482

ABX-CA1482T20 ABX-CA1493



ABX-CA1483

IT Carrelli portateglie 60x40 cm e porta bacinelle GN1/1 65(h) mm. Struttura in acciaio inox - guide in filo di acciaio cromato - paracolpi in gomma - ruote multidirezionali \varnothing 125 mm. Bacinelle e teglie escluse.

EN Tray trolleys 60x40 cm and trays GN1/1 65(h) mm. Stainless steel structure - chromed steel wire slides - rubber shock absorbers - multidirectional wheels \varnothing 125 mm. Containers and pans not included.

FR Chariots à plateaux 60x40 cm et pour bacs GN1/1 65(h) mm. Structure en acier inox - glissières en fil d'acier chromé - butoirs en caoutchouc - roues multidirectionnelles \varnothing 125 mm. Bacs et plaques pas compris.

DE Tablett Wagen 60x40 cm und Tablett GN1/165(h) mm. Struktur aus Edelstahl - verchromte Stahldrahtführungen - Gummistoßschutz - Mehrwegräder \varnothing 125 mm. Behältern und Bleche nicht enthalten.

IT Carrelli portateglie per pasticceria. Struttura e guide in acciaio inox - paracolpi in gomma - ruote multidirezionali \varnothing 125 mm. A richiesta altre misure disponibili. Teglie escluse.

EN Pastry tray trolleys Stainless steel structure and slides - rubber shock absorbers - multidirectional wheels \varnothing 125 mm. Other sizes available on request. Trays not included.

FR Chariots à plateaux pâtisserie. Structure et glissières en acier inox - butoirs en caoutchouc - roues multidirectionnelles \varnothing 125 mm. Autres mesures disponibles sur demande. Plateaux pas compris.

DE Konditorei-Blechwagen. Struktur und Führungen aus Edelstahl - Gummistoßschutz - Mehrwegräder \varnothing 125 mm. Andere Größen sind auf Anfrage erhältlich. Bleche nicht enthalten.

	ABX-CA1655	ABX-CA1656	ABX-CA1650
	67 x 46 x 117(h) cm	67 x 46 x 153(h) cm	51,5 x 67 x 175(h) cm
	GN1/1 65(h) mm 10 teglie / trays 60x40 cm	GN1/1 65(h) mm 15 teglie / trays 60x40 cm	GN1/1 65(h) mm 10 teglie/trays - 60x40 cm e vassoi / trays
	380 €	465 €	450 €

	ABX-CA1482	ABX-CA1482T20	ABX-CA1483	ABX-CA1493
	52 x 72 x 182(h) cm		52 x 72 x 94(h) cm	72 x 87 x 94(h) cm
	14 teglie / trays 60 x 40 cm	20 teglie / trays 60 x 40 cm	8 teglie / trays 60 x 40 cm	8 teglie / trays 80 x 60 cm 16 teglie / trays 60 x 40 cm
	495 €	610 €	530 €	625 €

ABX-CA1480



ABX-CA1480D

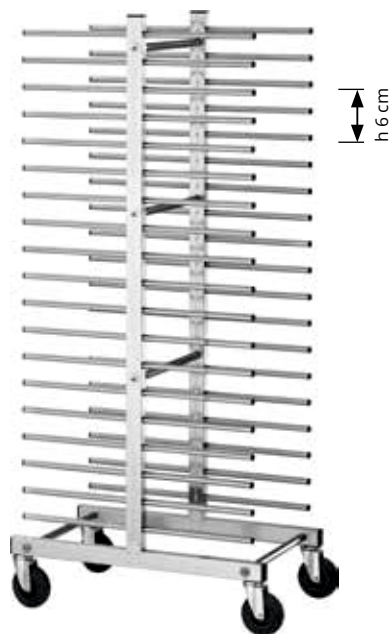

- IT** Carrelli portateglie universali. Struttura e guide in acciaio inox - paracolpi in gomma - ruote multidirezionali \varnothing 125 mm. Teglie escluse
- EN** Universal tray trolleys. Stainless steel structure and slides - rubber shock absorbers - multidirectional wheels \varnothing 125 mm. Trays not included.
- FR** Chariots à plateaux universels. Structure et glissières en acier inox - butoirs en caoutchouc - roues multidirectionnelles \varnothing 125 mm. Plateaux pas compris.
- DE** Universal-Blechwagen. Struktur und Führungen aus Edelstahl - Gummistoßschutz - Mehrwegräder \varnothing 125 mm. Bleche nicht enthalten.

	ABX-CA1480	ABX-CA1480D
	50 x 51 x 177(h) cm	50 x 81 x 177(h) cm
	20 teglie / trays	40 teglie / trays
	540 €	650 €

Optional

**FUORI PRODUZIONE
OUT OF PRODUCTION**

ABX-A510

Baciniere en ABS
ABS Flaschenhalter

ABX-A500

Bacinella portabottiglie
in acciaio inox
Stainless steel bottle tray
Porte-bouteilles en acier inox
Edelstahl Flaschenhalter

120 €



ABX-A512

Ruote con freno - Wheels with catch
Roues avec frein - Räder mit Bremse

ABX-CA1450 | ABX-CA1455 | ABX-CA1460 | ABX-CA1470 | ABX-CA1465 | ABX-CA1475
ABX-CA1477 | ABX-CA1476 | ABX-CA1478 | ABX-CA1479 | ABX-CA1480 | ABX-CA1480D
ABX-CA1482 | ABX-CA1482T20 | ABX-CA1483 | ABX-CA1493

10 € cad./each

ABX-A514

Ruote con freno - Wheels with catch
Roues avec frein - Räder mit Bremse

ABX-CA1451 | ABX-CA1461 | ABX-CA1471 | ABX-CA1489R | ABX-CA1486R | ABX-CA1492

13 € cad./each



ABX-A512

ABX-A514



Carrelli portapiatti e cestelli

ABX-CA1435
ABX-CA1436
ABX-CA1435G
ABX-CA1436G

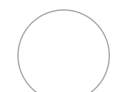

GRIGLIA
VERNICIATA
PAINTED
GRID



WARNING

Dimensioni imballo
Packing dimensions
35 x 90 x 50(h) cm



ABX-CA1435



GRIGLIA
CROMATA
CHROME
PLATED GRID

ABX-CA1437
ABX-CA1438
ABX-CA1437G
ABX-CA1438G



GRIGLIA
VERNICIATA
PAINTED
GRID



WARNING

Dimensioni imballo
Packing dimensions
35 x 165 x 50(h) cm

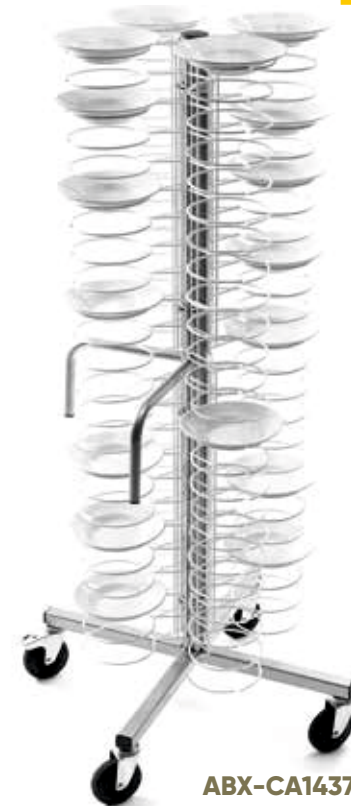

ABX-CA1437



GRIGLIA
CROMATA
CHROME
PLATED GRID

IT Colonna portapiatti da banco. Struttura in acciaio plastificato - griglie verniciate o cromate - piedini regolabili.

EN Countertop tiered plate holder stand. Plastic-coated steel structure - painted or chromed grids - adjustable feet.

FR Colonne porte-assiettes de table. Structure en acier plastifié - grilles peintes ou chromées - pieds réglables.

DE Tellerwagen, Tischmodell. Struktur aus kunststoffbeschichtetem Stahl - lackierte oder verchromte Gitter - verstellbare FüÙe.

IT Carrelli portapiatti. Struttura in acciaio plastificato - griglie verniciate o cromate - maniglie per conduzione carrello - ruote ø 125 mm di cui due con freno.

EN Plate trolleys. Plastic-coated steel structure - painted or chrome-plated grids - handles for trolley operation - ø 125 mm wheels, two of which with brakes.

FR Chariots à assiettes. Structure en acier plastifié - grilles peintes ou chromées - poignées pour l'entraînement du chariot - roues de ø 125 mm, dont deux avec freins.

DE Tellerwagen. Struktur aus kunststoffbeschichtetem Stahl - lackierte oder verchromte Gitter - Lenkergriff - Räder ø 125 mm, davon zwei mit Bremsen.

Portapiatti da banco
Table top plate rack

	ABX-CA1435 griglie verniciate painted grid	ABX-CA1436 griglie cromate chrome-plated grill	ABX-CA1435G griglie verniciate painted grid	ABX-CA1436G griglie cromate chrome-plated grill
	60 x 60 x 83(h) cm		70 x 70 x 83(h) cm	
	48 piatti / plates ø 18/23 cm		48 piatti / plates ø 25/31 cm	
	380 €	390 €	390 €	430 €

	ABX-CA1437 griglie verniciate painted grid	ABX-CA1438 griglie cromate chrome-plated grill	ABX-CA1437G griglie verniciate painted grid	ABX-CA1438G griglie cromate chrome-plated grill
	60 x 60 x 173(h) cm		70 x 70 x 173(h) cm	
	96 piatti / plates ø 18/23 cm		96 piatti / plates ø 25/31 cm	
	740 €	760 €	760 €	840 €



Confezionamento in kit per risparmio costi trasporto
Packing in set for saving transport charges
Emballage en kit pour sauver frais d'expédition
Verpackung in kit um Versandkosten zu sparen

ABX-CA1439P



Dimensioni imballo
Packing dimensions
40 x 165 x 68(h) cm
peso / weight 50 kg

WARNING

Confezionamento in kit per risparmio costi trasporto
Packing in set for saving transport charges
Emballage en kit pour sauver frais d'expédition
Verpackung in kit um Versandkosten zu sparen



ABX-CA1439 ABX-CA1440 ABX-CA1439G ABX-CA1440G



GRIGLIA
VERNICIATA
PAINTED
GRID



WARNING



GRIGLIA
CROMATA
CHROME
PLATED GRID

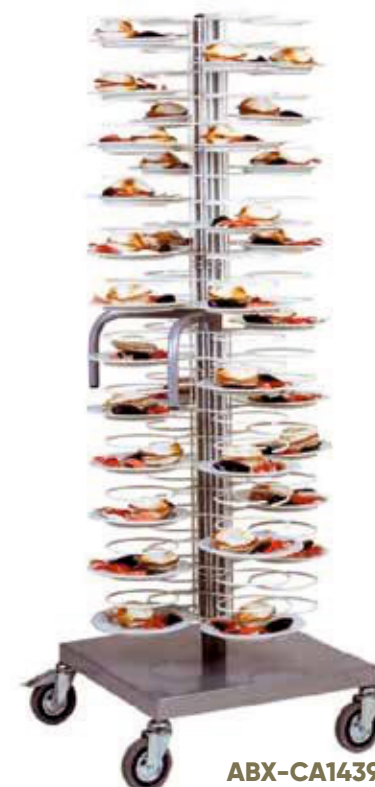

ABX-CA1439

IT Portapiatti da parete. Struttura in acciaio plastificato - griglie plastificate.

EN Wall plate holder. Plastic-coated steel structure - plastic-coated grids.

FR Porte-assiettes à mur. Structure en acier plastifié - grilles plastifiées.

DE Wandtellerhalter. Kunststoffbeschichtete Stahlstruktur - beschichtete Gitter.

IT Carrelli portapiatti. Struttura in acciaio plastificato con base in lamiera antipolvere - griglie verniciate o cromate - maniglie per conduzione carrello - ruote ø 125 mm di cui due con freno.

EN Plate trolleys. Plastic-coated steel structure with dust-proof lower shelf - painted or chrome-plated grids - handles for trolley operation - ø 125 mm wheels, two of which with brakes.

FR Chariots à assiettes. Structure en acier plastifié avec base en tôle anti-poussière - grilles peintes ou chromées - poignées pour l'entraînement du chariot - roues de ø 125 mm, dont deux avec freins.

DE Tellerwagen. Struktur aus kunststoffbeschichtetem Stahl mit staubdichtem Boden - lackierte oder verchromte Gitter - Lenkergriff - Räder ø 125 mm, davon zwei mit Bremsen.

	ABX-CA1439P
	42 x 20 x 90(h) cm
	12 piatti / plates ø 18/23 cm
	105 €

	ABX-CA1439P griglie verniciate painted grid	ABX-CA1440 griglie cromate chrome-plated grill	ABX-CA1439G griglie verniciate painted grid	ABX-CA1440G griglie cromate chrome-plated grill
	60 x 60 x 175(h) cm		70 x 70 x 175(h) cm	
	96 piatti / plates ø 18/23 cm		96 piatti / plates ø 25/31 cm	
	895 €	915 €	910 €	995 €

Optional

ABX-A410 (mod.CA 1439-1440)	ABX-A420 (mod.CA 1439G-1440G)
Copertura in PVC con 4 cerniere. PVC lid with 4 hinges. Couverture en PVC avec 4 charnières. PVC-Abdeckung mit 4 Scharnieren.	
300 €	350 €

ABX-A512 (mod.CP 1441-1441C - CA 631-656-659)
Ruote con freno Wheels with catch Roues avec frein Räder mit Bremse
10 € cad./each

ABX-A1001 (mod.CP ABX-CP1441 ABX-1441C)	ABX-A1002 (mod.CP ABX-CP1441 ABX-1441C)
Cestino piccolo Small basket Petit panier Klein Korb	Cestino grande Big basket Grand panier Gros Korb
12 €	28 €



ABX-CP1441 ABX-CP1441C



IT Carrelli per il trasporto piatti. Struttura in tubo di acciaio inox - ripiano portapiatti e pannellatura in lamiera di acciaio inox - ruote multidirezionali ø 125 mm.

EN Dish transport trolleys. Structure in stainless steel tube - stainless steel plate shelf and panelling - multidirectional wheels ø 125 mm.

FR Chariots pour transporter la vaisselle. Structure en tube d'acier inox - étagère et revêtement en tôle d'acier inox - roues multidirectionnelles ø 125 mm.

DE Geschirrwagen. Edelstahlrohrstruktur - Tellerablage und Verkleidung aus Edelstahlblech - Mehrwegräder ø 125 mm.

i	ABX-CP1441	ABX-CP1441C
cm	91 x 57 x 101(h) cm	
N.	1	2
	200 piatti / plates	
	565 €	725 €

ABX-CG1439A

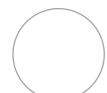

GRIGLIA
VERNICIATA
PAINTED
GRID



ABX-CA1439A ABX-CA1440A ABX-CA1439AG ABX-CA1440AG

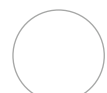

GRIGLIA
VERNICIATA
PAINTED
GRID



GRIGLIA
CROMATA
CHROME
PLATED GRID

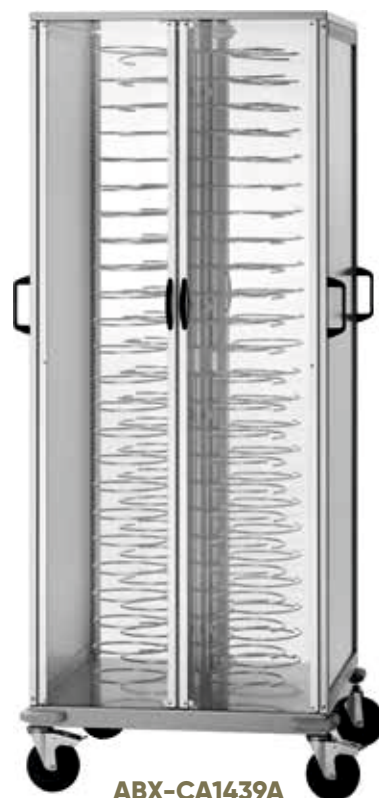

ABX-CA1439A

IT Carrelli portapiatti armadiati. Struttura portante in acciaio plastificato - telaio in alluminio anodizzato - pannellatura in perflex con 4 sportelli apribili in plexiglass - griglie verniciate o cromate - maniglie laterali per conduzione carrello - ruote multidirezionali ø 125 mm di cui due con freno.

EN Cabinet plate trolleys. Supporting structure in plastic-coated steel - anodized aluminium frame - perflex panelling with 4 openable Plexiglas doors - painted or chrome-plated grids - side handles for trolley operation - multidirectional wheels ø 125 mm, two of which with brakes.

FR Chariots porte-assiettes sur élément fermé. Structure portante en acier plastifié - corps en aluminium anodisé - panneaux en perflex avec 4 portes ouvrantes en plexiglas - grilles peintes ou chromées - poignées latérales pour le déplacement - roues multidirectionnelles ø 125 mm dont deux avec frein.

DE Tellerwagen mit Schrankelement. Tragstruktur aus kunststoffbeschichtetem Stahl - Rahmen aus eloxiertem Aluminium - Blenden in Perflex mit 4 Flügeltüren aus Plexiglas - lackierte oder verchromte Gitter - seitliche Lenkergriffe - Mehrwegräder ø 125 mm, zwei davon mit Bremsen.

	ABX-CG1439A griglie verniciate / painted grid
	75 x 78 x 170(h) cm
	10 griglie verniciate GN2/1 - 10 painted grids GN2/1
	2.080 €

	ABX-CA1439A griglie verniciate painted grid	ABX-CA1440A griglie cromate chrome-plated grill	ABX-CA1439AG griglie verniciate painted grid	ABX-CA1440AG griglie cromate chrome-plated grill
	75 x 78 x 183(h) cm			
	88 piatti / plates ø 18/23 cm	88 piatti / plates ø 18/23 cm	88 piatti / plates ø 25/31 cm	88 piatti / plates ø 25/31 cm
	1.825 €	1.890 €	1.835 €	1.940 €



ABX-CG1439AC

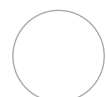

GRIGLIA
VERNICIATA
PAINTED
GRID



IT Carrelli portapiatti armadiati e riscaldati. Struttura portante in acciaio plastificato - termostato regolabile - telaio in alluminio anodizzato - pannellatura in PERFEX con n. 4 sportelli apribili in plexiglass - griglie verniciate o cromate maniglie laterali per conduzione carrello - ruote ø 125 mm di cui due con freno.

EN Heated cabinet plate trolleys. Supporting structure in plastic-coated steel - adjustable thermostat - anodized aluminium frame - perfex panelling with 4 openable Plexiglas doors - painted or chrome-plated grids - side handles for trolley operation - multidirectional wheels ø 125 mm, two of which with brakes.

FR Chariots porte-assiettes chauffantes sur élément fermé. Structure portante en acier plastifié - thermostat réglable - corps en aluminium anodisé - panneaux en PERFEX avec 4 portes ouvrables en plexiglas - grilles chromées - poignées latérales pour le déplacement- roues ø 125 mm, dont deux avec frein.

DE Beheizter Tellerwagen und mit Schrankelement. Tragstruktur aus Kunststoffbeschichtetem Stahl. Einstellbarer Thermostat Rahmen aus eloxiertem Aluminium. Blenden in Perfex mit 4 Flügeltüren aus Plexiglas. Verchromte Gitter Seitliche Lenkergriffe - Räder diam. 125 mm, zwei davon mit Bremsen.

ABX-CA1440AC ABX-CA1440ACG

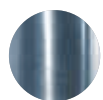

GRIGLIA
CROMATA
CHROME
PLATED GRID

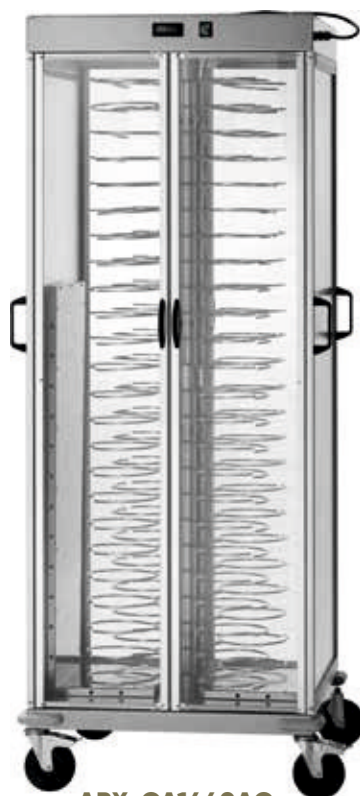

ABX-CA1440AC

	ABX-CG1439AC	
	800 + 800 W	
	230V/ 50-60 HZ	
	max 60°C	
	10 griglie verniciate GN2/1 / 10 painted grids GN2/1	
	75 x 78 x 177(h) cm	
	3.150 €	

	ABX-CA1440AC	ABX-CA1440ACG
	800 + 800 W	
	230V/ 50-60 HZ	
	max 60°C	
	88 piatti / plates ø 18/23 cm	88 piatti / plates ø 25/31 cm
	75 x 78 x 177(h) cm	
	2.830 €	2.880 €

Carrelli portapiatti armadiati riscaldati
Heated cabinet plate trolleys

ABX-CA1439R ABX-CA1439RG

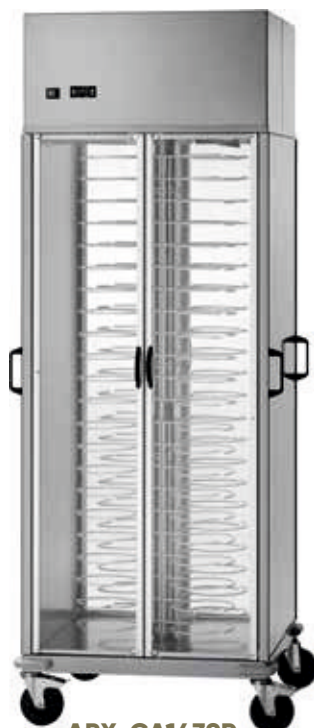

ABX-CA1439R

ABX-CG1439R









IT Carrelli portapiatti refrigerati. Struttura portante in acciaio plastificato - telaio in alluminio anodizzato - pannellatura in isomac spessore 25 mm con 4 sportelli apribili in plexiglass- griglie plastificate - maniglie laterali per conduzione carrello - ruote ø 125 mm di cui due con freno.

EN Refrigerated cabinet plate trolleys Supporting structure in plastic-coated steel - anodized aluminium frame - isomac panelling with 25 mm thickness and 4 openable Plexiglas doors - plastic coated grids - side handles for trolley operation - multidirectional wheels ø 125 mm, two of which with brakes.

FR Chariots porte-assiettes réfrigérées. Structure portante en acier plastifié - corps en aluminium anodisé - panneaux en isomac épaisseur 25 mm avec 4 portes ouvrantes en plexiglas - grilles plastifiées - poignées latérales pour le déplacement - roues ø 125 mm dont deux avec frein.

DE Gekühlte Tellerwagen. Tragstruktur aus kunststoffbeschichtetem Stahl - Rahmen aus eloxiertem Aluminium - 25 mm starke Isomac-Blenden mit 4 Flügeltüren aus Plexiglas - kunststoffbeschichtete Gitter - seitliche Lenkergriffe - Räder ø 125 mm, zwei davon mit Bremsen.

	ABX-CA1439R	ABX-CA1439RG	ABX-CG1439R
	460 W		
	230V/ 50-60 HZ		
	+8°C - +12 °C		
	R290		
	88 piatti / plates ø 18/23 cm	88 piatti / plates ø 25/28 x 213(h) cm	10 griglie x GN2/1 10 grills x GN2/1
			
	2.900 €	2.915 €	3.310 €

ABX-CA656 ABX-CA631



ABX-CA656

ABX-CA659

FUORI PRODUZIONE
OUT OF PRODUCTION



ABX-CA631

ABX-CA1399 ABX-CA1400 ABX-CA1401



ABX-CA1399

IT Carrelli per ritiro, distribuzione e stoccaggio vassoi, piatti, tazze, ecc. Telaio in acciaio inox - cesti asportabili in filo di acciaio plastificato - paracolpi - ruote multidirezionali ø 125 mm.

EN Trolleys for collecting, distributing and storing trays, plates, cups, etc. Stainless steel frame - removable baskets made of plastic-coated steel wire - shock absorbers - multidirectional wheels ø 125 mm.

FR Chariots de collecte, de distribution et de stockage de plateaux, assiettes, tasses, etc. Structure en acier inox - paniers amovibles en fil d'acier plastifié - butoirs - roues multidirectionnelles ø 125 mm.

DE Wagen zum Sammeln, Verteilen und Lagern von Tablets, Tellern, Tassen usw. Edelstahlrahmen - abnehmbare Körbe aus kunststoffbeschichtetem Stahldraht - Stoßschutz - Mehrwegräder ø 125 mm.

IT Carrello scolapiatti e bicchieri. Telaio in tubo di acciaio inox - ripiani con griglie in acciaio inox per piatti - vaschette scola bicchieri in acciaio inox - piano raccogliocce in acciaio inox - ruote multidirezionali ø 125 mm.

EN Plates and glasses drainer trolley. Stainless steel tubular frame - shelves with stainless steel grids for plates - stainless steel glass draining trays - stainless steel drip tray - multidirectional wheels ø 125 mm.

FR Chariot égouttoir assiettes et verres. Structure en tube d'acier inox - étagères avec grilles en acier inox pour assiettes - plateaux d'égouttage pour les verres en acier inox - cuve de récupération en acier inox - roues multidirectionnelles ø 125 mm.

DE Geschirr und Gläser Abtropfwagen. Edelstahlrohrrahmen - Stellflächen mit Edelstahlgittern für Teller - Abtropfschalen für Gläser aus Edelstahl - Tropfschale aus Edelstahl - Mehrwegräder ø 125 mm.

	ABX-CA656	ABX-CA631	ABX-CA659
	88 x 50 x 92(h) cm	75 x 65 x 92(h) cm	FUORI PRODUZIONE OUT OF PRODUCTION
	1 cesto / basket	1 cesto / basket	2 cesto / baskets
	100 piatti / plates ø23 cm	130 vassoi / trays 53x32,5 / 37x53cm	200 piatti / plates ø23 cm
	450 €	350 €	-

Carrelli portapiatti per trasporto e ritiro
Plates transport and collection trolleys

	ABX-CA1399	ABX-CA1400	ABX-CA1401
	110 x 62 x 134(h) cm		110 x 62 x 160(h) cm
	3 scolapiatti 3 plates drainers ø23 cm	1 scolabicchieri 1 glasses drainer 2 scolapiatti 2 plates drainers	4 scolapiatti 4 plates drainers
	830 €	960 €	1.025 €

Scolapiatti e bicchieri
Plates and glasses drainer

ABX-SPB1398



ABX-SP1397



IT Pensili scolapiatti e bicchieri da muro. Struttura in acciaio inox lucido 18/8.

EN Hanging plates and glasses drainer. Structure in 18/8 polished stainless steel.

FR Égouttoir mural pour assiettes et verres. Structure en acier inox poli 18/8.

DE Geschirr und Gläser Wandabtropfschränke. Struktur aus poliertem Edelstahl 18/8.

	ABX-SPB1398	ABX-SP1397
	80 x 26 x 37(h) cm ø23 cm	104 x 30 x 55(h) cm ø23 cm
	90 €	230 €

ABX-CP1442



IT Carrelli portacestelli per lavastoviglie. Struttura tubolare in acciaio inox 50x50 cm. Ruote multidirezionali ø 125 mm - cestelli non inclusi.

EN Dishwasher trolleys. Stainless steel tubular structure 50x50 cm. Multidirectional wheels ø 125 mm - baskets not included.

FR Chariots pour lave-vaisselle. Structure tubulaire en acier inox 50x50 cm. Roues multidirectionnelles ø 125 mm - paniers pas compris.

DE Spülmaschinenwagen. 50x50 cm Edelstahlrohrstruktur. Mehrwegräder ø 125 mm - Körbe nicht enthalten.

	ABX-CP1442
	65 x 65 x 170(h) cm
	345 €

Carrello portacestelli
Basket trolley

ABX-CP1447 ABX-CP1448



ABX-CP1448

ABX-CP1445 ABX-CP1446



ABX-CP1445

IT Carrelli portacestelli per lavastoviglie. Vasca in ABS - disponibile con o senza manico in acciaio inox - ruote multidirezionali \varnothing 125 mm - cestelli non inclusi.

EN Dishwasher basket trolleys. ABS base - available with or without stainless steel handle - multidirectional wheels \varnothing 125 mm - baskets not included.

FR Chariots porte-paniers pour lave-vaisselle. Fond en ABS - disponible avec ou sans poignée en acier inox - roues multidirectionnelles \varnothing 125 mm - paniers pas compris.

DE Korbwagen für Geschirrspülerkörbe. ABS-Boden - mit oder ohne Edelstahlgriff erhältlich - Mehrwegräder \varnothing 125 mm - Körbe nicht enthalten.

IT Carrelli portacestelli per lavastoviglie. Vasca in acciaio inox - disponibile con o senza manico in acciaio inox - ruote multidirezionali \varnothing 125 mm. Ceste non incluse.

EN Dishwasher basket trolleys. Stainless steel base - available with or without stainless steel handle - multidirectional wheels \varnothing 125 mm. Baskets not included.

FR Chariots porte-paniers pour lave-vaisselle. Fond en acier inox - disponible avec ou sans poignée en acier inox - roues multidirectionnelles \varnothing 125 mm. Paniers pas compris.

DE Korbwagen für Geschirrspülerkörbe. Edelstahl Boden - mit oder ohne Edelstahlgriff erhältlich - Mehrwegräder \varnothing 125 mm, Körbe nicht enthalten.

	ABX-CP1447 con manico - with handle	ABX-CP1448 senza manico - without handle
	53 x 56 x 92(h) cm	53 x 56 x 21(h) cm
	150 €	105 €

	ABX-CP1445 con manico - with handle	ABX-CP1446 senza manico - without handle
	52 x 58 x 96(h) cm	52 x 52 x 20(h) cm
	295 €	260 €

Carrello portacestelli
Basket trolley

ABX-CB1444 ABX-CB1443



ABX-CB1444

ABX-CB1449



- IT** Carrelli per impasti pizza con cassette da 60x40 cm - interamente in acciaio inox - disponibile con o senza manico in acciaio inox - ruote multidirezionali ø 125 mm.
- EN** Pizza dough trolleys with 60x40 cm containers - entirely made of stainless steel - available with or without stainless steel handle - multidirectional wheels ø 125 mm.
- FR** Chariots à pâte à pizza avec bacs de 60x40 cm - entièrement en acier inox - disponible avec ou sans poignée en acier inox - roues multidirectionnelles ø 125 mm.
- DE** Pizzateigwagen mit 60x40 cm Behälter - komplett aus Edelstahl - mit oder ohne Edelstahlgriff erhältlich - Mehrwegräder ø 125 mm.

- IT** Carrello portacassette per impasti pizza 60x40 cm - senza manico - vasca in ABS - ruote multidirezionali ø 125 mm.
- EN** Trolley for Pizza dough containers 60x40 cm - without handle - ABS base - multidirectional wheels ø 125 mm.
- FR** Chariot à bacs pour pâte à pizza 60x40 cm - sans poignée - fond en ABS - roues multidirectionnelles ø 125 mm.
- DE** Wagen für Pizzateigbehälter 60x40 cm - ohne Griff - ABS-Boden - Mehrwegräder ø 125 mm.

	ABX-CB1444 con manico - with handle	ABX-CB1443 senza manico - without handle
	72 x 42 x 96(h) cm	62 x 42 x 20(h) cm
	270 €	235 €

	ABX-CB1449
	62 x 42 x 16,5(h) cm
	80 €

Cestelli per lavastoviglie 50x50 cm



Dishwasher baskets 50x50 cm
Paniers pour lave-vaisselle 50x50 cm
Körbe für Geschirrspüler 50x50 cm

i	ABX-BVM	ABX-BV	ABX-B9	ABX-B16	ABX-B25	ABX-B36	ABX-B49	ABX-BP	ABX-BA
	base vuota h 90 mm col. grigio per posate	base vuota h 90 mm col. grigio universale	base 9 scomparti h 90 mm col. grigio (bicchiere diam. 140 mm)	base 16 scomparti h 90 mm col. grigio (bicchiere diam. 110 mm)	base 25 scomparti h 90 mm col. grigio (bicchiere diam. 80 mm)	base 36 scomparti h 90 mm col. grigio (bicchiere diam. 70 mm)	base 49 scomparti h 90 mm col. grigio (bicchiere diam. 60 mm)	base per piatti o vassoi h 90 mm col. grigio	base per vassoi aperto su un lato h 90 mm col. grigio
	23 €	23 €	25 €	26 €	28 €	29 €	32 €	24 €	21 €

i	ABX-RIAU	ABX-RIA9	ABX-RIA25	ABX-RIA36	ABX-RIA49	ABX-RIA16	ABX-CP8	ABX-COPCEST
	rialzo universale h 45 mm col. blu	rialzo 9 scomparti h 45 mm col. blu	rialzo 25 scomparti h 45 mm col. blu	rialzo 36 scomparti h 45 mm col. blu	rialzo 49 scomparti h 45 mm col. blu	rialzo 16 scomparti h 45 mm col. blu	cestellino inserto portaposate 8 scomparti	coperchio standard per cestelli
	12 €	13 €	13 €	15 €	14 €	13 €	15 €	17 €

DISPONIBILI ALTRI PRODOTTI NEL CATALOGO FIMAR
AVAILABLE OTHER PRODUCTS ON FIMAR CATALOGUE

Cestelli per lavastoviglie
Dishwasher baskets



Carrelli e articoli per il servizio in camera

ABX-CB980

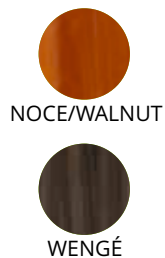

NOCE/WALNUT

WENGÉ



ABX-CB980

Esclusa cassetta
Boxes not included

ABX-CB970

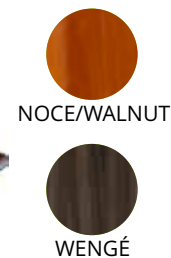

NOCE/WALNUT

WENGÉ

ABX-CB970W

Esclusa cassetta
Boxes not included

IT Carrelli per la colazione. Struttura portante in tubo di acciaio inox - ripiano con antine ribaltabili in nobilitato - disponibile nei colori noce o wengé - ripiano di servizio ruotabile sino a 90°, con possibilità di incastrare i carrelli uno dentro l'altro per ridurre al minimo l'ingombro. Ruote multidirezionali di cui 2 con freno.

EN Breakfast trolleys. Supporting structure in stainless steel tube - shelf with melamine folding doors - available in walnut or wengé colour - service shelf that can be rotated up to 90°, trolleys can be pushed one inside the other to reduce the overall dimensions considerably. Multidirectional wheels, 2 with brake.

FR Chariots pour le petit déjeuner. Structure portante en tube d'acier inox - plan de travail avec volets en mélaminé - disponible en noyer ou wengé - plan de service pivotant jusqu'à 90°, les chariots peuvent être rangés les uns dans les autres pour réduire l'encombrement au minimum. Roues multidirectionnelles, dont 2 avec frein.

DE Frühstückswagen. Tragstruktur aus Edelstahlrohr - Abstellfläche mit Klapptüren aus Melamin - erhältlich in den Farben Nussbaum oder Wenge - bis zu 90° drehbare Ablagefläche, Wagen ineinander stapelbar, um die Außenmaße höchst möglichst zu reduzieren. Mehrwegräder, davon 2 mit Bremse.

i	ABX-CB980 noce-walnut	ABX-CB980W wengé
↗ cm	Open ø 80 x 80(h) cm Closed 80 x 53 x 80(h) cm	
535 €		

i	ABX-CB970 noce-walnut	ABX-CB970W wengé
↗ cm	Open 80 x 53 x 80(h) cm Closed 35 x 53 x 80(h) cm	
535 €		

ABX-CST300



- IT** Casseta termica per scaldare piatti e prime colazioni. Contenitore interamente in acciaio inox - piano intermedio - termostato regolabile.
- EN** Heating box to warm plates and breakfasts. Container entirely in stainless steel - intermediate shelf - adjustable thermostat
- FR** Boîte thermique pour réchauffer les assiettes et les petits déjeuners. Corps entièrement en acier inox - étagère intermédiaire - thermostat réglable.
- DE** Wärmekiste zum Erwärmen von Teller und Frühstück. Kiste komplett aus Edelstahl - Zwischenboden - einstellbarer Thermostat.

	ABX-CST300
	250 W
	230V/ 50-60 HZ
	+30° +60°C
	39 x 37 x 46(h) cm - n.2 piatti /plates ø33 cm
	400 €

ABX-CPC600

Cassette termiche non incluse
Boxes not included



- IT** Carrello porta cassette termiche Mod. CTS300 con allacciamento elettrico. Struttura tubolare 25x25 cm in acciaio inox - guide per contenere n.6 cassette termiche. Ruote ø 125 mm di cui 2 con freno. Cassette non incluse.
- EN** Heating boxes trolley Mod. CTS300 with electrical connection. Tubular structure 25x25 cm in stainless steel - slides to store 6 heating boxes. Wheels ø 125 mm 2 of which with brake. Boxes not included.
- FR** Chariot à boîtes thermiques Mod. CTS300 avec connexion électrique. Structure en tube d'acier inox 25x25 cm - glissières pour contenir 6 boîtes thermiques. Roues ø 125 mm dont 2 avec frein. Boîte pas compris.
- DE** Wagen für Wärmekiste Mod. CTS300 mit elektrischem Anschluss. Rohrstruktur 25x25 cm aus Edelstahl - Führungen für 6 Wärmekisten. Räder ø 125 mm davon 2 mit Bremse. Wärmekisten nicht enthalten.

	ABX-CPC600
	230V/ 50-60 HZ
	155 x 61 x 132(h) cm - ø33 cm
	470 €



ABX-PV4062**ABX-PV4064****ABX-PV4055****ABX-PV4056**

IT Carrelli portavaligie e portabiti. Base in legno ricoperta da moquette colorata, disponibile nei colori rosso o blu - supporto asta in tubolare di acciaio ottonato o cromato da \varnothing 40 mm - bordo paracolpi perimetrale in gomma - ruote multidirezionali \varnothing 200 mm.

EN Luggage trolleys and clothes racks. Wooden base covered with coloured carpet, available in red or blue - rod support in brass-plated or chrome-plated steel tube \varnothing 40 mm - perimeter rubber shock absorber - multidirectional wheels \varnothing 200 mm.

FR Chariots à bagages et porte-vêtements. Base en bois recouverte de moquette, disponible en rouge ou bleu - Support en tube d'acier tubulaire en laiton ou chromé \varnothing 40 mm - Bord de butoir périphérique en caoutchouc - Roues multidirectionnelles \varnothing 200 mm.

DE Kofferwagen und Kleiderständer. Holzboden mit buntem Teppichboden, erhältlich in den Farben Rot oder Blau - Stabhalterung aus vermessingt oder verchromtem Stahlrohr \varnothing 40 mm - Gummistoßschutz - Mehrrichtungsräder \varnothing 200 mm.

	ABX-PV4062	ABX-PV4064	ABX-PV4055	ABX-PV4056
	95 x 55 x 190(h) cm		95 x 55 x 183(h) cm	
	Base rossa + Struttura ottone Red base + Brass structure	Base blu + Struttura cromata Blue base + Chromed structure	Base rossa + Struttura ottone Red base + Brass structure	Base blu + Struttura cromata Blue base + Chromed structure
	150 Kg			
	FUORI PRODUZIONE-OT OF PRODUCTION	1.015 €	FUORI PRODUZIONE-OT OF PRODUCTION	895 €

ABX-PV2001



ABX-PV2001I



WARNING

ABX-PV2021



ABX-PV2021I



IT Carrelli portavaligie e portabiti. Base in legno ricoperta da moquette colorata, disponibile in rosso - supporto asta in tubolare di acciaio ottonato o inox da \varnothing 40 mm - bordo paracolpi perimetrale in gomma - ruote multidirezionali \varnothing 200 mm.

EN Luggage trolleys and clothes racks. Wooden base covered with coloured carpet, available in red - rod support in brass-plated steel or stainless steel tube \varnothing 40 mm - perimeter rubber shock absorber - multidirectional wheels \varnothing 200 mm.

FR Chariots à bagages et porte-vêtements. Base en bois recouverte de moquette, disponible en rouge - support en tube d'acier tubulaire en laiton ou acier inox \varnothing 40 mm - bord de butoir périphérique en caoutchouc - roues multidirectionnelles \varnothing 200 mm.

DE Chariots à bagages et porte-vêtements. Base en bois recouverte de moquette, disponible en rouge - support en tube d'acier tubulaire en laiton ou acier inox \varnothing 40 mm - bord de butoir périphérique en caoutchouc - roues multidirectionnelles \varnothing 200 mm.

IT Carrelli portavaligie e portabiti. Base in legno ricoperta da moquette colorata, disponibile nei colori rosso o nera - supporto asta in tubolare di acciaio ottonato o inox da \varnothing 40 mm - bordo paracolpi perimetrale in gomma - ruote pneumatiche \varnothing 200 mm.

EN Luggage trolleys and clothes racks. Wooden base covered with coloured carpet, available in red or black - rod support in brass-plated steel or stainless steel tube \varnothing 40 mm - perimeter rubber shock absorber - pneumatic wheels \varnothing 200 mm.

FR Chariots à bagages et porte-vêtements. Base en bois recouverte de moquette, disponible en rouge ou noir - support en tube d'acier tubulaire en laiton ou acier inox \varnothing 40 mm - bord de butoir périphérique en caoutchouc - roues pneumatiques \varnothing 200 mm.

DE Kofferwagen und Kleiderständer. Holzboden mit buntem Teppichboden, erhältlich in den Farben Rot oder Schwarz - Stabhalterung aus vermessingt Stahl oder Edelstahlrohr \varnothing 40 mm - Gummistoßschutz - Lufträder \varnothing 200 mm.

	ABX-PV2001	ABX-PV2001I
	124 x 64 x 190(h) cm	
	Base rossa + Struttura ottone Red base + Brass structure	Base rossa + Struttura inox Red base + Stainless steel structure
	150 Kg	
	1.140 €	1.050 €

	ABX-PV2021	ABX-PV2021I
	110 x 62 x 198(h) cm	
	Base rossa + Struttura ottone Red base + Brass structure	Base nero + Struttura inox Black base + Stainless steel structure
	150 Kg	
	1.000 €	990 €





ABX-PV2002**ABX-PV2002I****ABX-PV2003****ABX-PV2003I**

IT Carrelli portavaligie. Base pieghevole e pianali in legno ricoperti di moquette colorata rossa - struttura disponibile in acciaio ottonato o inox - 2 piedi di appoggio - ruote ø 250 mm.

EN Luggage trolleys. Foldable base and wooden shelves covered with red carpet - structure available in brass or stainless steel - 2 support feet - wheels ø 250 mm.

FR Chariot à bagages. Base repliable et étagères en bois recouvertes de moquette de couleur rouge - structure disponible en acier laitoné ou en acier inox - 2 pieds de support - roues ø 250 mm.

DE Kofferwagen. Klappboden und Holzabstellflächen mit rotem Teppichboden - Struktur wahlweise aus vermessingtem Stahl oder Edelstahl - 2 Standfüße - Räder ø 250 mm.

	ABX-PV2002	ABX-PV2002I	ABX-PV2003	ABX-PV2003I
	56 x 83 x 123(h) cm		56 x 70 x 120(h) cm	
	Base rossa + Struttura ottone Red base + Brass structure	Base rossa + Struttura inox Red base + Stainless steel structure	Base rossa + Struttura ottone Red base + Brass structure	Base rossa + Struttura inox Red base + Stainless steel structure
	100 Kg			
	300 €	280 €	245 €	210 €

ABX-PVI4024



IT Carrello porta valigie e portabiti. Struttura in tubo di acciaio inox - base in lamiera d'acciaio inox - ruote multidirezionali \varnothing 140 mm, di cui 2 fisse.

EN Luggage trolley and clothes rack Structure in stainless steel tube - base in stainless steel plate - multidirectional wheels \varnothing 140 mm, 2 of which fixed.

FR Chariots à bagages et porte-vêtements. Structure en tube d'acier inox - base en tôle d'acier inox - roues multidirectionnelles \varnothing 140 mm, dont 2 fixes.

DE Kofferwagen und Kleiderständer. Struktur aus Edelstahlrohr - Boden aus Edelstahlblech - Mehrwegräder \varnothing 140 mm, 2 davon fest.

ABX-ST4060



IT Stender portabiti. Struttura in tubo di acciaio cromato - asta allungabile di 30 cm per lato - ruote multidirezionali.

EN Clothes rack. Chrome-plated steel tube structure - rod can be extended by 30 cm on each side - multidirectional wheels.

FR vêtements rack. Structure en tube d'acier chromé - bras extensible de 30 cm de chaque côté - roues multidirectionnelles.

DE Kleiderständer. Verchromte Stahlrohrstruktur - der Stab lässt sich auf jeder Seite um 30 cm verlängern - Mehrwegräder.

	ABX-PVI4024
	100 x 56 x 160(h) cm
	200 Kg
	485 €

	ABX-ST4060
	Open 210 x 53 x 152(h) cm Closed 150 x 53 x 152(h) cm
	112 €



ABX-RE4016



ABX-RE4017



ABX-RE4018



ABX-RE4019



ABX-RE4016

IT Reggivaligie. Struttura in legno - telo in cotone.

EN Luggage holder. Wooden structure - cotton strap.



FR Supports de bagages. Structure en bois - toile de coton.

DE Kofferträger. Holzrahmen - Baumwolltuch.

MERCE IN ESAURIMENTO ULTIMI PEZZI
OUT OF STOCK

FUORI PRODUZIONE
OUT OF PRODUCTION

	ABX-RE4016 faggio-beech wood	ABX-RE4017 noce-walnut
	50 x 46 x 58(h) cm	
	65 €	

	ABX-RE4018 faggio-beech wood	ABX-RE4019 noce-walnut
	50 x 41 x 58(h) cm	
	65 €	

ABX-CPB1472

ABX-CPB1474



IT Carrello per trasporto pesante. Pianale basso in lamiera di acciaio inox - manico smontabile - ruote multidirezionali \varnothing 140 mm di cui 2 fisse e dotate di freno.

EN Trolleys for heavy transport Lower platform in stainless steel plate - removable handle - multidirectional wheels \varnothing 140 mm, 2 of which fixed and equipped with brake.

FR Chariot de transport lourd. Etagère basse en tôle d'acier inox - poignée amovible - roues multidirectionnelles \varnothing 140 mm, dont 2 fixes et équipées de freins.

DE Wagen für den Schwertransport. Niedrige Ladefläche aus Edelstahlblech - abnehmbarer Griff - Mehrwegräder \varnothing 140 mm, 2 davon fest und mit Bremse ausgestattet.

	ABX-CPB1474	ABX-CPB1472
 cm	61 x 122 x 90(h) cm	61 x 110 x 85(h) cm
	1 manico 1 handle	2 manici 2 handles
 MAX Kg	200 Kg	
	470 €	500 €

 Carrelli per trasporto pesante
Trolleys for heavy transport

ABX-CA1473





IT Carrello portacasse. Struttura in tubo di acciaio verniciato - ruote \varnothing 200 mm piene.

EN Trunk trolley. Structure in painted steel tube - \varnothing 200 mm full wheels.

FR Chariot pour caisse. Structure en tube d'acier peint - roues pleines \varnothing 200 mm.

DE Kistenwagen. Struktur aus lackiertem Stahlrohr - \varnothing 200 mm Vollräder.

	ABX-CA1473
 cm	50 x 45 x 105(h) cm
 MAX Kg	200 Kg
	FUORI PRODUZIONE _ OUT OF PRODUCTION

ABX-ACF5190



NERO/BLACK



ORO/GOLD

ACCIAIO
STEEL

IT Aste delimita corsie. Disponibili in diverse misure con nastro avvolgibile colorato rosso o blu - asta colore oro, acciaio inox o nera. Puntali in abbinamento.

EN Retractable Barriers Available in different sizes with red or blue colored retractable belts - gold, stainless steel or black post. Matching caps.

FR Délimiteur de zone. Disponible en différentes tailles avec ruban roulant de couleur rouge ou bleue - mât en or, acier inox ou noir. Pointe coordonnée.

DE Begrenzungspfosten. Erhältlich in verschiedenen Größen mit rotem oder blauem Aufrollband - Gold, Edelstahl oder schwarze Pfosten. Passende Spitzen.

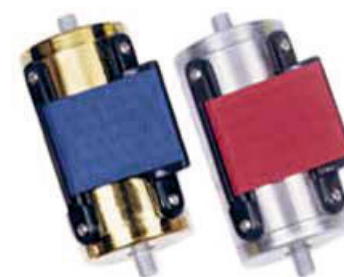

ABX-PU 5195

IT Puntali in abbinamento delle aste delimita corsie a seconda del colore e materiale scelto.

EN Caps matching the posts of the retractable barriers according to the colour and material chosen.

FR Pointes coordonnées avec les mâts de délimitation des voies en fonction de la couleur et du matériau choisi.

DE Spitzen passend zu den Begrenzungspfosten je nach Farbe und Material.

	ABX-ACF5190 DB Blu-Blue	ABX-ACF5190 DR Rosso-Red
	2 mt	
	Asta dorata Golden post	
	ABX-ACF5190IB Blu-Blue	ABX-ACF5190IR Rosso-Red
	2 mt	
	Asta acciaio lucido Polished steel post	
	ABX-ACF5190NB Blu-Blue	ABX-ACF5190NR Rosso-Red
	2 mt	
	Asta nera Black post	
	90 €	

	ABX-PU5195DB Blu-Blue	ABX-PU5195DR Rosso-Red	ABX-PU5195IB Blu-Blue	ABX-PU5195IR Rosso-Red	ABX-PU5195NB Blu-Blue	ABX-PU5195NR Rosso-Red
	Puntale dorato Gold cap		Puntale acciaio lucido Polished steel cap		Puntale nero Black cap	
	40 €					

ABX-AC5118D ABX-AC5118I



ORO/GOLD



ACCIAIO
STEEL



IT Aste delimita corsie per cordoni a treccia. Puntali in abbinamento.
EN Barriers posts for plaited cords. Matching caps.
FR Délimiteur de zone pour cordons tressés. Pointe coordonnée.
DE Begrenzungspfosten für geflochtene Seile. Passende Spitzen.

	ABX-AC5118D	ABX-AC5118DI
	90(h) cm	
	Asta dorata Golden post	Asta acciaio lucido Polished steel post
	90 €	



ABX-GA5144D ABX-GA5144I

IT Gancio a muro, disponibile in colore ottonato o cromato.
EN Wall ring, available in brass or chrome colour.
FR Anneau à mur, disponible en couleur laiton ou chromé.
DE Wandhaken, erhältlich in vermessingter oder verchromter Farbe.



	ABX-GA5144D	ABX-GA5144I
	Gancio ottonato Brass-plated wall ring	Gancio inox Stainless steel wall ring
	22 €	

ABX-CO4099

IT Cordone per aste. Colori: bordeaux, oro, verde, blu.
EN Barriers cord. Colours: burgundy, gold, green, blue.
FR Cordon pour délimiteur. Couleurs: bordeaux, or, vert, bleu.
DE Begrenzungsseile. Farben: Burgunder, Gold, Grün, Blau.



	ABX-CO4099	
	ø 30 mm	
	45 € al metro / meter	

ABX-PU5144D ABX-PU5144I

IT Puntali in abbinamento delle aste delimita corsie per cordoni a treccia.
EN Caps matching the posts of the barriers with plaited cords.
FR Pointes coordonnées avec les mâts pour cordons tressés.
DE Spitzen passend zu den Begrenzungspfosten für geflochtene Seile.



	ABX-PU5144D	ABX-PU5144I
	Puntale dorato Gold cap	Puntale acciaio lucido Polished steel cap
	25 €	

ABX-LU4120

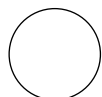

BIANCO/WHITE



ABX-LU4131

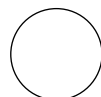

BIANCO/WHITE



**FUORI PRODUZIONE
OUT OF PRODUCTION**

IT Macchina pulisci scarpe. Struttura in lamiera verniciata a polveri epossidiche - spazzole in cotone e crine - pulsante di accensione con temporizzatore elettrico. Dispensatore per crema - disponibile solo in colore bianco.

EN Shoe cleaner machine. Structure in metal plate painted with epoxy powders - cotton and horsehair brushes - power button with electric timer. Cream dispenser - available colors white.

FR Machine de nettoyage de chaussures. Structure en tôle peinte avec poudres époxy - brosses en coton et crin de cheval - bouton d'alimentation avec minuterie électrique. Distributeur de crème - disponible en blanc.

DE Schuhputzmaschine. Struktur aus mit Epoxidpulvern lackiertem Blech - Baumwoll- und Rosshaarbürsten - Einschaltknopf mit elektrischer Zeitschaltuhr. Cremespender - erhältlich in weiß.

IT Macchina pulisci scarpe. Struttura in lamiera verniciata a polveri epossidiche - spazzole in cotone e crine - pulsante di accensione con temporizzatore elettrico.

EN Shoe cleaner machine. Structure in metal plate painted with epoxy powders - cotton and horsehair brushes - power button with electric timer.

FR Machine de nettoyage de chaussures. Structure en tôle peinte avec poudres époxy - brosses en coton et crin de cheval - bouton d'alimentation avec minuterie électrique.

DE Schuhputzmaschine. Struktur aus mit Epoxidpulvern lackiertem Blech - Baumwoll- und Rosshaarbürsten - Einschaltknopf mit elektrischer Zeitschaltuhr.

	ABX-LU4120
	150 W
 1 Ph	230V-50HZ
 cm	62 x 30 x 83(h) cm
FUORI PRODUZIONE	

	ABX-LU4131
	150 W
 1 Ph	230V-50HZ
 cm	42 x 30 x 83(h) cm
OUT OF PRODUCTION	



Carrelli portabiancheria

riifornimento frigobar, pulizia e multiuso

ABX-CA1501



ABX-CA1505



ABX-CA1510



ABX-CA1515



IT Carrelli portabiancheria. Struttura in acciaio inox - piani in laminato - in dotazione un sacco in tessuto ignifugo - paracolpi in gomma - ruote multidirezionali ø 125 mm.

EN Laundry trolleys. Stainless steel structure - laminate shelves - fireproof fabric bag included - rubber shock absorbers - multidirectional wheels ø 125 mm.

FR Chariots à linge. Structure en acier inox - dessus en stratifié - sac en tissu ignifuge inclus - butoir en caoutchouc - roues multidirectionnelles ø 125 mm.



DE Wäschereiwagen. Edelstahlstruktur - Laminatoberflächen - feuerfester Gewebesack inbegriffen - Gummistoßschutz - Mehrwegräder ø 125 mm.



NOCE/WALNUT



WENGÉ

	ABX-CA1501 noce-walnut	ABX-CA1505 noce-walnut	ABX-CA1505W wengé	ABX-CA1510 noce-walnut	ABX-CA1510W wengé	ABX-CA1515 noce-walnut	ABX-CA1515W wengé
	79 x 43 x 129(h) cm	70/100 x 50 x 123(h) cm		90/143 x 50 x 123(h) cm		110/143 x 50 x 123(h) cm	
	3	4		4		4	
	-	1 bracciaio pieghevole 1 folding arm		2 braccia pieghevoli 2 folding arms		2 braccia pieghevoli 2 folding arms	
	330 €	630 €		670 €		680 €	

ABX-CA740



ABX-CA1525



IT Carrello portabiancheria. Struttura in acciaio inox - piani in laminato - 2 portasacchi, in dotazione un sacco in tessuto ignifugo - cassetto superiore porta accessori - paracolpi in gomma - ruote multidirezionali ø 125 mm.

EN Laundry trolley. Stainless steel structure - laminate shelves - 2 bag holders, supplied with a fireproof fabric bag - upper drawer for accessories - rubber shock absorber - multidirectional wheels ø 125 mm.

FR Chariot à linge. Structure en acier inox - étagères en stratifié - 2 porte-sacs, fournis avec un sac en tissu ignifugé - tiroir supérieur porte-accessoires - butoir en caoutchouc - roues multidirectionnelles ø 125 mm.

DE Wäschereiwagen. Edelstahlstruktur - Laminatoberflächen - 2 Sackhalter, feuerfester Gewebesack inbegriffen - obere Schublade für Zubehörteile - Gummistoßschutz - Mehrwegräder ø 125 mm.

IT Carrello portabiancheria. Struttura in acciaio inox - piani in acciaio inox - 2 portasacchi, in dotazione un sacco in tessuto ignifugo - cassetto superiore porta accessori in acciaio inox - paracolpi in gomma - ruote multidirezionali ø 125 mm.

EN Laundry trolley. Stainless steel structure - stainless steel shelves - 2 bag holders, supplied with a fireproof fabric bag - stainless steel upper drawer for accessories - rubber shock absorber - multidirectional wheels ø 125 mm.

FR Chariot à linge. Structure en acier inox - étagères en acier inox - 2 porte-sacs, fournis avec un sac en tissu ignifugé - tiroir supérieur porte-accessoires en acier inox - butoir en caoutchouc - roues multidirectionnelles ø 125 mm.

DE Wäschereiwagen. Edelstahlstruktur - Edelstahloberflächen - 2 Sackhalter, feuerfester Gewebesack inbegriffen - obere Schublade aus Edelstahl für Zubehörteile - Gummistoßschutz - Mehrwegräder ø 125 mm.

	ABX-CA740 noce-walnut
	82/152 x 50 x 158(h) cm
	4 piani + cassetta 4 layers + upper drawers
	2 braccia pieghevoli 2 folding arms
	1.000 €

	ABX-CA1525 inox
	75/142 x 55 x 152(h) cm
	4 piani + cassetta 4 layers + upper drawers
	2 braccia pieghevoli 2 folding arms
	1.190 €

ABX-CA1530



- IT** Carrello portabiancheria, pulizia e multiuso. Struttura in lamiera verniciata a polveri epossidiche - 2 portasacchi, in dotazione un sacco in tessuto ignifugo - vaschetta porta detersivi superiore - ruote ø 140 mm, di cui 2 fisse e 2 girevoli.
- EN** Laundry, cleaning and multi-purpose trolley. Structure in epoxy powder coated sheet - 2 bag holders, supplied with a fireproof fabric bag - upper detergent tray - wheels ø 140 mm, 2 of which fixed and 2 swivelling.
- FR** Chariot à linge, nettoyage et polyvalent. Structure en tôle d'acier peinte avec des poudres époxydiques - 2 porte-sacs, fournis avec un sac en tissu ignifugé - plateau supérieur à détergent - roues ø 140 mm, dont 2 fixes et 2 pivotantes.
- DE** Wäscherei-, Reinigungs- und Mehrzweckwagen. Struktur aus mit Epoxidpulvern beschichtetem Blech - 2 Sackhalter, feuerfester Gewebesack inbegriffen - obere Waschmittelablage - Räder ø 140 mm, davon 2 fest und 2 schwenkbar.

	ABX-CA1530
	80/153 x 50 x 158(h) cm
	3 piani + 2 portasacchi 3 layers + 2 bag holders
	2 braccia pieghevoli 2 folding arms
	1.310 €

Optional

ABX-A520

ABX-CA1501 | ABX-CA1505 | ABX-CA1510 | ABX-CA1515 | ABX-CA1530 | ABX-CA740
ABX-CA1525 | ABX-CA1530

sacco in tela ignifugo
fireproof fabric bag sac
en tissu ignifugé
feuerfester Gewebesack

68 €

ABX-A515

ABX-CA1501 | ABX-CA1505 | ABX-CA1510 | ABX-CA1515 | ABX-CA1530 | ABX-CA740 | ABX-CA1525

Ruote con freno
Wheels with brake
Roues avec frein
Räder mit Bremsen

17 € cad./each

ABX-A518

ABX-CA1530

Ruote con freno
Wheels with brake
Roues avec frein
Räder mit Bremsen



25 € cad./each

ABX-CR1696



IT Carrello rifornimento frigo e multuso. Struttura in lamiera verniciata a polveri epossidiche - vaschetta laterale per la raccolta dei vuoti, asportabile - ruote ø 140 mm, di cui 2 fisse e 2 girevoli.

EN Multipurpose and mini bar filling trolley. Structure in epoxy powder coated plate - side tray for collecting dirt, removable - wheels ø 140 mm, of which 2 fixed and 2 swivelling.

FR Chariot pour le remplissage mini bar et polyvalent. Structure en tôle peinte à la poudre époxy - plateau latéral de vidange, démontable - roues de ø 140 mm, dont 2 fixes et 2 pivotantes.

DE Minibar- und Mehrzweckwagen. Struktur aus mit Epoxidpulvern beschichtetem Blech - seitliche Ablage zum Entleeren, abnehmbar - Räder ø 140 mm, davon 2 fest und 2 drehbar.

	ABX-CR1696
	80 x 50 x 118(h) cm
	4 vaschette / side trays
	1.050 €

Optional

ABX-A1001

Cestino piccolo
Small basket
Petit panier
Kleiner Korb

12 €

ABX-A1002

Cestino grande
Large basket
Grand panier
Großer Korb

28 €

ABX-A518

Ruote con freno
Wheels with brake
Roues avec frein
Räder mit Bremsen

25 € cad./each



ABX-CA1696
CON OPTIONAL
WITH OPTIONAL



ABX-CA3203

OPTIONAL
ABX-A525

Sacco a tela
Fabric bag
Sac de toile
Gewebesack

52 €



- IT Cestone portabiancheria pieghevole con sacco in tela e ruote multidirezionali.
- EN Folding laundry basket with fabric bag and multidirectional wheels.
- FR Sac à linge pliable avec sac en toile et roues multidirectionnelles.
- DE Faltbarer Wäschekorb mit Gewebesack und Mehrwegräder.

	ABX-CA3203
	62 x 64 x 100(h) cm
	225 €

ABX-CA1580

OPTIONAL
ABX-A521

Sacco a tela
Fabric bag
Sac de toile
Gewebesack

78 €



ABX-CA1584

- IT Carrello pieghevole plastificato. Struttura in tubo e tondino di acciaio elettroverniciato - ruote multidirezionali Ø" 80 mm.
- EN Plastic-coated folding basket. Structure in electro-varnished steel tube and rod - multidirectional wheels.
- FR Corbeille pliante plastifié. Structure en tube et tige d'acier électrovernissé - roues multidirectionnelles.
- DE Faltbarer Kunststoffwäschekorb. Struktur aus elektrolackiertem Stahlrohr - Mehrwegräder.

	ABX-CA1580
	80 x 51 x 72(h) cm
	140 €

ABX-CA1584

OPTIONAL
ABX-A531

Sacco a tela
Fabric bag
Sac de toile
Gewebesack

82 €

- IT Carrello pieghevole rinforzato con struttura tubolare Ø30mm laccato - ruote a forcella Ø 100 mm.
- EN Reinforced folding trolley with lacquered tubular structure Ø30 mm - fork wheels Ø 100 mm.
- FR Chariot pliant renforcé à structure tubulaire laquée Ø30 mm - roues à fourches Ø 100 mm.
- DE Verstärkter Klappwagen mit lackierter Rohrstruktur Ø30 mm - Gabelräder Ø 100 mm.

	ABX-CA1584
	100 x 60 x 87(h) cm
	360 €

ABX-CA1599



ABX-CA1599E



IT Secchio carrellato con strizzatore. Struttura di rialzo per inserimento prodotti pulizia - manico cromato ad incastro con impugnatura in gomma antiscivolo.

EN Bucket with wringer on wheels. Elevated structure for the insertion of cleaning products - chromed handle with non-slip rubber grip.

FR Seau sur roues avecessoreuse. Structure de rehausse pour l'insertion des produits de nettoyage - manche chromé avec poignée antiglisse en caoutchouc.

DE Fahrbarer Mopp Eimer mit Presse. Erhöhte Struktur für den Einsatz von Reinigungsmitteln - verchromter Griff mit rutschfestem Gummigriff.

IT Secchio carrellato con strizzatore.

EN Bucket with wringer on wheels.

FR Seau sur roues avecessoreuse.

DE Fahrbarer Mopp Eimer mit Presse.

	ABX-CA1599
	55 x 27 x 87(h) cm
	180 €

	ABX-CA1599E
	60 x 40 x 92(h) cm
	90 €

ABX-CA1604



ABX-CA1604E



ABX-A570 STRIZZATORE PLASTICA CON INGRANAGGI
IN PLASTICA- PLASTIC SQUEEZER WITH
MECHANISM

- IT Secchio carrellato con strizzatore in nylon - 2 secchi da 25 L - maniglione reversibile - ruote multidirezionali da \varnothing 80 mm.
- EN Bucket with nylon wringer on wheels - 2x25 L buckets - reversible handle - multidirectional wheels \varnothing 80 mm.
- FR Seau sur roue avecessoreuse en nylon - 2 seaux de 25 litres - poignée réversible - roues multidirectionnelles \varnothing 80 mm.
- DE Fahrbarer Mopp Eimer mit Nylonpresse - 2x25 L. Eimer - Wendegriff - Mehrwegräder \varnothing 80 mm.

	ABX-CA1604
	69 x 42 x 85(h) cm
	200 €

ABX-RC0875 SECCHIO IN PLASTICA ROSSO /RED BUCKET
ABX-RC0874 SECCHIO IN PLASTICA BLU /BLUE BUCKET
ABX-RC0876 STRIZZATORE /WRINGER

- IT Secchio carrellato con strizzatore in nylon - 2 secchi da 17 L - maniglione reversibile - ruote multidirezionali da \varnothing 80 mm.
- EN Bucket with nylon wringer on wheels - 2x17 L buckets - reversible handle - multidirectional wheels \varnothing 80 mm.
- FR Seau sur roue avecessoreuse en nylon - 2 seaux de 17 litres - poignée réversible - roues multidirectionnelles \varnothing 80 mm.
- DE Fahrbarer Mopp Eimer mit Nylonpresse - 2x17 L. Eimer - Wendegriff - Mehrwegräder \varnothing 80mm.

	ABX-CA1604E
	71 x 43 x 93(h) cm
	160 €

ABX-CA1613

A540 RICAMBIO MOP IN COTONE
400 GR. SPARE COTTON MOP

A550 PINZA PLASTICA GIGANTE PER MOP.
GIANT PLASTIC PINCER FOR MOP

A560 MANICO LEGNO VERNICIATO
DIAM.24 -150 Cm.
WOODEN HANDLE D. 24 -150 C



IT Carrello per pulizia. Telaio e impugnatura in plastica - secchio, strizzatore e cassette in plastica - strizzatore in plastica a libro senza fondo - portasacco da 120 L completo di rinforzi e coperchio - 2 secchielli da 4 L e 1 secchio da 28 L - gancio portapaletta e gancio portamanico con rullo in gomma.

EN Cleaning trolley Plastic frame and handle - plastic bucket, wringer and trays - plastic wringer without bottom - 120 L bag holder complete with reinforcements and lid - 2x4 L buckets and 1x28 L bucket. - dustpan hook and handle hook with rubber roller.

FR Chariot pour le nettoyage. Corps et poignée en plastique - seau, essoreuse et bacs en plastique - essoreuse en plastique sans fond - porte-sac de 120 L. complet avec renforts et couvercle - 2 seaux de 4 L. et 1 seau de 28 L. - crochet pour palette et manche avec rouleau en caoutchouc.

DE Reinigungswagen. Kunststoffrahmen und -griff - Eimer, Presse und Behälter aus Kunststoff - Kunststoffpresse ohne Boden - 120 L. Sackhalterung komplett mit Verstärkungen und Deckel - 2x4 L. Eimer und 1x28 L. Eimer - Kehrblech- und Griffhaken mit Gummirolle.

ABX-CA1614



IT Carrello per pulizia. Telaio e impugnatura in plastica - secchio, strizzatore e cassetta in plastica media - portasacco - 2 secchielli da 4 L e 1 secchio da 15 L - ganci portascopo - ruote ø 100 mm. Il porta vaschette superiore non è incluso.

EN Cleaning trolley Plastic frame and handle - bucket, wringer and medium plastic tray - bag holder - 2 buckets of 4 L and 1 bucket of 15 L - broom hook - wheels ø 100 mm. The upper tray holder is not included.

FR Chariot pour le nettoyage. Corps et poignée en plastique - seau, essoreuse et bac moyen en plastique moyenne - porte-sac - 2 seaux de 4 L. et 1 seau de 15 L. - crochets porte balai - roues ø 100 mm. Le porte bacs supérieur n'est pas inclus.

DE Reinigungswagen. Kunststoffrahmen und -griff - Eimer, Presse und mittelgroßer Behälter aus Kunststoff - Sackhalterung - 2x4 L. Eimer und 1x15 L. Eimer - Besenhaken - Räder ø 100 mm. Der obere Ablagefachhalter ist nicht inbegriffen.

	ABX-CA1613
	107 x 56 x 111(h) cm
	420 €

	ABX-CA1614
	92 x 55 x 124(h) cm
	450 €

ABX-CA1615

ABX-A540 RICAMBIO MOP IN COTONE
400 GR. SPARE COTTON MOP

ABX-A550 PINZA PLASTICA GIGANTE
PER MOP.
GIANT PLASTIC PINCER FOR MOP

ABX-A560 MANICO LEGNO
VERNICIATO
DIAM.24 -150 Cm.
WOODEN HANDLE D. 24 -150 C



ABX-CA1616

Coperchio superiore di
colore blu non incluso
-Blue lid not included.



IT Carrello per la pulizia. Telaio e impugnatura in plastica - secchio, strizzatore e cassetta in plastica media - portasacco - 2 secchielli da 4 L e 2 secchi da 15 L - ganci portascopo - vano centrale con cassetto scorrevole - ruote \varnothing 100 mm. Portavaschette superiore non incluso.

EN Cleaning trolley Plastic frame and handle - bucket, wringer and medium plastic tray - bag holder - 2x4 L buckets and 2x15 L buckets - broom hook - central compartment with sliding drawer - wheels \varnothing 100 mm. The upper tray holder is not included.

FR Chariot pour le nettoyage. Corps et poignée en plastique - seau, essoreuse et bac moyen en plastique moyenne - porte-sac - 2 seaux de 4 L. et 2 seaux de 15 litres - crochets porte balai - compartiment central avec tiroir coulissant - roues \varnothing 100 mm. Le port bacs supérieur n'est pas inclus.

DE Reinigungswagen. Kunststoffrahmen und -griff - Eimer, Presse und mittelgroßer Behälter aus Kunststoff - Sackhalterung - 2x4 L. Eimer und 1x15 L. Eimer - Besenhaken - Mittelfach mit Schiebeschublade - Räder \varnothing 100 mm. Der obere Ablagefachhalter ist nicht inbegriffen.

IT Carrello per la pulizia. Telaio e impugnatura in plastica - secchio, strizzatore e cassetta in plastica media - cestino portabottiglie portasacco - 4 secchielli da 4 L e 2 secchi da 15 L - ganci portascopo - vano centrale con cassetto scorrevole - ruote \varnothing 100 mm. Coperchio superiore di colore blu non incluso nel prezzo.

EN Cleaning trolley Plastic frame and handle - bucket, wringer and medium plastic tray - bottle rack - bag holder - 2x4 L buckets and 2x15 L buckets - broom hook - central compartment with sliding drawer - wheels \varnothing 100 mm. Blue lid not included in the price.

FR Chariot pour le nettoyage. Corps et poignée en plastique - seau, essoreuse et bac moyen en plastique moyenne - corbeille pour bouteilles, porte-sac - 4 seaux de 4 L. et 2 seaux de 15 litres - crochets porte balai - compartiment central avec tiroir coulissant - roues \varnothing 100 mm. Couvercle supérieur bleu non compris dans le prix.

DE Reinigungswagen. Kunststoffrahmen und -griff - Eimer, Presse und mittelgroßer Behälter aus Kunststoff - Flaschenkorb und Sackhalterung - 2x4 L. Eimer und 1x15 L. Eimer - Besenhaken - Mittelfach mit Schiebeschublade - Räder \varnothing 100 mm. Blaue obere Abdeckung nicht im Preis inbegriffen.

	ABX-CA1615
	92 x 68 x 124(h) cm
	490 €

	ABX-CA1616
	133 x 68 x 124(h) cm
	800 €

ABX-CA1606E



ABX-CA1520



IT Carrello per pulizia. Telaio e impugnatura in plastica - secchio con strizzatore in plastica - portasacco con sacco da 120 L - attacco porta utensili.

EN Cleaning trolley Plastic frame and handle - bucket with plastic wringer - bag holder with 120 L bag - tool holder.

FR Chariot pour le nettoyage. Corps et poignée en plastique - seau avecessoreuse en plastique - porte-sac avec sac de 120 L. - porte-outils.

DE Reinigungswagen. Kunststoffrahmen und -griff - Eimer mit Kunststoffpresse - Sackhalterung mit 120 L. Sack - Werkzeughalteranschluss.

IT Carrello multiuso in plastica.

EN Multi-purpose plastic trolley.

FR Multi-purpose plastic trolley.

DE Mehrzweckwagen aus Kunststoff.

Carrelli per pulizia
Cleaning trolleys

	ABX-CA1606E
	114 x 51 x 98(h) cm
	250 €

	ABX-CA1520
	150 x 54 x 99(h) cm
	350 €





Articoli vari per la macelleria

ABX-LMMC



ABX-LMM



ABX-LM48M



IT Combinato lavamani più lavastracci in acciaio inox con rubinetto acqua calda/fredda.

EN Stainless steel combi hand washer and rags washer with hot / cold water tap.

FR Lave-mains combiné en acier inox avec robinet d'eau chaude / froide.

DE Handwasch- & Ausgussbecken übereinanderliegend mit Heiß / Kaltwassermischer.

IT Lavamani con mobile e comandi a ginocchio. Lavamani in acciaio inox su mobile con porte a battente - comando a ginocchio.

EN Hand washer on neutral element with knee lever. Stainless steel hand washer on cabinet with hinged doors - knee lever.

FR Lave-mains sur meuble neutre avec commande à genou. Lave-mains en acier inox sur meuble à portes battantes - commande à genou.

DE Handwaschbecken auf Schrank mit Kniehebel. Handwaschbecken auf Schrank mit Flügeltüren - Kniehebel.

	ABX-LMMC
	70 x 50 x 89(h) cm
	760 €

	ABX-LMM	ABX-LM48M
	50 x 40 x 85(h) cm	40 x 40 x 85(h) cm
	600 €	570 €

ABX-LC50MM



IT Lavamani e lavautensili con mobile. Lavamani e utensili su mobile in acciaio inox - porta battente - miscelatore acqua calda/fredda vasca da 40x40x25(h) cm.

EN Hand washer and tools washer on cabinet. Hand washer and tools washer on stainless steel cabinet - hinged door - hot / cold water tap, bowl 40x40x25(h) cm.

FR Lave-mains et lave-outils sur meuble. Lave-mains et lave-outils sur meuble en acier inox - porte battante - robinet d'eau chaude / froide cuve 40x40x25(h) cm.

DE Hand- und Werkzeugwaschbecken auf Schrank. Hand- und Werkzeugwaschbecken auf Edelstahlschrank - Flügeltür - 40x40x25(h) cm Heiß-/Kaltwassermischer.

	ABX-LC50MM
	50 x 50 x 85(h) cm
	800 €

ABX-LM40



ABX-LM48



ABX-LC50



IT Lavamani a colonna e comandi a ginocchio. Struttura in acciaio inox.

EN Pillar hand washer with knee lever. Stainless steel structure.

FR Colonne lave-mains avec commandes à genou. Structure en acier inox.

DE Säulenhandwaschbecken mit Kniehebel. Edelstahlstruktur.

	ABX-LM40	ABX-LM48	ABX-LC50
	40 x 40 x 32(h) cm	48 x 35 x 53(h) cm	50 x 40 x 80(h) cm
	280 €	390 €	390 €

ABX-SUV10





ABX-SUV14

ABX-SN38



- IT** Armadietto sterilizzatore a raggi UV costruito in acciaio inox AISI 304 Scotch Brite. Portina in plexiglas trasparente con microinterruttore - portacoltelli in acciaio inox - funzionamento con lampada germicida con griglia di protezione temporizzatore 60' e lampada spia di funzionamento - cavo con spina.
- EN** UV sterilizer cabinet made of Scotch Brite stainless steel AISI 304. Clear Plexiglas door with microswitch - stainless steel knife holder - operation with germicidal lamp with 60' timer protection grid and indicator lamp - cable with plug.
- FR** Armoire stérilisateur UV en acier inox Scotch Brite AISI 304. Porte en plexiglas transparent avec microinterrupteur - porte-couteau en acier inox - fonctionnement avec lampe germicide avec grille de protection, minuteur 60' et indicateur lumineux - câble avec fiche.
- DE** UV-Sterilisationsschrank aus Scotch Brite Edelstahl AISI 304. Tür aus klarem Plexiglas mit Mikroschalter - Messerhalter aus Edelstahl - Betrieb mit Keimtöteterlampe mit 60' Timer, Schutzgitter und Anzeigelampe - Kabel mit Stecker.

- IT** Sterilizzatori elettrici per coltelli. Struttura in acciaio inox - termostato regolabile interno +30 +110°C - rubinetto di carico e scarico.
- EN** Electric knives sterilizers Stainless steel structure - internal adjustable thermostat +30 +110°C - filling and emptying tap.
- FR** Stérilisateur électriques pour couteaux. Structure en acier inox - thermostat interne réglable +30 +110°C - robinet de remplissage et de vidange.
- DE** Elektrische Sterilisatoren für Messer. Edelstahlstruktur - innenliegender einstellbarer Thermostat +30 +110°C - Be- und Entladehahn.

	ABX-SUV10	ABX-SUV14
	16 W	
 1 Ph	230 V 50/60 HZ	
	N° 10 coltelli - knives	N° 14 coltelli - knives
 cm	43 x 16 x 64(h) cm	54 x 16 x 64(h) cm
	385 €	415 €

	ABX-SN38
	1500 W
 1 Ph	230 V 50/60 HZ
	N° 12 coltelli - knives
 cm	38 x 14 x 40(h) cm
	385 €

Antinfortunistica per Macelleria

ABX-AV4897 | ABX-AV4898

ABX-AV4900 | ABX-AV4901

i	ABX-AV4897
1	<p>Grembiule alluminio antinfortunistico con bretelle Aluminium safety apron with shoulder straps Tablier de sécurité en aluminium avec sangles d'épaule Aluminium Sicherheitsschürze mit Schultergurten</p>
	220 €

i	ABX-AV4898
2	<p>Grembiule acciaio inox antinfortunistico con bretelle Stainless steel safety apron with shoulder straps Tablier de sécurité en acier inox avec sangles d'épaule Edelstahl-Sicherheitsschürze mit Schultergurten</p>
	210 €

i	ABX-AV4900
3	<p>Guanto inox antinfortunistico a cinque dita con cinturino inox completamente sterilizzabile Five-finger stainless steel safety glove with stainless steel strap, fully sterilisable Gant de sécurité à cinq doigts en acier inox avec sangle en acier inox, entièrement stérilisable Edelstahl-Fünf-Finger-Sicherheitshandschuh mit Edelstahlband völlig sterilisierbar</p>
	165 €

i	ABX-AV4901
4	<p>Guanto inox antinfortunistico a cinque dita con chiusura a molla inox. Avambraccio compreso Stainless steel five finger safety glove with stainless steel spring fastening. Forearm included. Gant de sécurité à cinq doigts en acier inox avec fermeture à ressort en acier inox. Avant-bras inclus. Edelstahl-Fünf-Finger-Sicherheitshandschuh mit Edelstahl-Feder-Verschluss.</p>
	290 €



ABX-CCL

- IT** Ceppo in legno di acacia e sgabello. Ceppo trattato con vernice atossica e collanti ecologici (conformi alle norme vigenti) assemblato con innesti a pressione e internamente con inserti speciali in legno - batticarne ecologico e riciclabile - reversibile.
- EN** Acacia wood chopping block and stool. Chopping block treated with non-toxic paint and ecological adhesives (in compliance with current standards) assembled with pressure joints and internally with special wood inserts - ecological and recyclable meat beater - reversible.
- FR** Blocs de boucher en bois d'acacia et tabouret. Bloc traité avec peinture atoxique et adhésifs écologiques (conformes aux normes en vigueur) assemblés avec embrayages à pression et intérieur avec inserts spéciaux en bois - bloc à viande écologique et recyclable - réversible.
- DE** Metzger-Block aus Akazienholz und Hocker. Metzger-Block behandelt mit ungiftiger Farbe und ökologischen Klebstoffen (nach den gültigen Normen), zusammengebaut mit Steckverbindungen und speziellen innen Holzeinsätzen - umweltfreundlicher und wiederverwertbarer Fleischklopper - beidseitig.



i	ABX-CCL1744	ABX-CCL1745	ABX-CCL1755	ABX-CCL1764	ABX-CCL1766	ABX-CCL1774	ABX-CCL1774
↗ cm	40 x 40 x 90(h) cm	45 x 45 x 90(h) cm	50 x 50 x 90(h) cm	60 x 40 x 90(h) cm	60 x 60 x 90(h) cm	70 x 40 x 90(h) cm	70 x 50 x 90(h) cm
	580 €	640 €	750 €	750 €	1.000 €	830 €	1.000 €



SPESSORE / THICKNESS 17cm

i	ABX-CCL2544	ABX-CCL2555	ABX-CCL2564	ABX-CCL2566	ABX-CCL2574	ABX-CCL2575	ABX-CCL2577
↗ cm	40 x 40 x 90(h) cm	50 x 50 x 90(h) cm	60 x 40 x 90(h) cm	60 x 60 x 90(h) cm	70 x 40 x 90(h) cm	70 x 50 x 90(h) cm	70 x 70 x 90(h) cm
	725 €	935 €	935 €	1.150 €	990 €	1.150 €	1.370 €



SPESSORE / THICKNESS 25cm

i	ABX-CCL3555	ABX-CCL3566	ABX-CCL3575	ABX-CCL3577	ABX-CCL3586
↗ cm	50 x 50 x 90(h) cm	60 x 60 x 90(h) cm	70 x 50 x 90(h) cm	70 x 70 x 90(h) cm	80 x 60 x 90(h) cm
	1.150 €	1.430 €	1.430 €	1.775 €	1.775 €



SPESSORE / THICKNESS 35cm

ABX-CCP

IT Ceppo in polietilene e sgabello in acciaio inox AISI 304.

EN Polyethylene block and AISI 304 stainless steel stool.

FR Bloc en polyéthylène et tabouret en acier inox AISI 304.

DE Polyethylenblock und Hocker aus Edelstahl AISI 304.



	ABX-CCP8000	ABX-CCP8001	ABX-CCP8002	ABX-CCP8003
	40 x 40 x 88(h) cm	50 x 50 x 88(h) cm	70 x 50 x 88(h) cm	60 x 60 x 88(h) cm
	490 €	600 €	680 €	730 €

	ABX-CCP8004	ABX-CCP8005	ABX-CCP8006
	70 x 70 x 88(h) cm	80 x 60 x 88(h) cm	100 x 50 x 88(h) cm
	880 €	805 €	850 €

ABX-KCP

IT Copriceppo di polietilene bianco.

EN White polyethylene block cover.

FR Couverture en polyéthylène blanc.

DE Weiße Polyethylenabdeckung.



ABX-CPE

IT Ceppo di polietilene alimentare bianco.

EN Chopping block made of white food grade polyethylene.

FR Bloc en polyéthylène alimentaire.

DE Polyethylenblock .



	ABX-KCP2501	ABX-KCP2502	ABX-KCP2503	ABX-KCP2504
	40 x 40 x 2,5(h) cm	50 x 50 x 2,5(h) cm	60 x 40 x 2,5(h) cm	60 x 60 x 2,5(h) cm
	96 €	145 €	140 €	190 €

	ABX-KCP2505	ABX-KCP2506	ABX-KCP2508
	70 x 40 x 2,5(h) cm	70 x 50 x 2,5(h) cm	70 x 70 x 2,5(h) cm
	155 €	190 €	250 €

	ABX-CPE40408	ABX-CPE50508	ABX-CPE70508	ABX-CPE60608
	40 x 40 x 8(h) cm	50 x 50 x 8(h) cm	70 x 50 x 8(h) cm	60 x 60 x 8(h) cm
	210 €	300 €	370 €	400 €

	ABX-CPE70708	ABX-CPE80608	ABX-CPE100508
	70 x 70 x 8(h) cm	80 x 60 x 8(h) cm	100 x 50 x 8(h) cm
	520 €	470 €	470 €

ABX-TP

IT Taglieri in polietilene. Colore bianco.

EN Polyethylene cutting boards. Colour: white.

FR Planches à découper en polyéthylène. Couleur blanche.

DE Schneidebretter aus Polyethylen. Farbe: weiß.



GIALLO/YELLOW



MARRONE/BROWN



VERDE/GREEN



BLU/BLUE



ROSSO/RED

Per scelta colore aggiungere al codice:

For colour choice add to code:

Pour choisir la couleur, ajoutez au code:

Fügen Sie für die Farbauswahl den Code hinzu:

Y = Giallo / Yellow / Gelb / Jaune

M = Marrone / Brown / Braun / Marron

G = Verde / Green / Grün / Vert

B = Blu / Blue / Blau / Bleu

R = Rosso / Red / Rot / Rouge

ABX-RASK

ABX-RICRA

IT RASK: Raschietto per pulizia ceppi e taglieri
compreso di 4 lamette.

EN RASK: Scraper for butcher blocks and cutting boards cleaning.
RICRA: Spare blade for scraper

FR RASK: Racloir pour le nettoyage des blocs et des planches à découper.
RICRA: Lame de rechange pour racloir

DE RASK: Schaber zum Reinigen von Metzger-Blöcke und Schneidbrettern.
RICRA: Ersatzklinge für Schaber.



ABX-RASK

	ABX-RASK
	46 €

	ABX-TP40302	ABX-TP50302	ABX-TP50402	ABX-TP60402
	40 x 30 x 2(h) cm	50 x 30 x 2(h) cm	50 x 40 x 2(h) cm	60 x 40 x 2(h) cm
	46 €	46 €	46 €	73 €

	ABX-TP70402	ABX-TP80402	ABX-TP50302	ABX-TP60402
	70 x 40 x 2(h) cm	80 x 40 x 2(h) cm	50 x 30 x 2(h) cm Y/M/G/B/R	60 x 40 x 2(h) cm Y/M/G/B/R
	85 €	91 €	46 €	73 €

Scaffalatura modulare Modular shelving



IT Scaffalatura modulare in alluminio anodizzato. Design rispondente alle norme igieniche con superfici lisce ed arrotondate, profili chiusi e totale assenza di spazi o fessure - leghe di alta qualità resistenti all'usura prodotta da agenti chimici, termici e meccanici - ampia scelta di misure - possibilità di inserimento vaschette serie Gastronorm GN1/2-GN1/1-GN2/1-GN2/3 inserite all'interno dei ripiani.

EN Modular shelving in anodized aluminium. Design in compliance with hygiene standards with smooth and rounded surfaces, closed profiles and total absence of spaces or gaps - high quality alloys resistant to wear produced by chemical, thermal and mechanical agents - wide choice of sizes - possibility of inserting Gastronorm containers GN1/2-GN1/1-GN2/1-GN2/3 inside the shelves.

FR Rayonnage modulaire en aluminium anodisé. Design hygiénique avec des surfaces lisses et arrondies, des profilés fermés et absence totale d'espaces ou de fissures - alliages de haute qualité résistants à l'usure par des agents chimiques, thermiques et mécaniques - large choix de dimensions - possibilité d'insérer des bacs Gastronorm GN1/2-GN1/1-GN2/1-GN2/1-GN2/3 dans les étagères.

DE Modulare Regale aus eloxiertem Aluminium. Design nach Hygienestandards mit glatten und abgerundeten Oberflächen, geschlossenen Profilen und völliger Abwesenheit von Zwischenräumen oder Rissen - hochwertige, verschleißfeste Legierungen gegen chemischen, thermischen und mechanischen Werkstoffen - umfangreiche Größenauswahl - Behältern der Serie Gastronorm GN1/2-GN1/1-GN2/1-GN2/1-GN2/3, in den Regalen einsetzbar.

IT Ripiani in alluminio completi di griglie in polietilene. Composti da: 2 fiancate, 4 attacchi, serie griglie.

EN Aluminium shelves complete with polyethylene grids. Composed of: 2 sides, 4 brackets, grids.

FR Étagères en aluminium complètes avec des grilles en polyéthylène. Composé de: 2 côtés, 4 supports, série de grilles.

DE Aluminiumzwischenetagen komplett mit Polyethylen-Gittern. Bestehend aus: 2 Seitenpaneele, 4 Halterungen, Gittern.

i	ABX-R62	ABX-R88	ABX-R97	ABX-R106
	Max. 240 kg	Max. 180 kg	Max. 170 kg	Max. 150 kg
↗ cm	37,3 x 62 cm	37,3 x 88,6 cm	37,3 x 97,4 cm	37,3 x 106,2 cm
	70 €	78 €	82 €	85 €

i	ABX-R115	ABX-R124	ABX-R133	ABX-R150
	Max. 140 kg	Max. 130 kg	Max. 110 kg	Max. 90 kg
↗ cm	37,3 x 115,2 cm	37,3 x 124 cm	37,3 x 133 cm	37,3 x 150,5 cm
	95 €	105 €	110 €	120 €

IT Testata in alluminio completa di: 2 piantane, 3 traversini, 2 piedi e 2 tappi.

EN Stainless steel front panel. Complete with: 2 pillars, 3 crosspieces, 2 feet and 2 plugs.

FR Façade en aluminium. Complète avec: 2 montants, 3 traverses, 2 pieds et 2 capuchons

DE Edelstahlfrontblende. Komplett mit: 2 Träger, 3 Qwerstäbe, 2 Füße und 2 Kappen.

Giunzioni per angolo.
Corner joints.
Joints de coin.
Eckverbindungen.

i	ABX-F15	ABX-F17	ABX-F20	ABX-GA373
↗ cm	37,3 x 155(h) cm	37,3 x 170(h) cm	37,3 x 200(h) cm	37,3 cm
	110 €	110 €	120 €	26 €

ABX-SE30



ABX-FT30

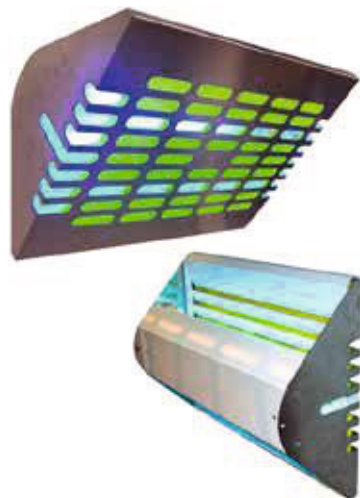

ABX-PZ30N



- IT** Elettroinsetticidi a lampade UVA. Materiale alluminio. Potenza 30W. Lampade 2x15W - possibilità di montaggio in orizzontale o verticale - copertura fino a 80 mq.
- EN** Electro-insecticides with UVA lamps. Material: Aluminium Power 30W. 2x15W lamps - horizontal or vertical installation - surface cover up to 80 sqm.
- FR** Electro-insecticides avec lampes UVA. Matériel : aluminium. Puissance 30W. 2 Lampes 15W - possibilité de montage horizontal ou vertical - portée jusqu'à 80 m².
- DE** Elektroinsekt-Killer mit UVA-Lampen. Material: Aluminium. Leistung 30W. 2x15W Lampen - horizontale oder vertikale Montage möglich - Reichweite bis zu 80 qm.

	ABX-SE30	ABX-FT30	ABX-PZ30N
	32 x 14 x 54(h) cm	48 x 36 x 16(h) cm	55 x 11 x 26(h) cm
	245 €	270 €	140 €

Optional

ABX-CRS30
ABX-SE30

ABX-CR30
ABX-FT30

Collante di ricambio confezione da 6 pezzi
Spare glue pack of 6 pieces
Colle de rechange 6 pièces
Ersatzkleber 6 Stück-Packung

40 €

54 €

ABX-L617

ABX-PZ30N | ABX-FT30 | ABX-SE30

Lampada da 15 W
15 W lamp
Lampe 15 W
15 W Lampe

12 €



Attrezzatura per la colazione



ABX-CD7905



ABX-CD9801



IT Chafing dish con coperchio. Struttura rettangolare in acciaio inox - bruciatori ad alcool.

EN Chafing dish with lid. Rectangular stainless steel casing - alcohol burners.

FR Chafing Dish avec couvercle. Corps rectangulaire en acier inox - Brûleurs à alcool.

DE Chafing Dish mit Deckel. Rechteckige Edelstahlstruktur - Alkohol-Brenner.

IT Chafing dish con coperchio roll top. Struttura in acciaio inox lucido - bruciatori ad alcool.

EN Chafing dish with roll top lid. Rectangular polished stainless steel casing - alcohol burners.

FR Chafing Dish avec couvercle supérieur roll top. Corps rectangulaire en acier inox poli - Brûleurs à alcool.

DE Chafing Dish mit Roll-Top Deckel. Rechteckige polierte Edelstahlstruktur - Alkohol-Brenner.

	ABX-CD7905
	67 x 37 x 41(h) cm - 8,5 L
	120 €

	ABX-CD9801
	65 x 47 x 45(h) cm - 8,5 L
	280 €



ABX-CD6502



ABX-CD6504



IT Chafing dish con coperchio roll top 180°. Struttura in acciaio inox lucido - bruciatori ad alcool.

EN Chafing dish with roll top lid 180°. Rectangular polished stainless steel casing - alcohol burners.

FR Chafing Dish avec couvercle supérieur roll top 180°. Corps rectangulaire en acier inox poli - Brûleurs à alcool.

DE Chafing Dish mit 180° Roll-Top Deckel. Rechteckige polierte Edelstahlstruktur - Alkohol-Brenner.

IT Chafing dish tondo con coperchio roll top 180°. Struttura in acciaio inox lucido - bruciatori ad alcool.

EN Round Chafing dish with roll top lid 180°. Rectangular polished stainless steel casing - alcohol burners.

FR Chafing Dish ronde avec couvercle supérieur roll top 180°. Corps rectangulaire en acier inox poli - Brûleurs à alcool.

DE Rundes Chafing Dish mit 180° Roll-Top Deckel. Rechteckige polierte Edelstahlstruktur - Alkohol-Brenner.

	ABX-CD6502
	65 x 47 x 45 (h) cm - 8,5 L
	520 €

	ABX-CD6504
	50 x 52 x 45 (h) cm - 6 L
	485 €

ABX-CD6505



- IT** Chafing dish con coperchio roll top 180° e pentole da 4,6 L. Struttura in acciaio inox lucido - bruciatori ad alcool.
- EN** Chafing dish with roll top lid 180° and 4,6 L pans. Rectangular polished stainless steel casing - alcohol burners.
- FR** Chafing Dish avec couvercle supérieur roll top 180° t marmites de 4,6 L. Corps rectangulaire en acier inox poli - Brûleurs à alcool.
- DE** Chafing Dish mit 180° Roll-Top Deckel und 4,6 L. Töpfe. Rechteckige polierte Edelstahlstruktur - Alkohol-Brenner.

	ABX-CD6505
	65 x 47 x 45 (h) cm
	620 €

Optional

ABX-AV9516

ABX-CD7905 | ABX-CD9801 | ABX-CD6502 | ABX-CD6504 | ABX-CD6505

Elemento di riscaldamento elettrico per Chafing Dishes 230 V 50/60 Hz 360 W.

Electric heating element for Chafing Dishes 230 V 50/60 Hz 360 W.

Élément électrique de chauffage pour Chafing Dishes 230 V 50/60 Hz 360 W.

Elektrischer Heizelement für Chafing Dishes 230 V 50/60 Hz 360 W.

115 €

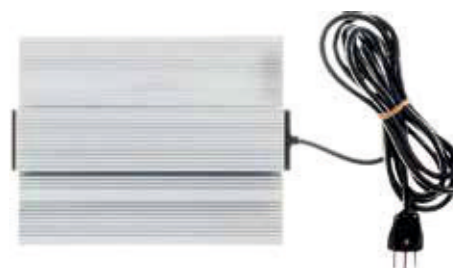

ABX-AV9517

ABX-DC10502

Elemento elettrico riscaldante 180 W. Per ABX-DC10502

Electric heating element 180 W. For ABX-DC10502

Élément électrique chauffant 180 W. Pour ABX-DC10502

Elektrischer Heizelement 180 W. Für ABX-DC10502

100 €



ABX-B8001



ABX-DC10502



IT Zuppiera elettrica. Corpo in alluminio verniciato - contenitore e coperchio in acciaio inox.

EN Electric soup tureen. Painted aluminium casing - stainless steel container and lid.

FR Soupière électrique. Corps en aluminium peint - récipient et couvercle en acier inox.

DE Elektrische Terrine. Gehäuse aus lackiertem Aluminium - Behälter und Deckel aus Edelstahl.

IT Distributore caldo per caffè. Struttura in acciaio inox - bruciatore ad alcool.

EN Hot coffee dispenser. Stainless steel casing - alcohol burner.

FR Distributeur de café chaud. Corps en acier inox poli - Brûleurs à alcool.

DE Heißkaffeespender. Gehäuse aus Edelstahl - Alkohol-Brenner.

Distributori caffè, bevande e cereali
Coffee, drinks and cereals dispensers

	ABX-B8001
	230 V 230 V 50Hz - 360 W
	ø 35 x 36(h) cm
	10 L
	270 €

	ABX-DC10502
	33 x 24 x 54(h) cm
	9 L
	320 €

ABX-DCN1706



ABX-DS10401



ABX-DS10402



IT Distributore caldo per caffè. Struttura in ABS con copertura in acciaio inox - dotata di termica di sicurezza - temperatura 90°C.

EN Hot coffee dispenser. ABS structure with stainless steel cover - equipped with safety thermic - temperature 90 ° C.

FR Distributeur de café chaud. Corps en ABS avec couvercle en acier inox - équipée d'un thermique de sécurité - température 90°C.

DE Heißkaffeenspender. ABS-Gehäuse mit Edelstahlabdeckung - ausgestattet mit Sicherheitsthermik - Temperatur 90 ° C

IT Distributore bevande. Contenitore trasparente - tubo centrale per contenimento ghiaccio.

EN Beverage dispenser. Clear container - central tube for ice filling.

FR Distributeur de boissons. Récipient transparent - tube central pour contenir de la glace.

DE Getränkespender. Klarer Behälter - Zentralrohr für die Eiseinführung.

	ABX-DCN1706
	230 V 50Hz- 1100 W
	ø 29 x 44(h) cm
	7 L (40 tazzine - cup)
	210 €

	ABX-DS10401	ABX-DS10402
	27 x 22 x 58(h) cm	32 x 32 x 58(h) cm
	8 L	5 + 5 L
	260 €	480 €

ABX-DC10301



ABX-DC10302



- IT Distributore per cereali. Contenitori trasparenti, singoli o doppi.
- EN Cereals dispenser. Clear containers, single or double.
- FR Distributeur de céréales. Récipients transparents, simples ou doubles.
- DE Müslispender. Transparente Behälter, einfach oder doppelt.

	ABX-DC10301	ABX-DC10302
	36 x 26 x 66(h) cm	48 x 26 x 66(h) cm
	8 L	8 + 8 L
	200 €	420 €

ABX-AV4561

- IT Fornello flambé a gas in rame con griglia in acciaio inox.
- EN Copper gas flambé cooker with stainless steel grid.
- FR Cuisinière flambée à gaz en cuivre avec grille en acier inox.
- DE Flambé Gasherd aus Kupfer mit Edelstahlgitter.



	ABX-AV4561
	ø 26 x 29,5(h) cm
	460 €

Fornello Flambé
Flambé cooker

ABX-AV4580

- IT Padella flambé inox-cuprum, manico legno.
- EN Flambé pan stainless steel-cuprum, wooden handle.
- FR Poêle flambée en acier inox-cuprum, manche en bois.
- DE Flambé Cuprum-Pfanne aus Edelstahl mit Holzgriff.

ABX-AV4581



	ABX-AV4580	ABX-AV4581
	ø 29 cm	ø 26 cm
	180 €	140 €

Padella Flambé
Flambé pan







Articoli vari

per cucina e pizzeria

BACINELLE - CONTAINERS BASSINES - BEHÄLTER		i	↗ cm	L	
MOD. 2/1 Est. 646 x 530 mm Int. 620 x 500 mm		ABX-GNI21200	20(h) cm	60 L	150 €
		ABX-GNI21150	15(h) cm	44,9 L	130 €
		ABX-GNI21100	10(h) cm	31,5 L	96 €
		ABX-GNI2165	6,5(h) cm	18,9 L	76 €
		ABX-GNI2140	4(h) cm	12 L	70 €
		ABX-GNI2120	2(h) cm	6,5 L	67 €
		ABX-GRI21	Griglia - Grill		60 €
MOD. 1/1 Est. 530 x 325 Int. 500 x 300		ABX-GNI11200	20(h) cm	30 L	81 €
		ABX-GNI11150	15(h) cm	20,6 L	70 €
		ABX-GNI11100	10(h) cm	13,3 L	50 €
		ABX-GNI1165	6,5(h) cm	8,5 L	38 €
		ABX-GNI1140	4(h) cm	5,5 L	34 €
		ABX-GNI1120	2(h) cm	2,5 L	29 €
		ABX-COPI11	Coperchio Lid		32 €
		ABX-COPG11	Coperchio a tenuta Leak-proof lid		76 €
		ABX-FFF11	Falso fondo forato Perforated false bottom		29 €
		ABX-GRI11	Griglia - Grill		38 €
		ABX-S530	Separatore Divider		11 €
MOD. 2/3 Est. 352 x 325 Int. 329 x 300		ABX-GNI23200	20(h) cm	19,3 L	68 €
		ABX-GNI23150	15(h) cm	13,6 L	57 €
		ABX-GNI23100	10(h) cm	8,9 L	36 €
		ABX-GNI2365	6,5(h) cm	5,5 L	27 €
		ABX-GNI2340	4(h) cm	3,5 L	25 €
		ABX-GNI2320	2(h) cm	1,8 L	22 €
		ABX-COPI23	Coperchio Lid		21 €
		ABX-COPG23	Coperchio a tenuta Leak-proof lid		62 €
		ABX-FFF23	Falso fondo forato Perforated false bottom		24 €
		ABX-GRI23	Griglia - Grill		30 €

ACCIAIO INOX AISI 304 S/STEEL AISI 304

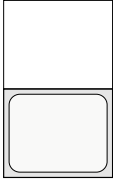
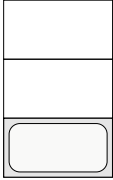
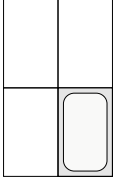

BACINELLE - CONTAINERS BASSINES - BEHÄLTER			 cm		
MOD. 1/2 Est. 325 x 265 Int. 300 x 238 	ABX-GNI12200		20(h) cm	11,6 L	53 €
	ABX-GNI12150		15(h) cm	9,9 L	41 €
	ABX-GNI12100		10(h) cm	8 L	29 €
	ABX-GNI1265		6,5(h) cm	4,2 L	22 €
	ABX-GNI1240		4(h) cm	2,5 L	19 €
	ABX-GNI1220		2(h) cm	1,2 L	16 €
	ABX-COPI12	Coperchio Lid			18 €
	ABX-COPG12	Coperchio a tenuta Leak-proof lid			55 €
	ABX-FFF12	Falso fondo forato Perforated false bottom			16 €
	ABX-S325	Separatore Divider			8 €
MOD. 1/3 Est. 325 x 176 Int. 300 x 150 	ABX-GNI13200		20(h) cm	8,1 L	44 €
	ABX-GNI13150		15(h) cm	5,9 L	33 €
	ABX-GNI13100		10(h) cm	3,8 L	22 €
	ABX-GNI1365		6,5(h) cm	2,5 L	19 €
	ABX-GNI1340		4(h) cm	1,5 L	16 €
	ABX-GNI1320		2(h) cm	0,7 L	14 €
	ABX-COPI13	Coperchio Lid			13 €
	ABX-COPG13	Coperchio a tenuta Leak-proof lid			46 €
	ABX-FFF13	Falso fondo forato Perforated false bottom			13 €
MOD. 1/4 Est. 265 x 162 INT. 238 x 136 	ABX-GNI14200		20(h) cm	4,9 L	36 €
	ABX-GNI14150		15(h) cm	4,1 L	28 €
	ABX-GNI14100		10(h) cm	2,5 L	20 €
	ABX-GNI1465		6,5(h) cm	1,9 L	16 €
	ABX-GNI1440		4(h) cm	1 L	15 €
	ABX-GNI1420		2(h) cm	0,5 L	12 €
	ABX-COPI14	Coperchio Lid			11 €
	ABX-COPG14	Coperchio a tenuta Leak-proof lid			40 €
	ABX-S265	Separatore Divider			8 €



BACINELLE - CONTAINERS BASSINES - BEHÄLTER		i	↗ cm	L	
MOD. 1/6 Est. 176 x 162 Int. 140 x 153		ABX-GNI16200	20(h) cm	3 L	39 €
		ABX-GNI16150	15(h) cm	2,5 L	25 €
		ABX-GNI16100	10(h) cm	1,6 L	17 €
		ABX-GNI1665	6,5(h) cm	1,1 L	14 €
		ABX-COPI16	Coperchio Lid		9 €
		ABX-COPG16	Coperchio a tenuta Leak-proof lid		42 €
MOD. 1/9 Est. 176 x 108 Int. 140 x 100		ABX-GNI19100	10(h) cm	0,9 L	18 €
		ABX-GNI1965	6,5(h) cm	0,5 L	13 €
		ABX-COPI19	Coperchio Lid		8 €



ATTENZIONE i coperchi a tenuta possono essere applicati solo su bacinelle GN con H mm. 100, 150 e 200

ATTENTION the leak-proof lids can only be applied to GN basins with H 100, 150 and 200 mm.





ATTENTION les couvercles anti-fuite ne peuvent être appliqués que sur des bassines GN avec H 100, 150 et 200 mm.

ACHTUNG Die versiegelten Deckel können nur bei GN-Behältern mit H 100,150 und 200mm eingesetzt werden.



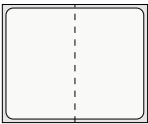

ACCIAIO INOX AISI 304 S/STEEL AISI 304

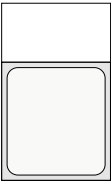
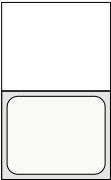
BACINELLE FORATE - PIERCED BASINS CUVETTES PERCÉES - LOCHSCHALE		i	↗ cm	L	
MOD. 2/1 Est. 646 x 530 mm Int. 620 x 500 mm		ABX-GNT21200	20(h) cm	60 L	202 €
		ABX-GNT21150	15(h) cm	44,9 L	169 €
		ABX-GNT21100	10(h) cm	31,5 L	123 €
		ABX-GNT2165	6,5(h) cm	18,9 L	114 €
MOD. 1/1 Est. 530 x 325 Int. 500 x 300		ABX-GNT11200	20(h) cm	30 L	98 €
		ABX-GNT11150	15(h) cm	20,6 L	83 €
		ABX-GNT11100	10(h) cm	13,3 L	55 €
		ABX-GNT1165	6,5(h) cm	8,5 L	49 €
MOD. 2/3 Est. 352 x 325 Int. 329 x 300		ABX-GNT23200	20(h) cm	19,3 L	77 €
		ABX-GNT23150	15(h) cm	13,6 L	65 €
		ABX-GNT23100	10(h) cm	8,9 L	42 €
		ABX-GNT2365	6,5(h) cm	5,5 L	39 €
MOD. 1/2 Est. 325 x 265 Int. 300 x 238		ABX-GNT12200	20(h) cm	11,6 L	61 €
		ABX-GNT12150	15(h) cm	9,9 L	49 €
		ABX-GNT12100	10(h) cm	8 L	38 €
		ABX-GNT1265	6,5(h) cm	4,2 L	25 €





TEGLIE CON FONDO FORATO TRAYS WITH PERFORATED BOTTOM					
MOD. 2/1 Est. 646 x 530 mm Int. 620 x 500 mm		ABX-GNF2120	2(h) cm	6,5 L	80 €
		ABX-GNF2140	4(h) cm	12 L	83 €
		ABX-GNF2165	6,5(h) cm	18,9 L	84 €
MOD. 1/1 Est. 530 x 325 Int. 500 x 300		ABX-GNF1120	2(h) cm	2,5 L	33 €
		ABX-GNF1140	4(h) cm	5,5 L	37 €
		ABX-GNF1165	6,5(h) cm	8,5 L	40 €
MOD. 2/3 Est. 352 x 325 Int. 329 x 300		ABX-GNF2320	2(h) cm	1,8 L	25 €
		ABX-GNF2340	4(h) cm	3,5 L	28 €
		ABX-GNF2365	6,5(h) cm	5,5 L	30 €
MOD. 1/2 Est. 325 x 265 Int. 300 x 238		ABX-GNF1220	2(h) cm	1,2 L	19 €
		ABX-GNF1240	4(h) cm	2,5 L	21 €
		ABX-GNF1265	6,5(h) cm	4,2 L	25 €





BACINELLE GN IN POLICARBONATO GN POLYCARBONATE CONTAINERS					
MOD. 1/1 Est. 530 x 325 Int. 500 x 300		ABX-GNP11200	20(h) cm	30 L	38 €
		ABX-GNP11150	15(h) cm	20,6 L	30 €
		ABX-GNP11100	10(h) cm	13,3 L	25 €
		ABX-GNP1165	6,5(h) cm	8,5 L	20 €
		ABX-COPP11	53 x 32,5 cm	-	16 €
		ABX-GFP11	46 x 25,5 cm	-	10 €
MOD. 1/2 Est. 325 x 265 Int. 300 x 238		ABX-GNP12200	20(h) cm	11,6 L	18 €
		ABX-GNP12150	15(h) cm	9,9 L	15 €
		ABX-GNP12100	10(h) cm	8 L	12 €
		ABX-GNP1265	6,5(h) cm	4,2 L	10 €
		ABX-COPP12	32,5 x 26,5 cm	-	9 €
		ABX-GFP12	25 x 19 cm	-	8 €

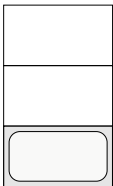
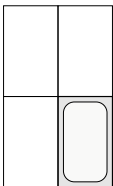
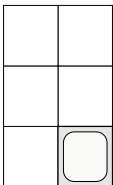
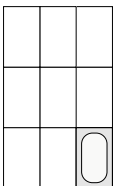



BACINELLE GN IN POLICARBONATO GN POLYCARBONATE CONTAINERS			 cm		
MOD. 1/3 Est. 325 x 176 Int. 300 x 150 	ABX-GNP13200	20(h) cm	8,1 L	15 €	
	ABX-GNP13150	15(h) cm	5,9 L	12 €	
	ABX-GNP13100	10(h) cm	3,8 L	10 €	
	ABX-GNP1365	6,5(h) cm	2,5 L	8 €	
	ABX-COPP13	32,5 x 17,6 cm	-	7 €	
	ABX-GFP13	25 x 11 cm	-	5 €	
MOD. 1/4 Est. 265 x 162 INT. 238 x 136 	ABX-GNP14200	20(h) cm	4,9 L	13 €	
	ABX-GNP14150	15(h) cm	4,1 L	10 €	
	ABX-GNP14100	10(h) cm	2,5 L	8 €	
	ABX-GNP1465	6,5(h) cm	1,9 L	7 €	
	ABX-COPP14	26,5 x 16,2 cm	-	5 €	
	ABX-GFP14	21 x 11 cm	-	5 €	
MOD. 1/6 Est. 176 x 162 Int. 140 x 133 	ABX-GNP16200	20(h) cm	3 L	10 €	
	ABX-GNP16150	15(h) cm	2,5 L	8 €	
	ABX-GNP16100	10(h) cm	1,6 L	7 €	
	ABX-GNP1665	6,5(h) cm	1,1 L	5 €	
	ABX-COPP16	17,6 x 16,2 cm	-	4 €	
	ABX-GFP16	11,5 x 10 cm	-	4 €	
MOD. 1/9 Est. 176 x 108 Int. 140 x 100 	ABX-GNP19100	10(h) cm	0,9 L	6 €	
	ABX-GNP1965	6,5(h) cm	0,5 L	5 €	
	ABX-COPP19	17,6 x 10 cm	-	4 €	





VASCHETTE PER GELATO ICE CREAM CONTAINERS					
	ABX-VG261612	26 x 16,5 x 12(h) cm	3,5 L	31 €	
	ABX-VG261615	26 x 16,5 x 15(h) cm	4 L	38 €	
	ABX-VG33168	33 x 16,5 x 8(h) cm	3,5 L	30 €	
	ABX-VG331612	33 x 16,5 x 12(h) cm	5 L	38 €	
	ABX-VG331615	33 x 16,5 x 15(h) cm	6,5 L	39 €	
	ABX-VG36168	36 x 16,5 x 8(h) cm	4 L	29 €	
	ABX-VG361612	36 x 16,5 x 12(h) cm	5,4 L	36 €	
	ABX-VG361615	36 x 16,5 x 15(h) cm	7 L	40 €	
	ABX-VG361618	36 x 16,5 x 18(h) cm	9 L	45 €	
	ABX-VG36258	36 x 25 x 8(h) cm	5 L	34 €	
ABX-VG362512	36 x 25 x 12(h) cm	8 L	36 €		
ABX-CR ø 200 H 250	Pozzetto inox per gelato Stainless steel ice-cream bowl			FP - OUT OF PRODUCTION	



TEGLIE SMALTATE ENAMELLED TRAYS GN1/1				
	ABX-GNS1120	GN1/1 20(h) cm	31 €	
	ABX-GNS1140	GN1/1 40(h) cm	33 €	
	ABX-GNS1165	GN1/1 65(h) cm	34 €	

COPERCHI IN PLASTICA PLASTIC LIDS				
	ABX-CP2		11 €	
	ABX-CP3		13 €	
	ABX-CP4		15 €	

SPATOLA - SPATULA				
	ABX-SPG	trasparente, rossa, blu, gialla Manico 26 cm.a Clear, red, blue, yellow Handle 26 cm	10 €	

ABX-AV4510



IT Morsa per prosciutto. Corpo in acciaio inox - supporto e manici in legno pregiato.

EN Ham stand. Stainless steel structure - support and handles in fine wood.

FR Serre-jambon. Corps en acier inox - support et poignées en bois de haute qualité.

DE Schinkengriff. Edelstahlkörper - Stütze und Griffe aus edlem Holz.

	ABX-AV4510
	58 x 25 x 19(h) cm
	160 €

ABX-AV4515



IT Morsa per prosciutto. Corpo in acciaio - supporto e manici in legno.

EN Ham stand. Stainless steel structure - support and handles in fine wood.

FR Serre-jambon. Corps en acier - support et poignées en bois.

DE Schinkengriff. Edelstahlkörper - Stütze und Griffe aus edlem Holz.

	ABX-AV4515
	58 x 25 x 19(h) cm
	70 €

ABX-AV4500

IT Apriscatole da banco. Struttura in acciaio cementato - coltello in acciaio inox - alzacerchi magnetico max 20(h) cm.

EN Counter can opener. Case hardened steel structure - stainless steel knife - magnetic lid lifter max 20(h) cm.

FR Ouvre-boîte pour comptoir. Structure en acier cémenté - couteau en acier inox - souleveuse de couvercle magnétique max 20(h) cm.

DE Tisch-Dosenöffner. Einsatzgehärtete Stahlstruktur - Edelmessner - Magnetdeckelheber Max 20(h) cm.



	ABX-AV4500	OPTIONAL ABX-R4501	OPTIONAL ABX-R4502
	10 x 23 x 69(h) cm	Lama di ricambio Spare blade	Ingranaggio ricambio Spare gear
	115 €	20 €	30 €

ABX-AV4585

ABX-AV4587

IT Vassoio in laminato in colore teak.

EN Teak laminate tray.

FR Plateau en teck laminé.

DE Laminattablette aus Teakholz.

ABX-AV4586



	ABX-AV4585	ABX-AV4586	ABX-AV4587
	Gastronorm 53x32,5 cm	Euronorm 53x37 cm	Esagonale 52x34,5 cm
	22 €	23 €	24 €

ABX-BL4545



ABX-BP4548



IT Bilancia Elettronica, fino a 15 kg con divisione in grammi 5. Corpo in ABS - piatto inox 28x21 cm - acquisizione tara - bolla di livello incorporata - tastiera con protezione antispruzzo - alimentazione a batteria ricaricabile - peso bilancia (batterie escluse) 4,1 kg. Non adatta per la vendita al pubblico.

EN Electronic Scale, up to 15 kg with division in 5 grams. - ABS casing - 28x21 cm stainless steel plate - tare acquisition - built-in level bubble - keyboard with splash protection - rechargeable battery power supply - scale weight (without batteries) 4,1 kg. Not suitable for retail sale.

FR Balance électronique, jusqu'à 15 kg avec division en 5 grammes. Corps en ABS - plaque en acier inox 28x21 cm - acquisition de la tare - bulle de niveau intégrée - clavier avec protection anti-rayures - alimentation par batterie rechargeable - poids balance (sans piles) 4,1 kg. Ne peut pas être vendue au public.

DE Elektronische Waage bis 15 kg mit Einteilung in Gramm 5. ABS Gehäuse - Edelstahltablette 28x21 cm - Tara-Erfassung - eingebaute Libelle - Tastatur mit Spritzschutz - Akku-Stromversorgung - Waagengewicht (ohne Batterien) 4,1 kg. Nicht für den Einzelhandel geeignet.

IT Bilancia Elettornica, fino a 60 kg con divisione in grammi 20. Corpo in ABS - piatto inox 32x33 cm - acquisizione tara - alimentazione a batteria + alimentatore - peso bilancia (batterie escluse) 4,5 kg. Non adatta per la vendita al pubblico.

EN Electronic Scale, up to 60 kg with division in 20 grams. ABS casing - 32x33 cm stainless steel plate - tare acquisition - battery power supply + transformer - scale weight (without batteries) 4,5 kg. Not suitable for retail sale.

FR Balance électronique, jusqu'à 60 kg avec division en 20 grammes. Corps en ABS - plaque en acier inox 32x33 cm - acquisition de la tare - alimentation par batterie + alimentation - poids de la balance (sans piles) 4,5 kg. Ne peut pas être vendue au public.

DE Elektronische Waage bis 60 kg mit Einteilung in Gramm 20. ABS Gehäuse - Edelstahltablette 32x33 cm - Tara-Erfassung - Akku-Stromversorgung + Netzteil - Waagengewicht (ohne Batterien) 4,5 kg. Nicht für den Einzelhandel geeignet.

	ABX-BL4545
	230V - 7 W
	29 x 33 x 22(h) cm
	365 €

	ABX-BP4548
	230V - 2 W
	31 x 30 x 5(h) cm
	285 €

ABX-AV4960



IT Pala in alluminio forata -per uso professionale

EN Perforated aluminium peel - for professional use

FR Pelle en aluminium perforée - pour usage professionnel

DE Perforierte Aluminiumschaufel - für den professionellen Einsatz

	ABX-AV4960	ABX-AV4961	ABX-AV4962	ABX-AV4963
	33 x 33 x 170(h) cm	36 x 36 x 170(h) cm	45 x 45 x 170(h) cm	50 x 50 x 170(h) cm
	196 €	208 €	241 €	254 €

ABX-AV4926

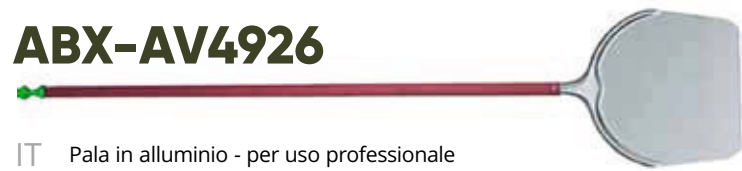

IT Pala in alluminio - per uso professionale

EN Aluminium peel - for professional use

FR Pelle en aluminium - pour usage professionnel

DE Aluminiumschaufel - für den professionellen Einsatz

	ABX-AV4926	ABX-AV4927	ABX-AV4930	ABX-AV4930/50
	33 x 33 x 170(h) cm	36 x 36 x 170(h) cm	45 x 45 x 170(h) cm	50 x 50 x 170(h) cm
	180 €	188 €	217 €	230 €

ABX-AV4925





IT Pala in alluminio

FR Pelle pizza en aluminium

EN Aluminium peel

DE Aluminiumschaufel

	ABX-AV4925	ABX-AV4928	ABX-AV4929
	33 x 33 x 135(h) cm	33 x 33 x 170(h) cm	36 x 36 x 170(h) cm
	113 €	128 €	139 €

ABX-AV4922





IT Palino in acciaio forato

FR Pelle de cuisson en acier perforé

EN Perforated steel turning peel

DE Perforierter Brotschieber

	ABX-AV4922	ABX-AV4923	ABX-AV4968
	ø 18 x 170(h) cm	ø 22 x 170(h) cm	ø 26 x 170(h) cm
	129 €	137 €	141 €



ABX-AV4920



IT Palino in acciaio

FR Pelle de cuisson en acier

EN Steel turning peel

DE Brotschieber

	ABX-AV4920	ABX-AV4921
	ø 18 x 170(h) cm	ø 22 x 170(h) cm
	113 €	121 €

ABX-AV4965

IT Pala in alluminio forni elettrici e a gas

EN Aluminium peel for electric and gas ovens

FR Pelle en aluminium fours électriques et à gaz

DE Aluminiumschaufel Elektro- und Gasöfen



	ABX-AV4965
	33 x 35 x 70(h) cm
	70 €

ABX-AV4966

IT Pala per pizza al metro

EN Peel for pizza by the meter

FR Pelle à pizza au mètre

DE Pizza am Stück Schaufel



	ABX-AV4966
	60 x 40 x 170(h) cm
	249 €

ABX-AV4905

IT Paletta servi pizza in acciaio

EN Steel pizza serving peel

FR Pelle pour servir des pizzas en acier

DE Pizza-Service Stahlschaufel



	ABX-AV4905	ABX-AV4931
	ø 50 cm a 8 porzioni ø 50 cm with 8 portions	ø 33 cm
	94 €	64 €

ABX-AV4948

IT Paletta per pizza triangolare in acciaio

EN Steel triangular pizza paddle

FR Pelle triangulaire en acier pour pizza

DE Dreieckiger Stahlschaufel für Pizza



	ABX-AV4948
	15 x 25 cm
	53 €

ABX-AV4932

IT Spatola in acciaio inox

EN Stainless steel spatula

FR Spatule en acier inox

DE Edelstahlspachtel



	ABX-AV4932
	22 €

ABX-AV4954

IT Paletta per pizza in acciaio

EN Steel pizza paddle

FR Pelle à pizza en acier

DE Stahlschaufel für Pizza



	ABX-AV4954
	10 x 15 cm
	32 €

ABX-CA1435

IT Pinza prenditeglie
EN Tray clamps
FR Pincés prend plaques
DE Blechklemme



ABX-AV4941

51 €

ABX-CA1437

IT Rotella taglia pizza professionale
EN Professional pizza cutter
FR Roue coupe-pizza professionnelle
DE Professionelles Pizzaschneidrad



ABX-AV4949



ø 9 cm

75 €

ABX-CA1435

IT Bucasfoglia in lega
EN Alloy puff pastry perforator
FR Perforateur de pâte feuilletée en alliage
DE Legierung Blätterteiglöcherer



ABX-AV4933

80 €

ABX-CA1437

IT Raschietto inox
EN Stainless steel scraper
FR Racloir inox
DE Edelstahl Schaber



ABX-AV4946



12 cm

24 €

ABX-CA1435

IT Rotella taglia pizza ø 90 mm
EN Pizza cutting wheel ø 90 mm
FR Molette coupe pizza ø 90 mm
DE Grädchen zur Pizza schneiden ø 90 mm



ABX-AV4934



ø 9 cm

29 €

ABX-CA1437

IT Paletta per cenere
FR Pelle à cendres
EN Peel for ashes
DE Ascheschaufel



ABX-AV4911



170(h) cm

112 €

ABX-AV4959



IT Spazzola ottone girevole a mezzaluna

EN Brass swivel half-moon brush

FR Brosse pivotante en laiton en forme de demi-lune

DE Schwenkbare Halbmondbürste aus Messing

	ABX-AV4959	OPTIONAL ABX-A45
	170(h) cm	ricambio spazzolone a mezzaluna spare half moon brush
	131 €	40 €

ABX-AV4971

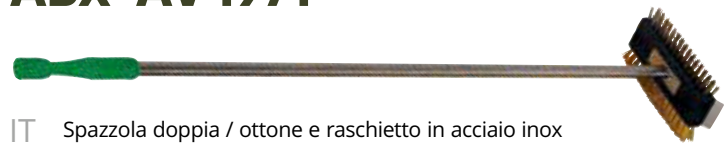

IT Spazzola doppia / ottone e raschietto in acciaio inox

EN Double brush / brass and stainless steel scraper

FR Brosse double / laiton et racloir inox

DE Doppelbürste / Messing und Edelstahlschaber

	ABX-AV4971
	110(h) cm
	80 €

ABX-AV4912



IT Spazzola in fibra naturale

EN Natural fibre brush

FR Brosse en fibres naturelles

DE Naturfaserbürste

	ABX-AV4912	OPTIONAL ABX-A42
	170(h) cm	Spazzola di ricambio in fibra naturale Natural fibre brush
	105 €	30 €

ABX-AV4919



IT Spazzola in ottone per forni a legno

EN Brass brush for wood ovens

FR Brosse en laiton pour fours à bois

DE Messingbürste für Holzöfen

	ABX-AV4919	OPTIONAL ABX-A43
	170(h) cm	spazzola di ricambio in ottone Spare brass brush
	118 €	32 €

ABX-AV4970



- IT Kit 3 pezzi 170(h) cm (pala ø 33 cm - palino ø 18 cm - spazzola)
 EN Kit 3 pieces 170(h) cm (ø 33 cm pizza peel - ø 18 cm turning peel - brush)
 FR Kit 3 pièces 170(h) cm (pelle ø 33 cm - pelle ø 18 cm - brosse)
 DE 3-teiliger Satz 170(h) cm (Schaufel ø 33 cm - kleine Schaufel ø 18 cm - Bürste)

	ABX-AV4970
	170(h) cm
	300 €

ABX-AV4972



- IT Kit 3 pezzi 135(h) cm (pala ø 33 cm - palino ø 22 cm - spazzola)
 EN Kit 3 pieces 135(h) cm (ø 33 cm pizza peel- ø 22 cm turning peel - brush)
 FR Kit 3 pièces 135(h) cm (pelle ø 33 cm - pelle ø 22 cm - brosse)
 DE 3-teiliger Satz 135(h) cm (Schaufel ø 33 cm - kleine Schaufel ø 22 cm - Bürste)

	ABX-AV4972
	135(h) cm
	224 €

	ABX-AV4916	
	Cassetta per appoggio pale Peel support box Cassette pour support de pelles Schaufelstützkasten	
		86 €

	ABX-AV4913	
	Supporto reggipale a muro Wall peel support Support mural pour pelles Wandschaufelhalter	
		56 €

	ABX-AV4914	
	Supporto reggipale a muro Wall peel support Support mural pour pelles Wandschaufelhalter	
		67 €

ABX-AV4910

- IT Supporto reggipale
 EN Peel support
 FR Support de palles
 DE Schaufelträger

	ABX-AV4910
	520x340x171(h) cm
	316 €



ABX-AV4935

IT Tagliere polietilene per pizza

EN Polyethylene cutting board for pizza

FR Planche à découper en polyéthylène pour pizza

DE Pizza-Schneidebrett aus Polyethylen



	ABX-AV4935	
	ø 35 cm	
	F.P - OUT OF PRODUCTION	

ABX-AV4952

IT Retina tonda inox

EN Little round stainless steel net

FR Grille ronde en acier inox

DE Rundes Edelstahlnetz

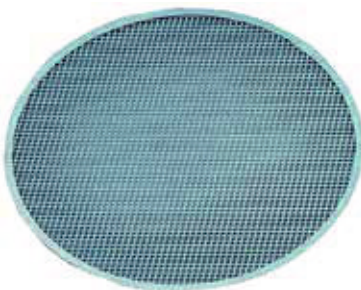

	ABX-AV4952	ABX-AV4953
	ø 33 cm	ø 45 cm
	29 €	43 €

ABX-AV4955

IT Retina tonda alluminio

EN Little round aluminium net

FR Grilleronde en aluminium

DE Rundes Aluminiumnetz



	ABX-AV4955	ABX-AV4956	ABX-AV4957
	ø 28 cm	ø 33 cm	ø 45 cm
	F.P - OUT OF PRODUCTION	20 €	27 €

ABX-AV4918

IT Alare per appoggio legna

EN Andiron stand for firewood

FR Chenet pour appui bois

DE Tragfläche für Holz



	ABX-AV4918	
	93 €	

ABX-AV4942

IT Oliera in acciaio inox 0,75 l

EN Stainless steel oil dispenser 0,75 L

FR Huilier en acier inox 0,75 L

DE Edelstahl Ölflasche 0,75 L



	ABX-AV4942	
	0,75 L	
	109 €	

ABX-AV4938

IT Contenitore per impasti pizza

EN Pizza dough container

FR Conteneur pour pâte à pizza

DE Pizzateigbehälter



	ABX-AV4938	ABX-AV4967	ABX-AV4939 Coperchio/Cover	ABX-AV4909
	60 x 40 x 7,5(h) cm	60 x 40 x 9(h) cm	60 x 40 cm	60 x 40 x 13(h) cm
	16 €	18 €	14 €	22 €



ABX-AV4973

- IT Portapizze rigido, interno in alluminio, per trasporto 10 pizze ø 33 cm.
- EN Sturdy pizza holder, internally made of aluminium, for 10 pizzas ø 33 cm.
- FR Conteneur thermique pour le transport de 10 pizza ø 33 cm, intérieur aluminium.
- DE Starres Pizzaregal aus Aluminium für den Transport von 10 Pizzas ø 33 cm.

	ABX-AV4973
	47 x 47 x 52(h) cm
	399 €



ABX-AV4975

- IT Borsa termica 5 pizze ø 33 cm per consegna a domicilio
- EN Heating Bag for 5 pizzas ø 33 cm for home delivery.
- FR Sac thermique pour 5 pizzas ø 33 cm pour la livraison à domicile.
- DE Wärmetasche für den Heimlieferdienst enthält 5 Pizzas ø 33 cm.

	ABX-AV4975
	37 x 37 x 20(h) cm
	62 €

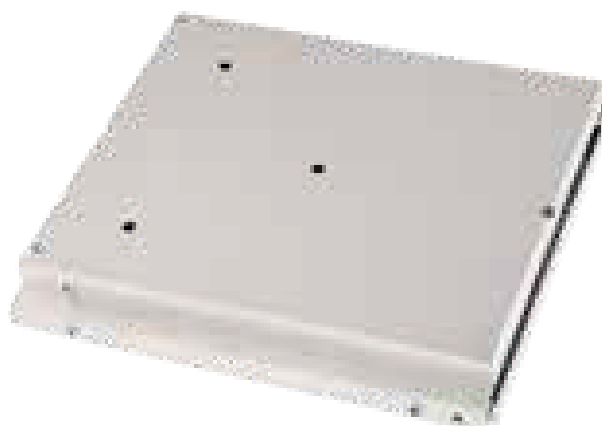

ABX-AV4974

- IT Piastra di fissaggio al portapacchi ciclomotore (per art. AV4973)
- EN Fixing plate for moped luggage rack (for art. AV4973)
- FR Plaque de fixation sur le porte-bagages du cyclomoteur (pour art. AV4973)
- DE Befestigungsplatte am Mopedgepäckträger (für Art. AV4973)

	ABX-AV4974
	35 x 37 x 6,5(h) cm
	110 €



Pattumiere-portarifiuti

ABX-AV465051

- IT Posacenere, gettacarte, pattumiere e portarifiuti - coperchio a rete cromata.
- EN Ashtrays, paper baskets, garbage bins and dust bins - chromed mesh lid.
- FR Cendriers, corbeilles à papier, poubelles et conteneur de déchets - couvercle en filet chromé.
- DE Aschenbecher, Papierkorb, Mülleimer und Abfallbehälter - verchromter Netzdeckel.



i	ABX-AV4650	ABX-AV4651
↗ cm	ø 20 - 60(h) cm	ø 25 - 70(h) cm
	108 €	176 €

ABX-AV4620

- IT Gettacarte in acciaio inox satinato Autoestinguente, testa soffocante per l'arresto della propagazione del fuoco - capacità 50 L - base in gomma.
- EN Satin stainless steel paper basket, Self-extinguishing, stifling end to stop the propagation of fire - capacity 50 L - rubber base.
- FR Corbeille à papier en acier inox satiné, Eteignant automatiquement, tête suffocante pour arrêter la propagation du feu - capacité 50 L - base en caoutchouc.
- DE Papierkorb aus satiniertem Edelstahl, Selbstlöschend erstickender Deckel zur Verhinderung der Ausbreitung von Feuer - Kapazität 50 L - Gummifuß.



i	ABX-AV4620
↗ cm	ø 31 - 59(h) cm
	176 €

ABX-AV466680

- IT Tramoggia su ruote. Struttura in acciaio inox satinato. coperchio asportabile.
- EN Hopper on wheels. Satin stainless steel casing. Removable lid.
- FR Trémie sur roues. Corps en acier inox satiné. Couvercle amovible.
- DE Trichter auf Rädern. Gehäuse aus Edelstahl matt geschliffen. Abnehmbarer Deckel.



i	ABX-AV4666	ABX-AV4680 con separatore interno with internal separator
↗ cm	61 x 40 x 73(h) cm	61 x 40 x 73(h) cm
L	115 L	
	496 €	576 €

ABX-AV4671

- IT Pattumiera con ruote, senza pedale.
- EN Garbage bin with wheels, without pedal.
- FR Poubelle à roulettes, sans pédale.
- DE Mülleimer mit Rädern, ohne Fußhebel.



i	ABX-AV4671
↗ cm	ø 39 x 60(h) cm
L	63 L
	295 €

ABX-AV4667
ABX-AV4668



ABX-AV4669



ABX-AV4660
ABX-AV4661
ABX-AV4663



- IT** Portarifiuti carrellato. Struttura a forma cilindrica in acciaio inox - completo di coperchio stampato - fondo a tenuta stagna - ruote multidirezionali. ABX-AV4667-68 con comando a pedale.
- EN** Wheeled waste bin. Cylindrical stainless steel structure - Complete with shaped lid - watertight bottom - multidirectional wheels. ABX-AV4667-68 with pedal control.
- FR** Chariot-poubelle. Corps cylindrique en acier inox - complète de couvercle imprimée - fond étanche - roues multidirectionnelles. ABX-AV4667-68 avec commande à pédale.
- DE** Abfalleimer auf Rädern. Zylindrisches Edelstahlgehäuse - mit vorgeformtem Deckel - wasserdichter Boden - Mehrwegräder. ABX-AV4667-68 mit Fußhebel.

- IT** Pattumiere tonde in acciaio inox. Cestello interno in metallo e pedale.
- EN** Round stainless steel waste bins. Internal metal basket and pedal.
- FR** Poubelles rondes en acier inox. Boîtier interne en métal et pédale.
- DE** Runde Abfalleimer aus Edelstahl. Interner Metallkorb und Fußhebel.

	ABX-AV4667	ABX-AV4668	ABX-AV4669
	ø 39 x 60(h) cm	ø 46 x 70(h) cm	ø 46 x 70(h) cm
	50 L	100 L	100 L
	246 €	294 €	227 €

	ABX-AV4660	ABX-AV4661	ABX-AV4663
	ø 32 x 59(h) cm	ø 32 x 74(h) cm	ø 41 x 71(h) cm
	30 L	40 L	80 L
	239 €	259 €	368 €

ABX-AV4652 ABX-AV4654



ABX-AV4681



IT Pattumiera rettangolare - Struttura in acciaio inox comando apertura a pedale - estrazione sacco anteriore - 2 ruote.

IT Pattumiera portasacco. Attacco rotondo in acciaio inox coperchio con apertura a pedale.

EN Rectangular waste bin - Stainless steel structure pedal opening control - front bag extraction - 2 wheels.

EN Bag holder. Round stainless steel fitting, lid with pedal opening.

FR Poubelle rectangulaire - Corps en acier inox commande d'ouverture par pédale - extraction du sac à l'avant - 2 roues.

FR Poubelle Porte-sac. Support rond en acier inox couvercle avec ouverture par pédale.

DE Rechteckiger Abfalleimer - Gehäuse aus Edelstahl Fußhebelöffnung - vordere Sackentnahme - 2 Räder.

DE Müllsackhalterung. Runder Edelstahldeckel mit Fußhebelöffnung.

	ABX-AV4652	ABX-AV4654
	49 x 50 x 101(h) cm	49 x 50 x 79(h) cm
	100 L	70 L
	580 €	530 €

	ABX-AV4681
	55 x 45 x 85(h) cm
	sacco grande / big bag
	254 €

ABX-CA1602 ABX-CA1603



- IT** Carrello portasacco con struttura a X. Disponibile con cestino e struttura verniciata (CA1602) o con comando a pedale e struttura cromata (CA 1603). Attacco rotondo - coperchio in plastica rotondo con aggancio.
- EN** Bag holder trolley with X structure. Available with basket and painted structure (CA1602) or with pedal control and chromed structure (CA 1603). Round fitting - round plastic lid with fastener.
- FR** Chariot porte-sac en forme de X. Disponible avec boîtier et structure peinte (CA1602) ou avec commande à pédale et structure chromée (CA 1603). Support rond - couvercle rond en plastique avec raccord.
- DE** Müllsackwagen mit X-Förmige Struktur. Erhältlich mit Korb und lackierter Struktur (CA1602) oder mit Fußhebelöffnung und verchromter Struktur (CA 1603). Runder Anschluss - runder Kunststoffdeckel mit Aufhängung.

	ABX-CA1602	ABX-CA1603
	58 x 56 x 102(h) cm	58 x 56 x 102(h) cm
	225 €	265 €

ABX-AV4682



- IT** Pattumierein polietilene per raccolta differenziata - Struttura colore grigio - coperchio colorato a scelta. Ruote ø 143 mm.
- EN** Polyethylene waste bins for differentiated collection - Grey structure - coloured lid of your choice. Wheels ø 143 mm.
- FR** Poubelles en polyéthylène pour collecte différenciée - Structure de couleur grise - couvercle de couleur de votre choix. Roues ø 143 mm.
- DE** Abfalleimer aus Polyethylen zur getrennten Entsorgung - graue Struktur - farbiger Deckel Ihrer Wahl. Räder ø 143 mm.

	ABX-AV4682Y giallo/yellow	ABX-AV4682R rosso/red	ABX-AV4682B blu/blue	ABX-AV4682G verde/green
	54 x 49 x 85(h) cm			
	80 L			
	61 €			

ABX-AV4674



ABX-AV4676



ABX-AV4678



ABX-AV4679



- IT Pattumiere in polietilene.
Diversi colori disponibili.
Ruote \varnothing 200 mm.
- EN Polyethylene waste bins.
Several colours available.
Wheels \varnothing 200 mm.
- FR Poubelles en polyéthylène.
Différentes couleurs disponibles.
Roues \varnothing 200 mm.
- DE Abfalleimer aus Polyethylen.
Erhältlich in verschiedenen Farben.
Räder \varnothing 200 mm.

**OPTIONAL
ABX-RC0075**

Pedale apricoperchio per contenitore
Pedal lid opener for container
Pédale ouvre-couvercle pour conteneur
Deckelöffnungsfußhebel

62 €

ABX-AV4675



i	ABX-AV4674	ABX-AV4675	ABX-AV4676	ABX-AV4678	ABX-AV4679
↗ cm	55 x 48 x 93(h) cm				
L	120 L				
	100 €				

ABX-HLA
ABX-HLE

ABX-HLC
ABX-HLF



ABX-HLECB



ABX-HLFA



ABX-HLEBD



ABX-HLEN

Lampade riscaldanti

IT Lampade riscaldanti a infrarossi a sospensione - disponibili in diverse forme come da foto, nei colori nero, argento, oro e rame.

EN Infrared hanging heating lamps - available in different shapes as shown in the picture, in black, silver, gold and copper.

FR Lampes chauffantes à infrarouge à suspension - disponibles en différentes formes comme indiqué sur la photo, en noir, argent, or et cuivre.

DE Infrarot-Heizlampen zum Aufhängen - erhältlich in verschiedenen Formen, wie auf dem Bild gezeigt, in Schwarz, Silber, Gold und Kupfer.

i	ABX-HLAN nero / black	ABX-HLAA argento / silver	ABX-HLEBD oro / gold	ABX-HLEBB rame / copper
⚡	250 W			
1 Ph	230V/50-60 HZ			
🌡️	+30° +90°C			
↗️ cm	ø 175 mm			
€	90 €	90 €	115 €	115 €

i	ABX-HLCN nero / black	ABX-HLCA argento / silver	ABX-HLECD oro / gold	ABX-HLECB rame / copper
⚡	250 W			
1 Ph	230V/50-60 HZ			
🌡️	+30° +90°C			
↗️ cm	ø 270 mm			
€	100 €	100 €	115 €	115 €

i	ABX-HLFN nero / black	ABX-HLFA argento / silver	ABX-HLEFD oro / gold	ABX-HLEFB rame / copper
⚡	250 W			
1 Ph	230V/50-60 HZ			
🌡️	+30° +90°C			
↗️ cm	ø 270 mm			
€	100 €	100 €	115 €	115 €

i	ABX-HLEN nero / black	ABX-HLEA argento / silver	ABX-HLEED oro / gold	ABX-HLEEB rame / copper
⚡	250 W			
1 Ph	230V/50-60 HZ			
🌡️	+30° +90°C			
↗️ cm	ø 290 mm			
€	100 €	100 €	115 €	115 €

ABX-SUVN
ABX-SUVN2P



ABX-SUVN2P



ABX-SUVN











**Sterilizzatori universali
a raggi UV**

IT Armadietto sterilizzatore universale a raggi UV costruito in acciaio inox con finitura Scotch Brite. Adatto per utensilerie varie - funzionamento con lampada germicida con griglia di protezione - portina in plexiglas trasparente con microinterruttore - temporizzatore 60' e lampada spia di funzionamento - cavo con spina. Disponibili ad uno o due scomparti.

EN Universal UV steriliser cabinet made of stainless steel with Scotch Brite finish. Ideal for various tools - germicidal lamp operation with protection grid - clear Plexiglas door with microswitch - 60' timer and indicator lamp - cable with plug. Available with one or two compartments.

FR Armoire stérilisateur UV universelle en acier inox avec finition Scotch Brite. Indiqué pour divers ustensiles - fonctionnement avec lampe germicide avec grille de protection - porte en plexiglas transparent avec microinterrupteur - minuteur 60' et indicateur lumineux de fonctionnement - câble avec fiche. Disponible avec une ou deux compartiment.

DE UV-Sterilisationsschrank aus Scotch Brite Edelstahl. Geeignet für verschiedene Utensilien - Funktionsweise mit keimtötender Lampe mit Schutzgitter - klare Plexiglastür mit Mikroschalter - 60'-Timer und-Anzeigelampe - Kabel mit Stecker. Erhältlich mit einem oder zwei Einlegeböden.

	ABX-SUVN	ABX-SUVN2P
	0,16 kW	0,16 x 2 kW
 1 Ph	230V/50Hz	
	510 x 280 x 350(h) mm	510 x 280 x 700(h) mm
		
 NET Kg	7,5 Kg	
 GROSS Kg	9 Kg	
	550 x 450 x 550(h) mm	680 x 400 x 900(h) mm
	0.136 m ³	0.244 m ³
	450 €	800 €

ABX-LP800

ABX-LP850

ABX-LP1000

ABX-LP1050



NUOVI COLORI DISPONIBILI
NEW COLORS AVAILABLE



ABX-LP800CA



CARBON
CHARCOAL GRAY



ABX-LP800B

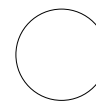

BIANCO
WHITE



ABX-LP800CE



CENERE
ASH GRAY

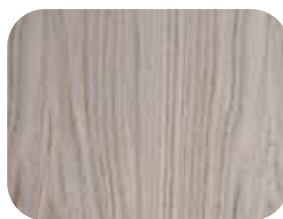

**Carrelli di servizio
in legno**









IT Carrelli di servizio in legno. Struttura in legno massello - ripiani in nobilitato di betulla - ruote multidirezionali cromate ø 100 mm. Telaio e cupola dello stesso colore acquistabile a parte e facilmente applicabile. Colorazioni a poro aperto disponibili in: bianco, cenere e carbon.

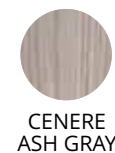

EN Wooden service trolleys. Solid wood structure - birch multi-layered wood shelves - multidirectional chrome-plated wheels ø 100 mm. Easy to assemble frame and dome in the same colour, to be separately purchased. Open pore finishes available in: white, ash and carbon.





FR Chariots de service en bois. Structure en bois massif - étagères en bouleau mélaminé - roues multidirectionnelles chromées ø 100 mm. Cadre et dôme de la même couleur vendus séparément et facilement applicables. Couleurs à pores ouverts disponibles en : blanc, cendré et carbone.



DE Servicewagen aus Holz. Struktur aus Massivholz - Ablagefläche aus Birkenfurnierholz - Mehrweg-Chromräder ø 100 mm. Gestell und Deckel der gleichen Farbe sind separat erhältlich und leicht anzubringen. Offenporige Farbgebung in den Farben: Weiß, Aschgrau und Carbon.



	ABX-LP800CA carbon/charcoal gray	ABX-LP800CE cenere/ash gray	ABX-LP800B bianco/white	ABX-LP850CA carbon/charcoal gray	ABX-LP850CE cenere/ash gray	ABX-LP850B bianco/white
	81 x 55 x 108(h) cm					
	2			3		
	80 Kg					
	930 €			1.110 €		

	TELAIO + CUPOLA / FRAME + DOME / GESTELL + DECKEL / CADRE + DÔME		
	ABX-A1236 for model LP800/850CA	ABX-A1237 for model LP800/850CE	ABX-A1238 for model LP800/850B
	70 x 50 x 22(h) cm		
	470 €		

	ABX-LP1000CA carbon/charcoal gray	ABX-LP1000CE cenere/ash gray	ABX-LP1000B bianco/white	ABX-LP1050CA carbon/charcoal gray	ABX-LP1050CE cenere/ash gray	ABX-LP1050B bianco/white
	115 x 55 x 108(h) cm					
	2			3		
	80 Kg					
	975 €			1.160 €		

	TELAIO + CUPOLA / FRAME + DOME / GESTELL + DECKEL / CADRE + DÔME		
	ABX-A1233 for model LP1000/1050CA	ABX-A1234 for model LP1000/1050CE	ABX-A1235 for model LP1000/1050B
	90 x 50 x 22(h) cm		
	520 €		

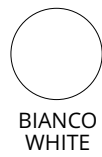

ABX-A1235



ABX-A1234



ABX-ML3202SS
ABX-ML3204SS



NUOVI COLORI DISPONIBILI
NEW COLORS AVAILABLE



ABX-ML3202SS



ABX-ML3202SSCA



CARBON
CHARCOAL GRAY



ABX-ML3204SSCE

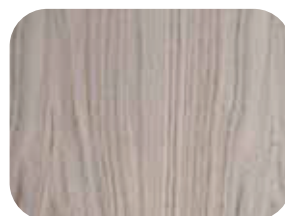

CENERE
ASH GRAY



Mobili di servizio
in legno

IT Mobili di servizio in legno. Mobili di servizio bassi doppi - struttura e pannelli in nobilitato - 2 cassetti portaposate di cui 1 con separatore - 2 sportelli - ruote multidirezionali ø 50 mm. Colorazioni a poro aperto disponibili in: cenere e carbon.

EN Wooden service cabinets. Low double service cabinets - melamine structure and panels - 2 cutlery drawers, 1 with separator - 2 doors - multidirectional wheels ø 50 mm. Open pore finishes available in: ash and carbon.

FR Meubles de service en bois. Meubles bas de service double - structure et panneaux en mélaminé - 2 tiroirs à couverts dont 1 avec séparateur - 2 portes - roues multidirectionnelles ø 50 mm. Couleurs à pores ouverts disponibles en : cendré et carbone.

DE Servicemöbel aus Holz. Niedrige Doppelservicemöbel - Struktur und Blenden aus Melamin - 2 Besteckschubladen, davon 1 mit Trennwand - 2 Türen - Mehrwegräder ø 50 mm. Offenporige Farbgebung in den Farben: Aschgrau und Carbon.

	ABX-ML3202SSCA carbon/charcoal gray	ABX-ML3202SSCE cenere/ash gray
		
	90 x 48 x 95(h) cm	
	2 sportelli - 2 cassetti 2 doors - 2 drawers	
	1.255 €	



CARBON
CHARCOAL GRAY





CENERE
ASH GRAY

IT Mobili di servizio bassi tripli - struttura e pannelli in nobilitato - 3 cassetti portaposate di cui 2 con separatore - 2 sportelli - 1 vano interno - ruote multidirezionali ø 50 mm. Colorazioni a poro aperto disponibili in: cenere e carbon.

EN Low triple service cabinets - melamine structure and panels - 3 cutlery drawers, 2 with separator - 2 doors - 1 internal compartment - multidirectional wheels ø 50 mm. Open pore finishes available in: ash and carbon.

FR Meubles bas de service triple - structure et panneaux mélaminés - 3 tiroirs à couverts, dont 2 avec séparateur - 2 portes - 1 compartiment intérieur - roues multidirectionnelles ø 50 mm. Couleurs à pores ouverts disponibles en : cendré et carbone.

DE Niedrige Trippelservicemöbel - Struktur und Blenden aus Melamin - 3 Besteckschubladen, davon 2 mit Trennwand - 2 Türen - 1 Innenfach - Mehrwegräder ø 50 mm. Offenporige Farbgebung in den Farben: Aschgrau und Carbon.

	ABX-ML3204SSCA carbon/charcoal gray	ABX-ML3204SSCE cenere/ash gray
		
	136 x 48 x 95(h) cm	
	2 sportelli - 3 cassetti - 1 vano interno 2 doors - 3 drawers - 1 internal compartment	
	1.640 €	



CARBON
CHARCOAL GRAY

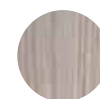

CENERE
ASH GRAY



Scarica il catalogo completo



Cataloghi digitali, alberi felici:
scegli **Abintrax** che con **mydidactstore**,
abbraccia la sostenibilità!

Concessionario

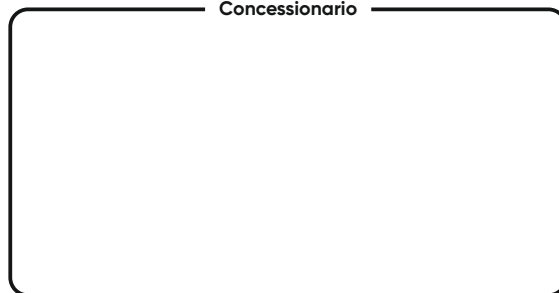

Abintrax s.r.l.

Via Marina del Mondo, 62 | 70043 Monopoli (Ba) Italy
tel. +39 080 2149700 | www.abintrax.com | info@abintrax.com

www.mydidactstore.it