



Ingegneria Elettrica Elettronica Tecnologie Digitali

Strumenti di apprendimento dei principi di base

ETS DIDACTIC



ELECTRICAL ENGINEERING / ELECTRONICS DIGITAL TECHNOLOGY

The basics in detail

Visita il nostro store



another way to care

www.mydidactstore.it

 **Didact**
STORE

PrincipLES of ELEc Trical EnginEERING
analysis of electrical-engineering systems on component level

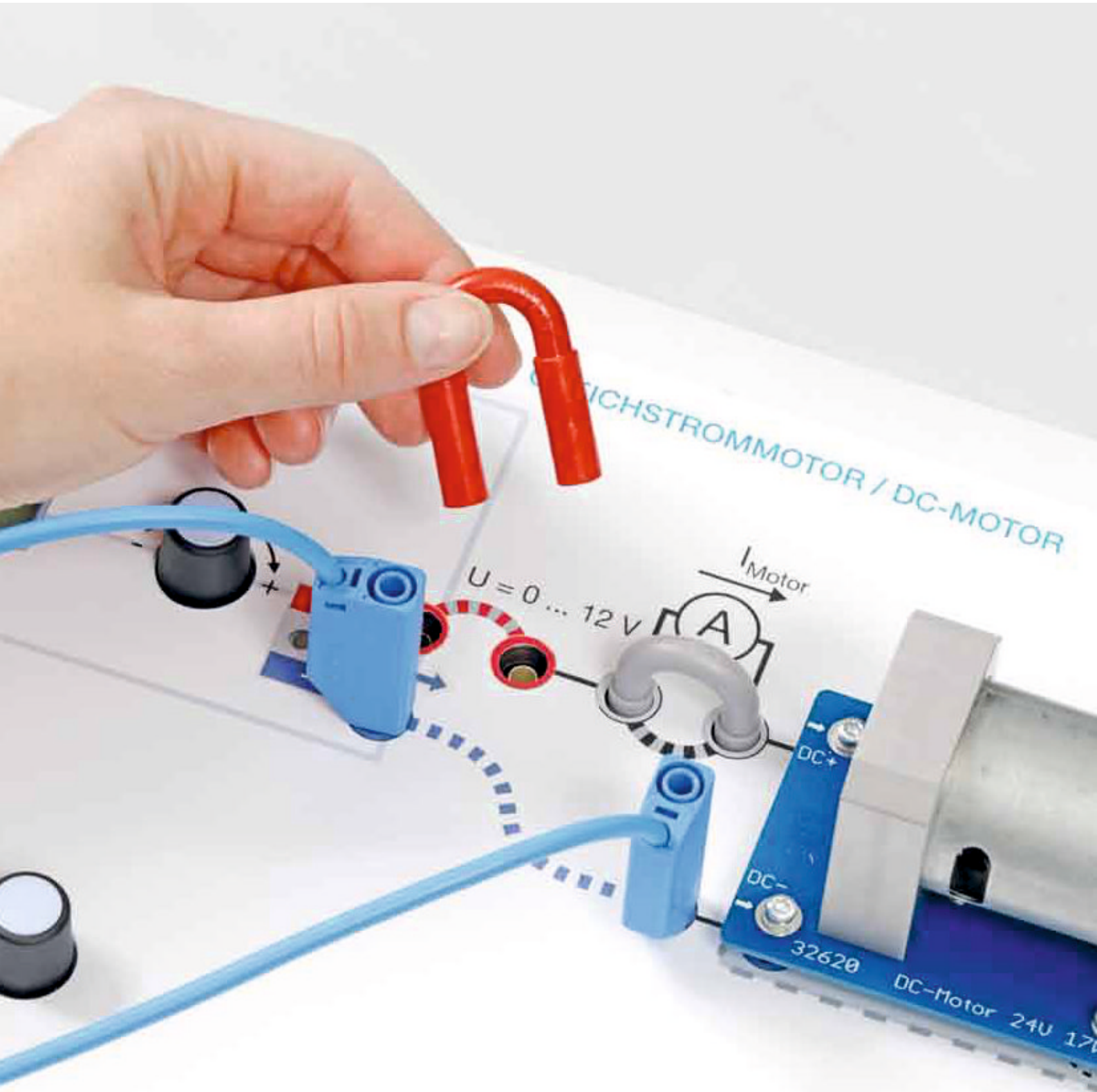

conTEntS

Electrical engineering/Electronics/Digital technology

General Information

Editorial	4
Visit ETs in the Valley of river altmühl.....	6
approach and room concept.....	8
People and Technology.....	10
Workshops with ETs	12
The ETs Training concept	14

Electrical engineering/Electronics

hardware	16
Electrical engineering/Electronics.....	20
component set electronics.....	22
Plug-in components	24
overview of the individual components.....	26
Dc motor 24V 17W and three-phase synchronous motor ac3 10V.....	28
Direct current technology – courseware	30
Measurement technology	32
accessories.....	34
Electrical engineering.....	36
Didactic overlay masks.....	42
automotive electrical.....	42
Fundamentals of electrical engineering – courseware	44

Automotive electrics/electronics

automotive electrical engineering.....	48
Basics of automotive electrics/electronics.....	50
Basics of automotive electrics – case	52
Universal solutions.....	54
Training concept electrical engineering – MEDia-T3 BoxX	56
chemistry/electrochemistry – courseware.....	58
Transformers – courseware	60

Digital technology

hardware	64
Basic digital technology	66
Basic digital technology trainer – overlay mask	70
µ-Trainer	72
Fundamentals and basic circuits of digital technology – courseware	73
Modules	74
Mobile systems.....	80
Measuring devices.....	82

Information and Consultation

s tay connected – with us on social Media.....	84
Quality is the Measure of all success	86
Please contact us	88
your Enquiry	90



PEoPLE anD TEchnoL ogy – a PErFEc T MaTch

Technology to inspire you: understanding – comprehending – applying

ETS DIDACTIC is your partner for in-house and institutional education and training in the professional fields of electrical engineering and metal technology.

Topics such as industry 4.0, electrical engineering, power electronics, pneumatics, drive technology, automation technology, sensor technology, bus systems, mechatronics, transmission technology and the complete scope of building systems engineering including renewable energies are presented as a training system. With the help of well thought-out learning-oriented hardware and accompanying courseware, the specialist skills are quickly learned, grasped by hands and lead to didactic learning success in a goal-oriented manner.

The service spectrum of ETS DIDACTIC ranges from the provision of didactic hardware, courseware and software to the planning and equipping of the complete training rooms. ETS meets all requirements with practice-oriented workshops on the complete spectrum of technical professions for lecturers, trainers and instructors in a specially built modern training center or online.

Vocational schools, training centres of the ICC, chamber of crafts or the industry, polytechnics and universities are among the long-standing customers of ETS DIDACTIC.



Welcome to ETS DiDac Tic

ETS DIDACTIC is the pioneer and market leader in the development, manufacture and sales of electrical, automation and mechatronic workstations for training and instruction.

ETS DIDACTIC counts among the leading international manufacturers in the market environment. Located in Kinding, in the beautiful natural reserve of altmühlal – high-quality products and solutions are developed and manufactured for you.

in the training centre in Kinding, the focus is on the practical application of the systems and fast learning of new technologies by the customers.

The knowledge, experience and the above-average personal involvement of the motivated employees of ETS DIDACTIC are vital factors for the company's efficiency.



Sven Urban
Managing Director



Udo Urban
Managing Director
(Founder)



MaDE in gErMany

Visit ETs in the Valley of river altmühl

Welcome to Germany - Bavaria

The altmühltal nature Park is one of the largest in Germany and offers a thousand ideas for families, history fans, cultural discoverers and nature lovers.

You can travel to our workshop in Kinding-haunstetten by train. The regional train station Kinding/Altmühltal is located directly on the ICE route between Nuremberg and Munich. The regional express trains of Deutsche Bahn stop every two hours. The journey from Kinding to Ingolstadt takes 17 minutes, to Munich 1 hour 15 minutes and to Nuremberg only 27 minutes.

Local cab companies are available to take you from Kinding to Haunstetten. We will be happy to assist you with the organization.

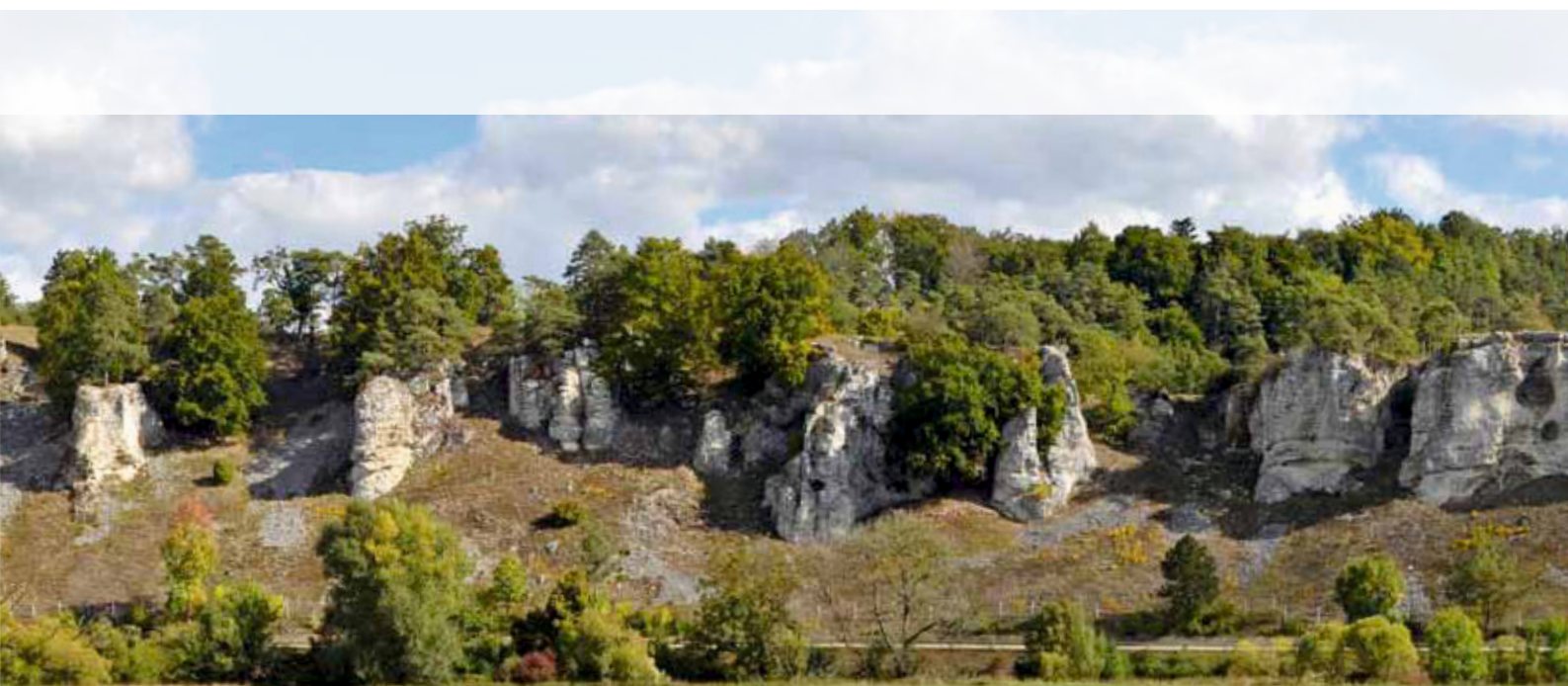
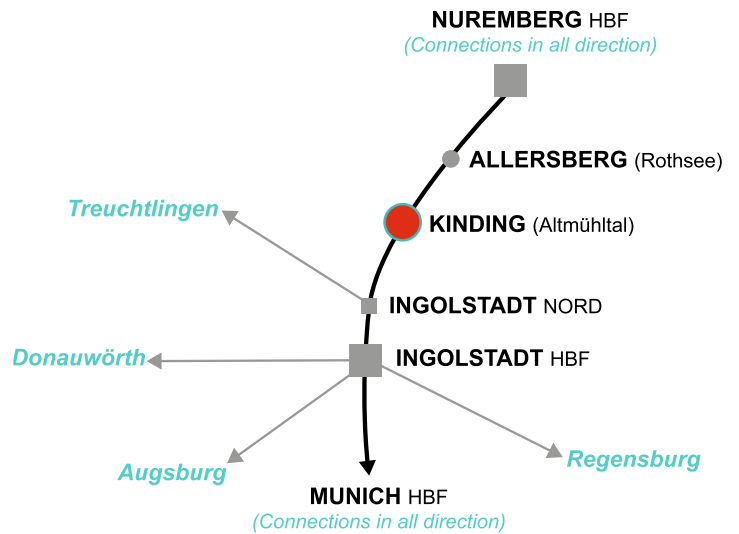

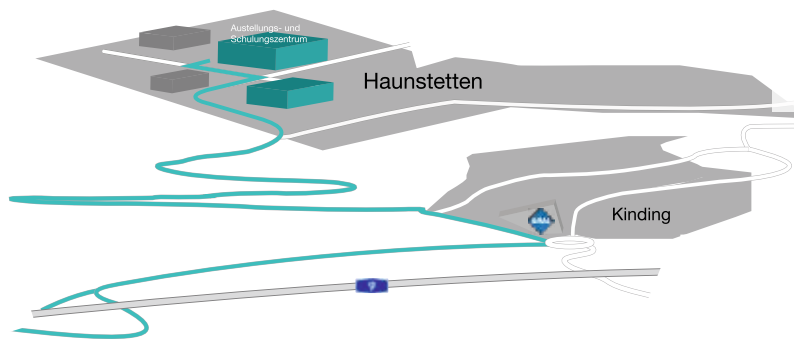

Kloster Weltenburg



naturpark altmühltal



aPProach anD rooM concEPT

To plan a custom-made room concept with you, we proceed in the following steps:

- › a good room concept is based on professional advice. The technical consultants of ETs DiDac Tic are pleased to support you in the local planning phase. Benefit from their technical expertise and experience.
- › Planning a room concept is more than selecting the furniture. Each room concept is adapted and developed for the local requirements of the customer.
- › Taking into account the learning contents an equipment list can be set up. as soon as the extent is defined, the storage equipment is optimised and designed.



analysis

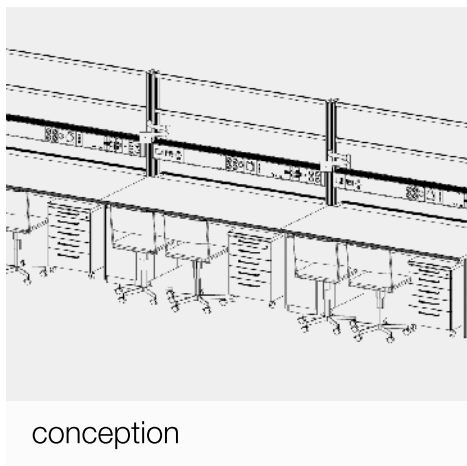

conception



consulting / Planning

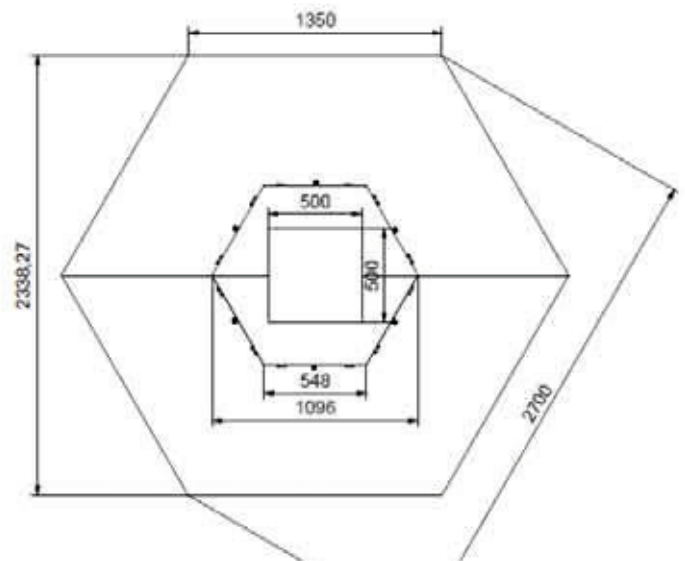

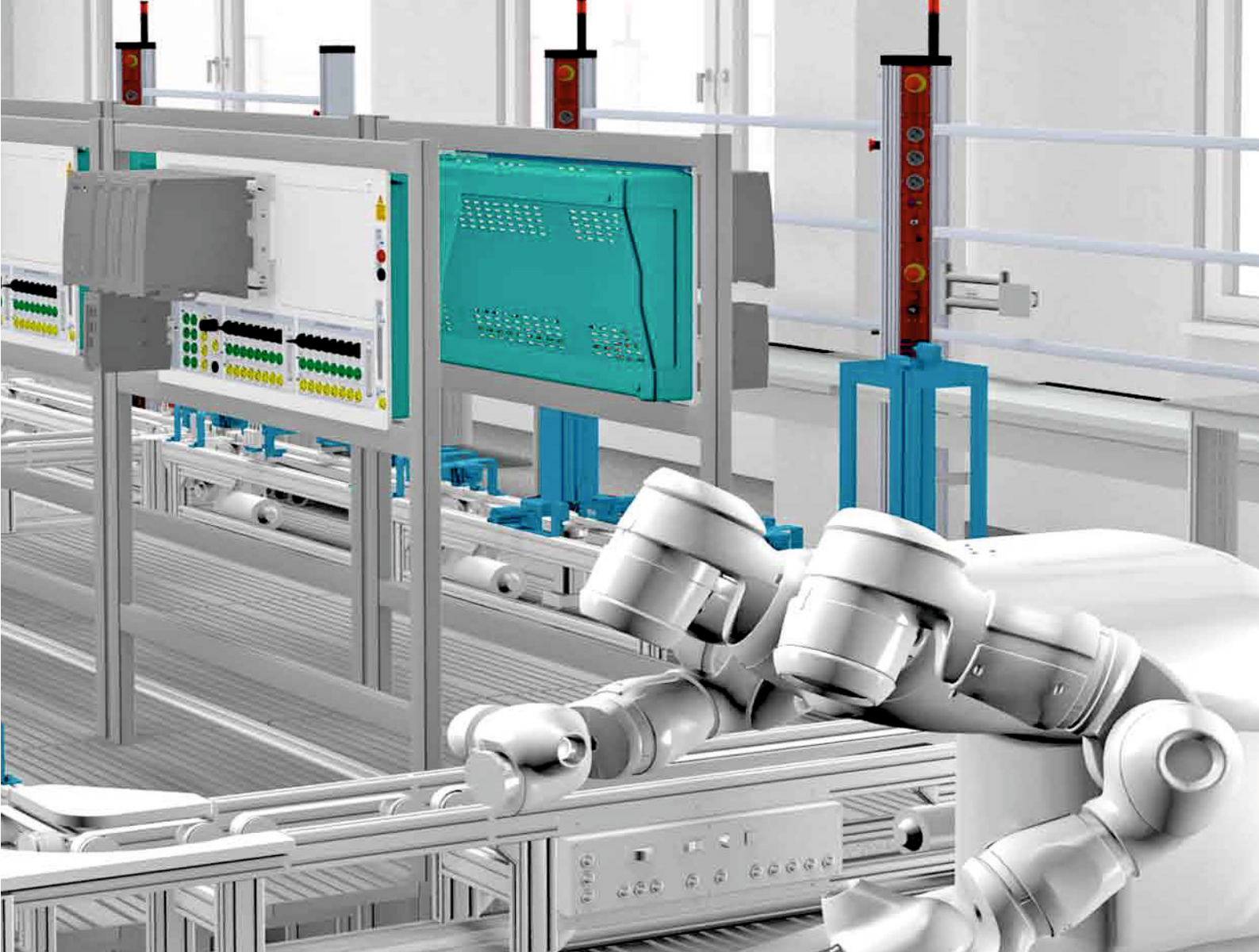

Design / construction

Workshops

application



PEoPLE and TEchnoL ogy – a PErFEc T MaTch

Didactic and Technology result in the ET s-concept



compact Boards

- › Their didactical concept makes our training systems in a4 format outstanding.
- › The photorealistic design of their front panels with graphics, pictures, connection details or warning messages assist and guide the experiments - cognitive didactics. Due to the graphics, users comprehend and remember the technologies more easily.
- › The systems can be mounted in an a4 frame or placed directly on a table.

Experimental Boxes

- › construct your own experiments. Beside the wiring, the arrangement of the components is focused. With the experimental boxes it's possible to practice basic circuits as well as complex installations
- › always close to practice, fast and safe!
- › Wide range of industrial components.

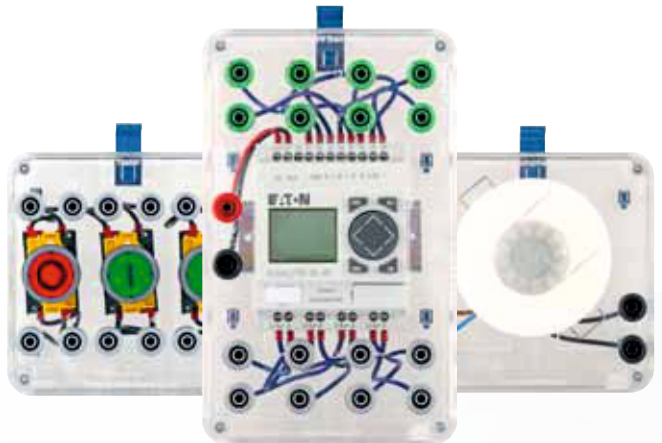

BsT®-Buildings systemsTrainer

- › The Buildings systemsTrainer® is a mobile training system that can be taken from one classroom to another and then is ready for use within some minutes.
- › Beside our laboratory equipment with the experimental boards, these flexible training systems represent an independent product line covering many topics as e.g. the VDE protective measures according to VDE 0100 or the KNX building communication sector, communications technology and renewable energies, smartBuilding and internet-of-things.
- › Boards can also be integrated in the Buildings systemsTrainer®



Workshops With ETs

always up to Date – Training at the highest Level



› Train the Trainer – workshops for teachers, trainers and lecturers in the field of electrical engineering, mechatronics and metal technology.

› Learn more about the management and the application of various technologies with the support of the ETs trainers. Find out more about the didactic concept and learn to teach the material quickly and safe.

› ETS offers a perfect seminar for all groups of products and topics of technical education. scan the Qr code to subscribe in a workshop:



<https://ets-didactic.de/hp584/Workshops.htm>



Fast and safe into new Technologies

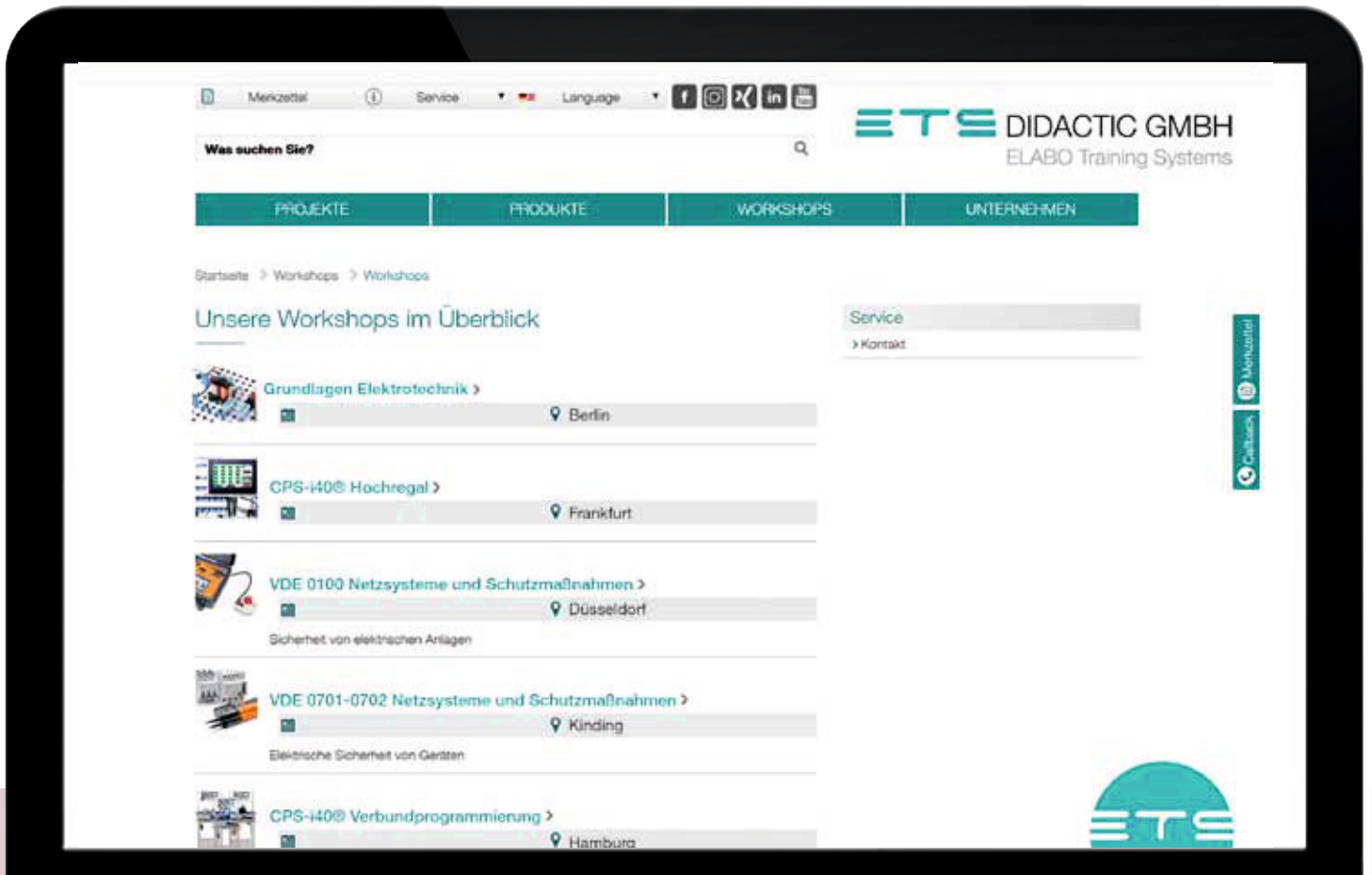

ThE ET s Training concEPT

innovative hardware / Perfect courseware

- structure of the Manuals
- › ringbinder principle
 - › Dividers
 - › incorporation of personal documents



compact

- TechnoCards[®]
- › Depiction of the parameters in function groups
 - › start-up instructions
 - › safety functions
 - › individual learning help

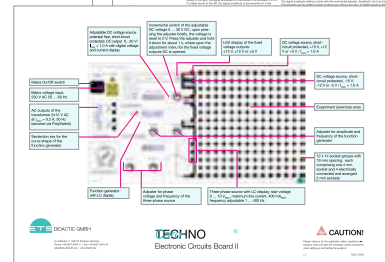
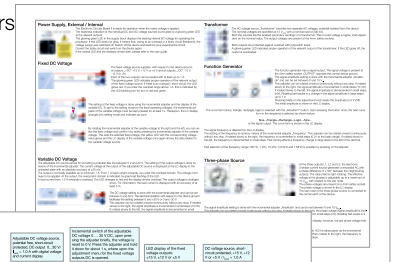

close to practice

- instructor's Edition / s tudent Edition
- › 100 % function guarantee
 - › high print quality
 - › Digital and on paper
 - › original photographs with practical references
 - › Detailed work instructions

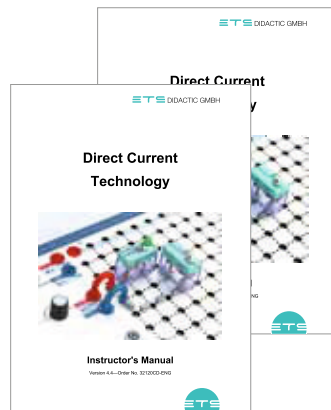

motivating

- simulations software
- › accompanying the courseware
 - › Function simulation
 - › combination of theory and practice

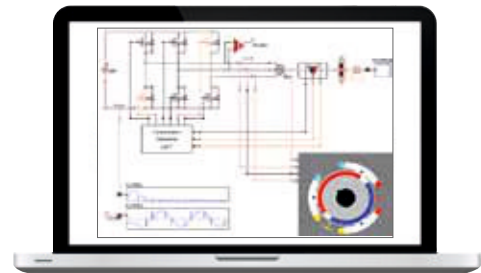

multimedia

- Front panel overlays
- › contents reduced to main focus of the experiment
 - › clear layout
 - › Basic function
 - › Various languages



efficient

- Furniture
- › Technically matched conception
 - › Excellent functionality
 - › Ergonomics at the workplace
 - › outstanding design



ergonomics

... the system for the basic electrics, electronics and digital technology

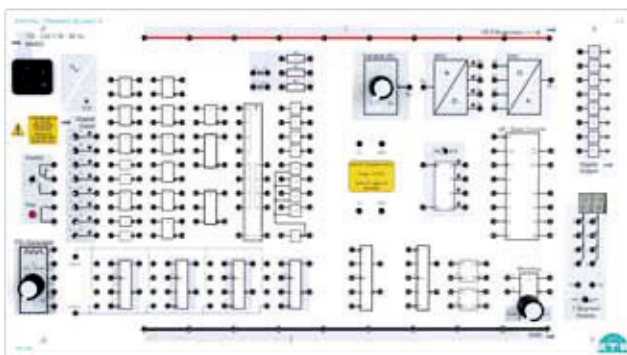
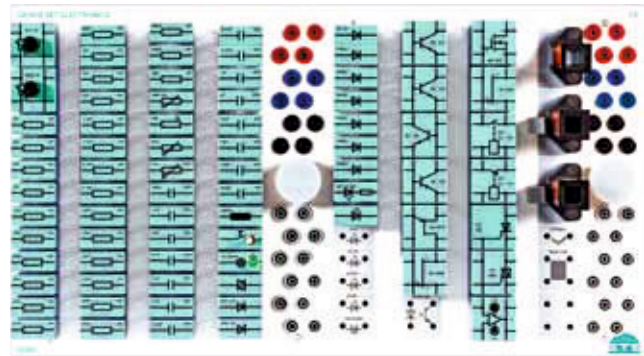
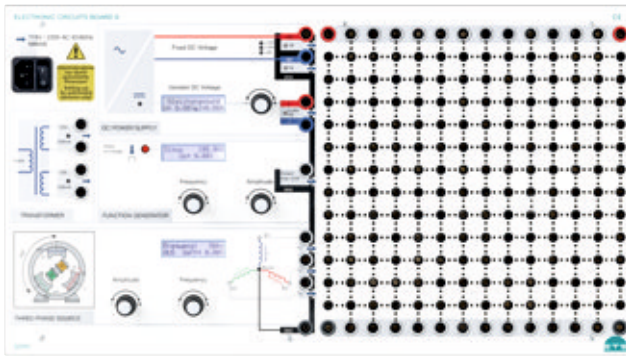

- › state-of-the-art technology
- › Easy to operate
- › Didactically prepared courseware
- › safety for people and machine
- › Perfect ergonomic workplaces



harDW arE

Electronics

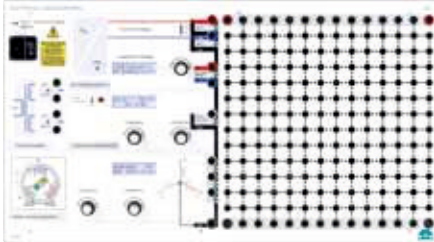

Electronics

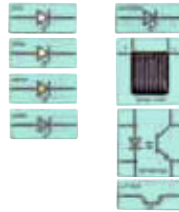

Electronics component set
opto-Electronics

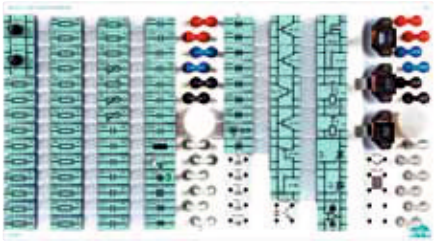

Electronics component set

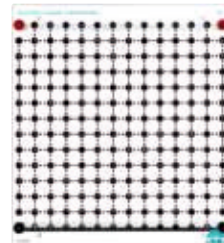

Plug-in field electronics

Measuring devices



color digital oscilloscope 30 Mhz



analog multimeter



Digital multimeter

Electrical engineering

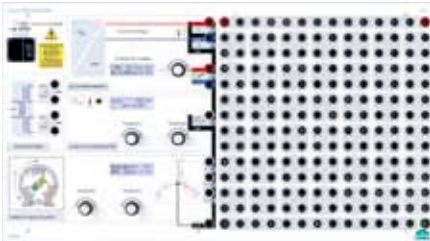

Electrics / Electrical engineering / automotive



Electrical engineering kit

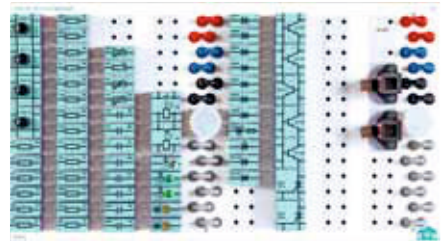

component set automotive / automotive

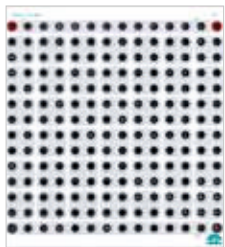

Plug-in field electrics / electrical engineering / Automotive



Universal power supply

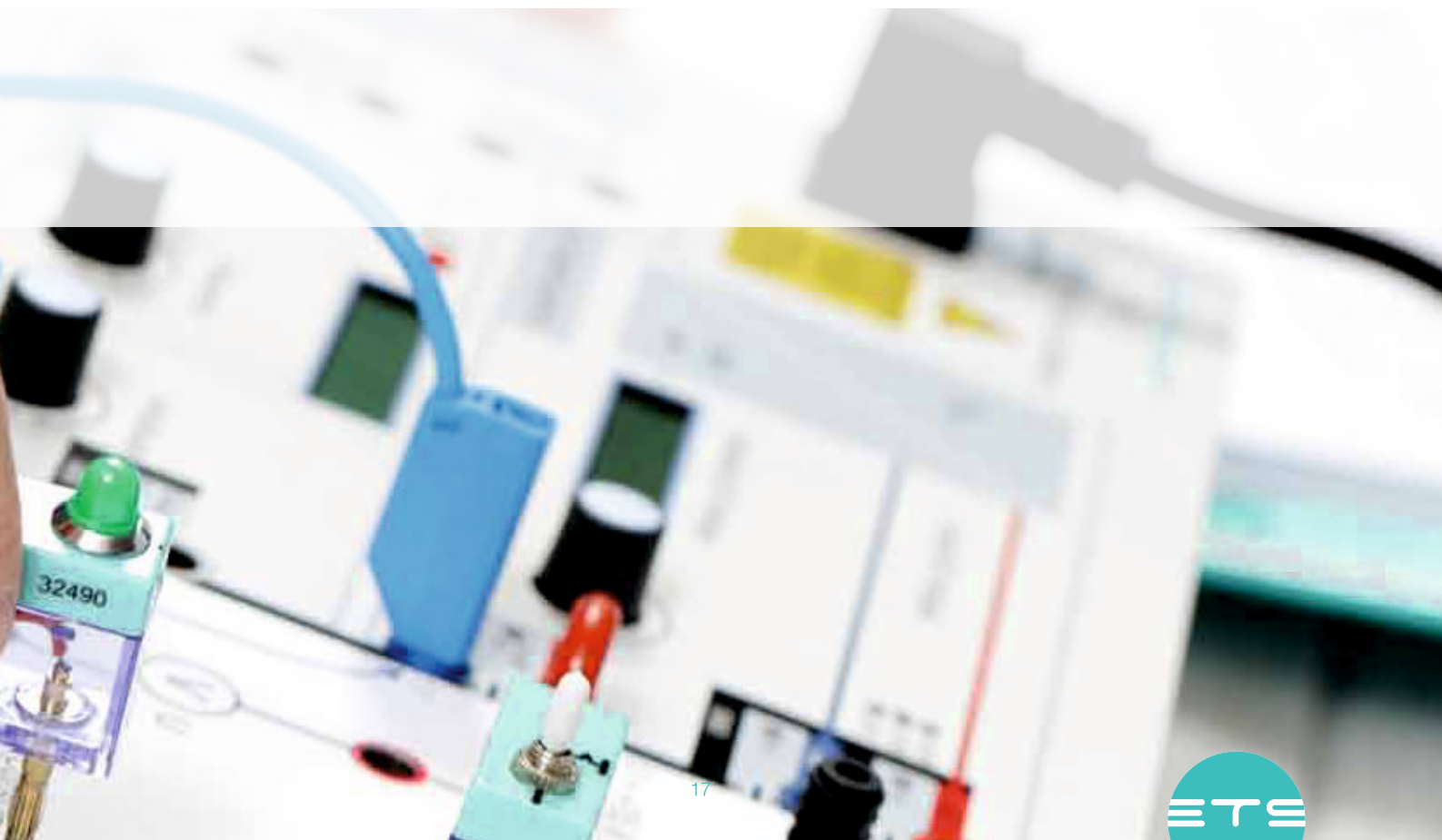

aTTrac TiVE, PoWErFUL anD saFE

Functions and operating elements

Transformer

- > ac voltage sources
- 2 x 12 V AC / 2.2 A; 50 Hz (Main frequency) fused via Polyswitch

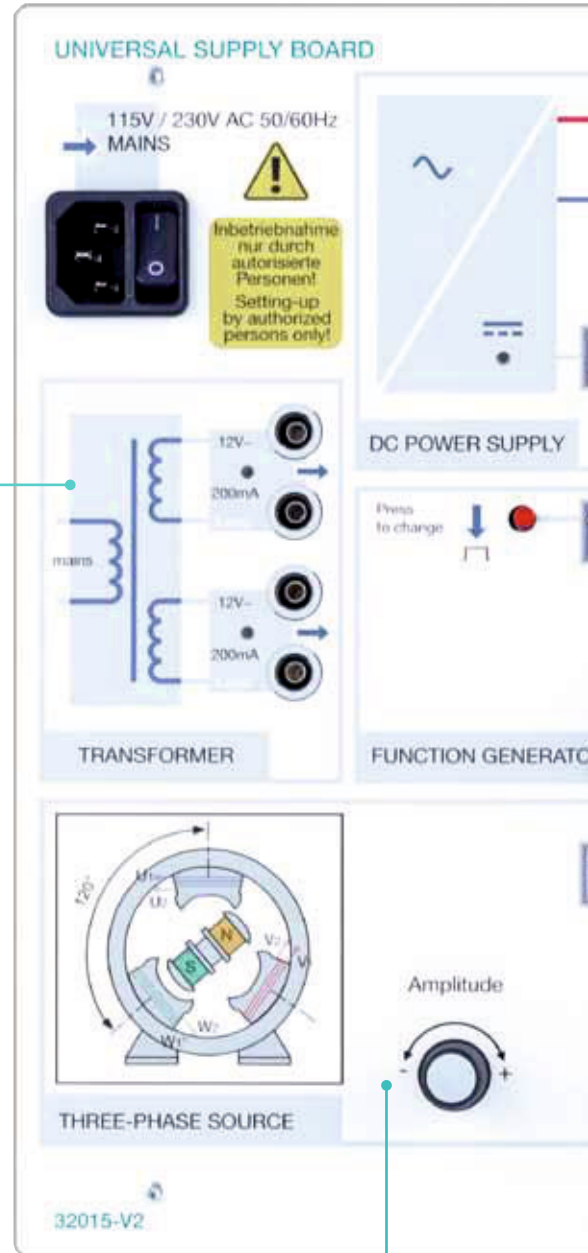
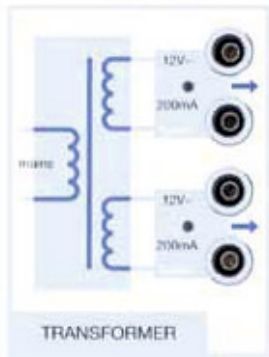

Three-phase generator

- > Frequency: 1...400 Hz, adjustable in 1 hz steps
- > conductor voltage: 0...17.3 V_{eff}
- > conductor current: max. 400 mA_{eff}
- > Display of the sizes in the LCD display
- > short-circuit and regenerative proof up to 40 V DC / 24 V AC



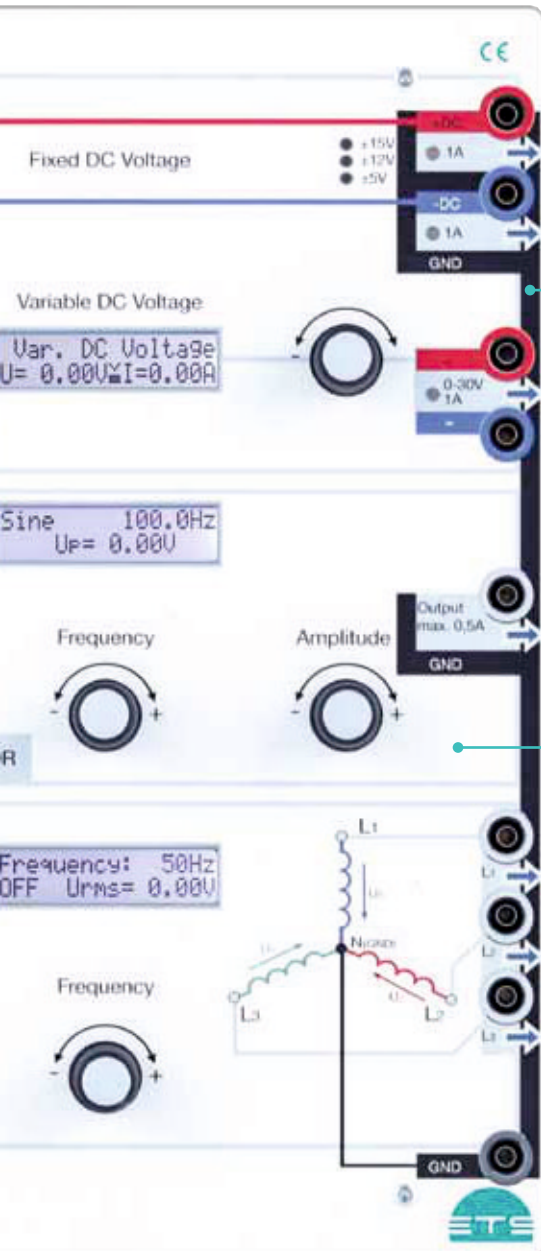

32015 Universal supply Board

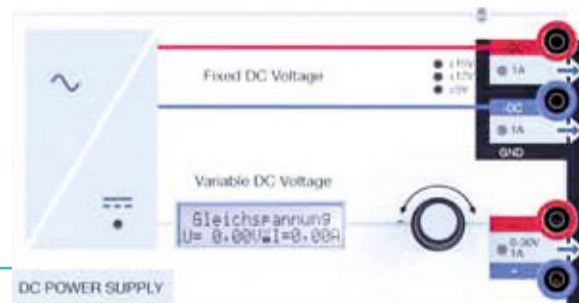

DC Power Supply

- › adjustable Dc power supply, potential-free, 0...30 V / 1.0 A with voltage and current display as well as active current limiting for safe experimentation
- › Dc voltage source, adjustable, +15 V, +12 V oder +5 V / 1.0 A
- › Dc voltage source, adjustable, -15 V, -12 V oder -5 V / 1.0 A
- › all outputs short-circuits and regenerative proof up to 40 V DC / 24 V AC, 40 W
- › overload indication via volored LED at output

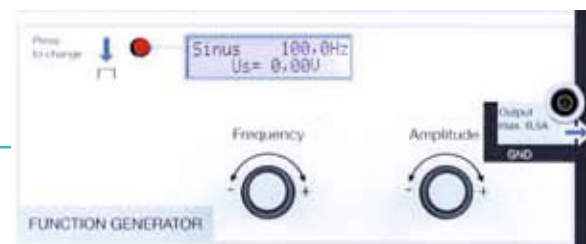

Function generator

- › LCD display with all quantities
- › Frequency: 0.1 Hz...1 MHz
- › adjuster for amplitude 0...15 V_s, setting accuracy 10 mV
- › maximum current load 0.5 A (peak current)
- › source resistance 15 Ω
- › Waveforms: sine, triangle, rectangle and logic

ELEc Trical EnginEERING/ELEc Tronics

Electronic Board

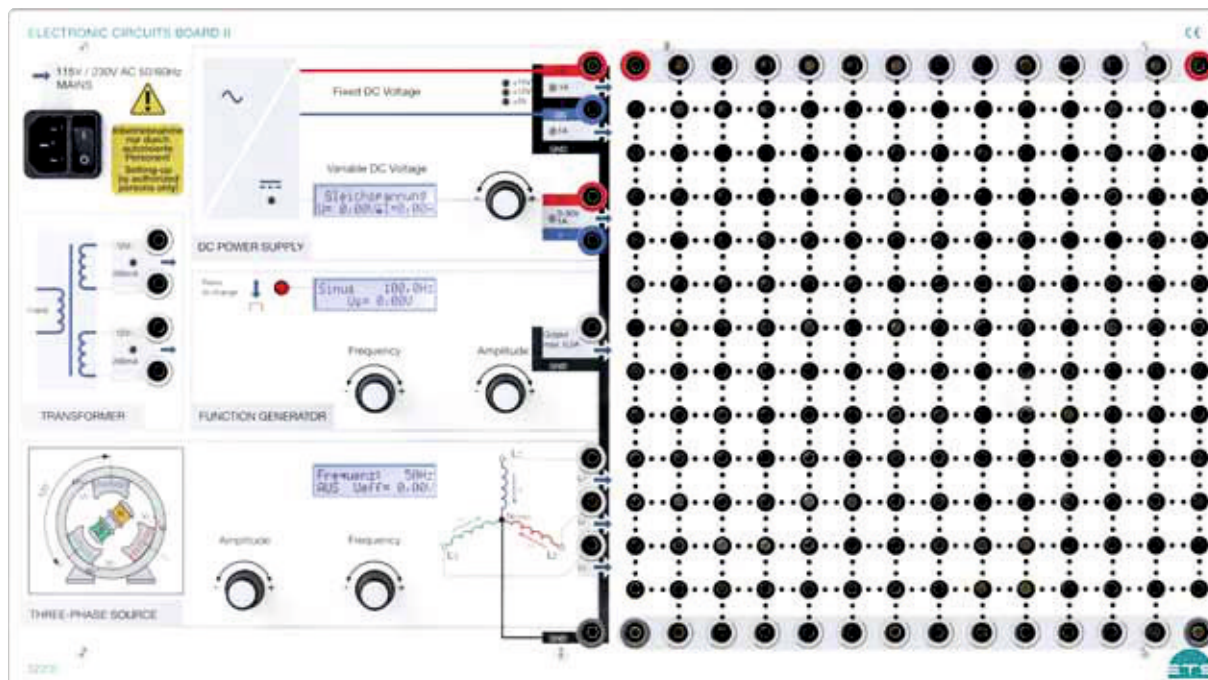

1

Learning objectives

- › Basic law of electrical engineering
- › handling and measuring with oscilloscope, multimeter and function generator
- › Direct, alternating and three-phase current technology
- › Operational amplifier
- › Voltage-, temperature- and light-dependent resistors
- › Behavior of semiconductors: Diodes, transistors, Thyristors
- › circuits of electronics: amplifiers, flip-flop circuits, power supply circuits

Technical data

- › Voltage sources Dc +/- 15 V or +/- 12 V or +/- 5 V/1 a; Dc 0...30 V/ max. 1 a with voltage and current; ac 2 x 12 V/0.2 a (fused via Polyswitch)
- › Function generator Frequency 0.1 Hz...1 Mhz, amplitude 0...15 Vs and waveform adjustable, display of all quantities
- › Three-phase generator Phase voltage 0...10 V (rms.); conductor voltage 0...17.3 V (rms.); frequency 1...400 Hz adjustable, display of all quantities, current load per phas max. 400 ma (rms.)

- › Experiment panel 4 mm safety sockets, arranged in 19 mm grid, surrounded by 4 2 mm sockets each
- › Main connection 230 V ac; 50 Hz; 75 W; protection class I
- › power supply outputs short-circuit- and regenerative-proof up to 40 V Dc/ 24 V ac, 40 W



No.	Designation	Order No.
1	Electronic circuits Board ii	32200
n.ill.*	Electronic circuits Board ii with component set 32202 installed in case	32200-V2-Z03

* For more information, see page 80.

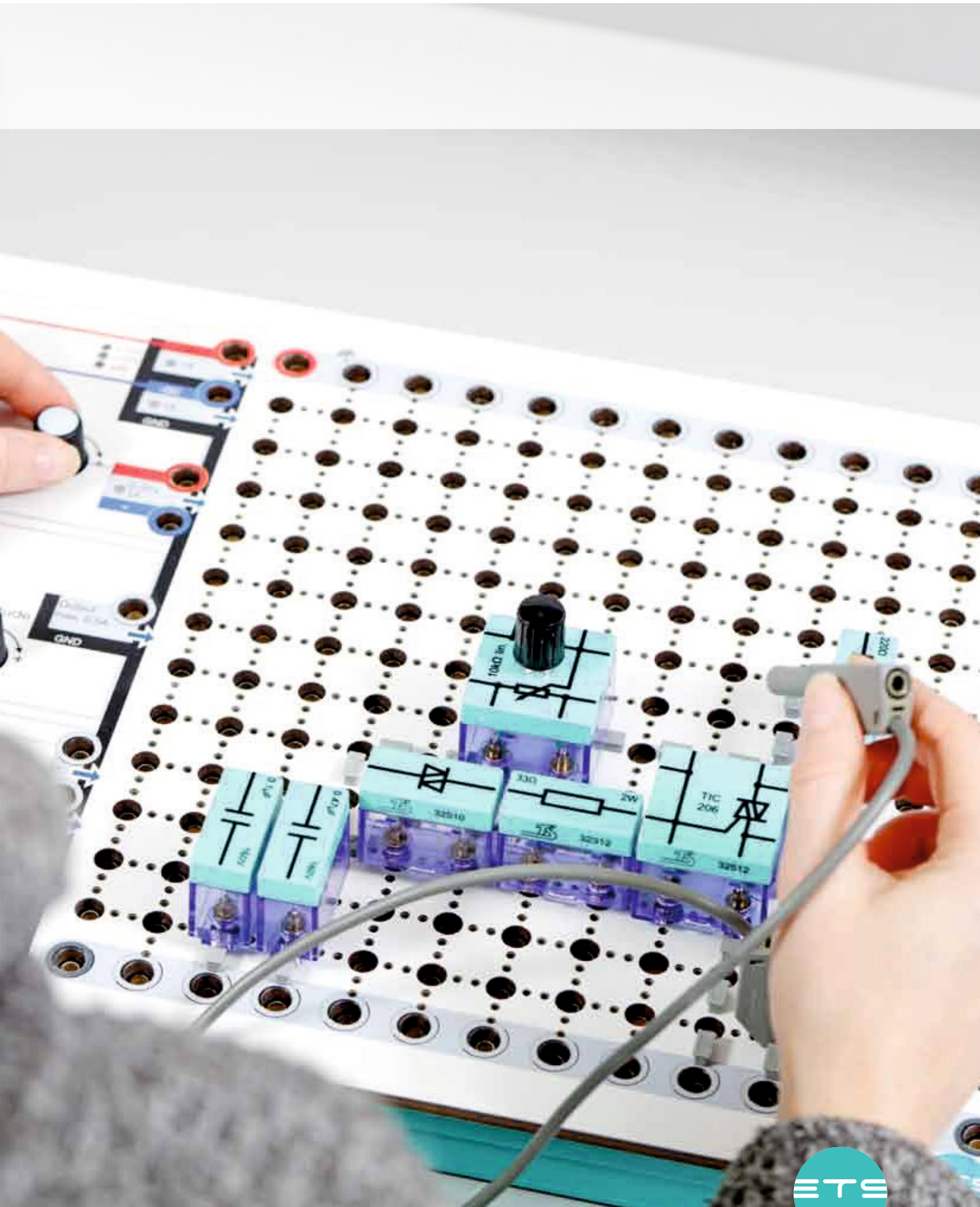

component set electronics

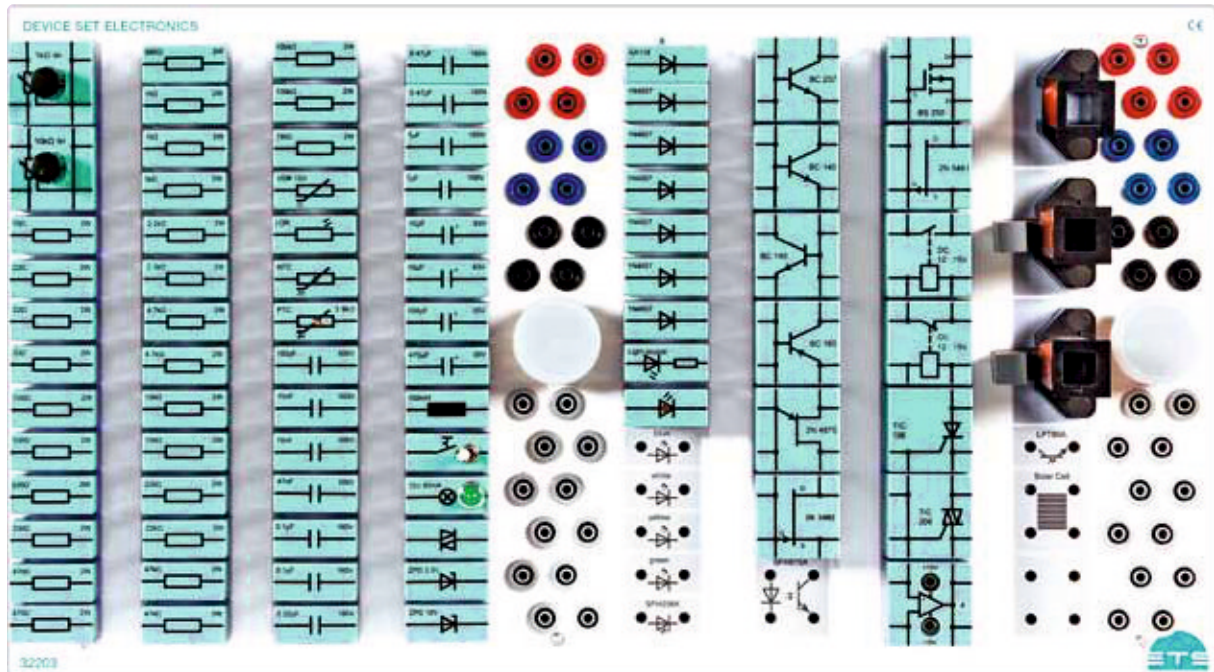

... for the sake of order

The storage plates for pluggable components are printed with the corresponding symbols.

1

Set of accessories, plugged on imprinted Storage Board:

- > 28 film resistors
10 Ω...1 MΩ
- > 1 VDr resistor
- > 1 LDr resistor
- > 1 PTC resistor
- > 1 nTc resistor
- > 11 capacitors
100 pF...1 μF
- > 4 electrolytic capacitors
10 μF...470 μF
- > 1 potentiometer linear 1 kΩ,
0.5 W
- > 1 potentiometer linear 10 kΩ,
0.5 W
- > 1 transformer coil n = 300
- > 2 transformer coils n = 900
- > 1 cut band core (1 Paar)
- > 1 coil 100mh
- > 1 transistor nPn Bc 237,
base left
- > 1 transistor nPn Bc 140,
base left
- > 1 transistor nPn Bc 140,
base right
- > 1 transistor PnP Bc 160,
base left
- > 1 unijunction transistor
Pn 2n4870
- > 1 D-MOS field effect transistor
Bs 250, P-channel
- > 1 junction field effect transistor
2n 5485, n-channel
- > 1 junction field effect transistor
2n 5461, P-channel
- > 1 diac, Er 900
- > 1 thyristor, Tic 106
- > 1 triac, Tic 206
- > 1 toggle switch
- > 1 lamp, 15 V
- > 1 light source
- > 1 operational amplifier
- > 1 ga-as light-emitting
diode, red
- > 1 ge diode aa118
- > 6 si diode 1n4007
- > 1 Zener diode ZPD 3.3 V
- > 1 Zener diode ZPD 10 V
- > 1 relay Dc 12...15 normally
open contact
- > 1 relay Dc 12...15
nc contact

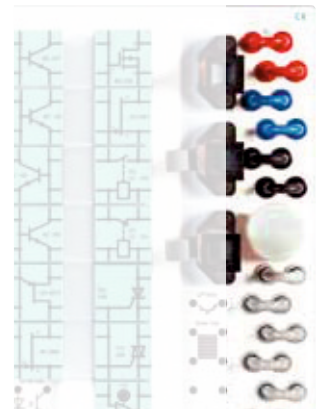

... with the possibility for the storage of jumper plugs with and without safety insulation.

No.	Designation	Order No.
1	Device set Electronics	32203

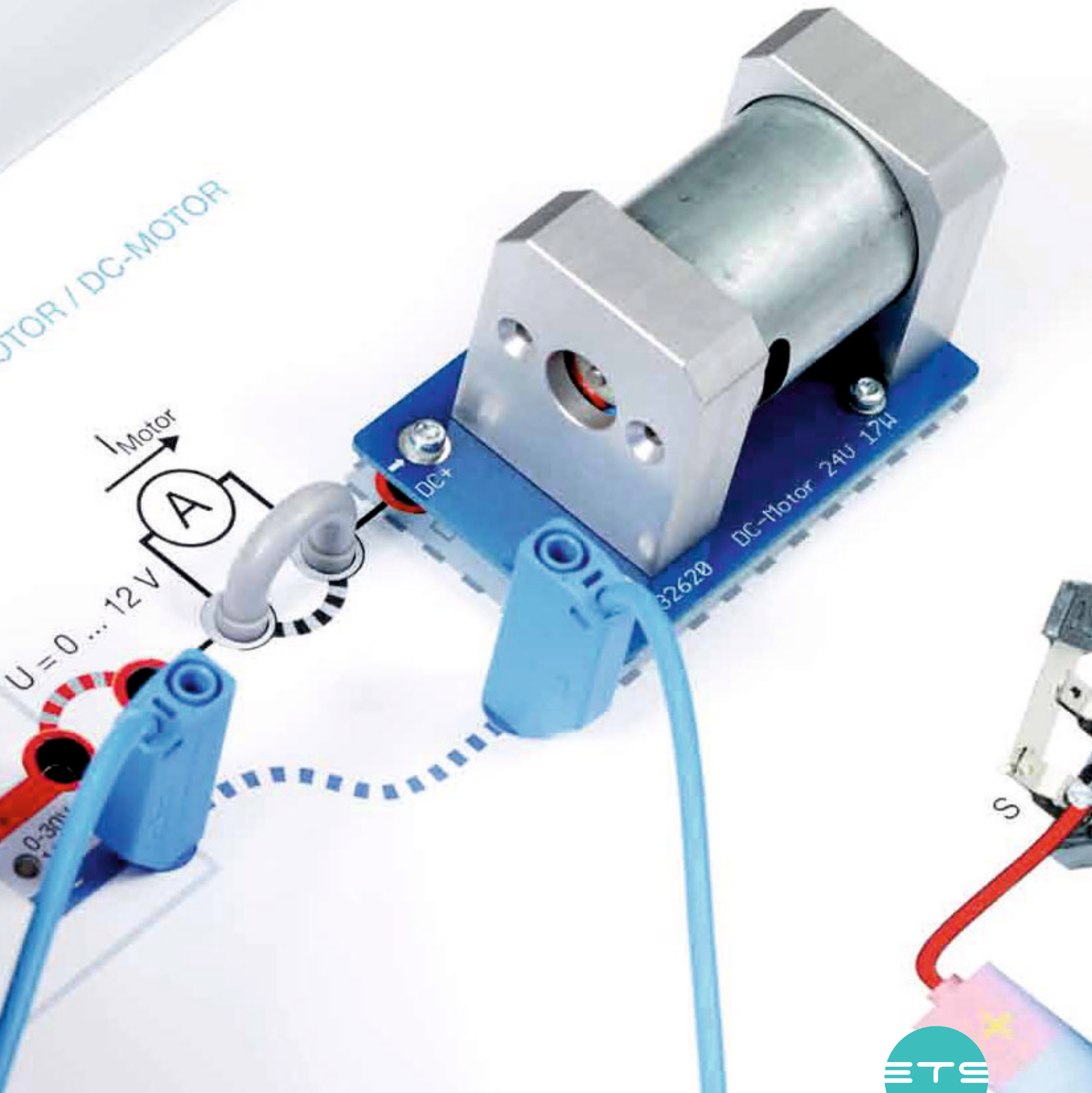

PLUG-in coMPonEnTs

Passive and active components



Resistors

- › Series E12, 1 Ω ... 10 M Ω /2 W
(1.0 1.2 1.5 1.8 2.2 2.7 3.3 3.9 4.7 5.6 6.8 8.2)

Potentiometers

- › Linear, 470 Ω , 1 k Ω , 4.7 k Ω , 10 k Ω , 47 k Ω , 0.5 W

Non-linear resistors

- › VDr-, LDr-, nTc-, PTC resistors

Capacitors

- › Series E6, 10 pF ... 1 μ F
(1.0 1.5 2.2 3.3 4.7 6.8)

Electrolytic capacitors

- › values: 10 μ F, 100 μ F, 470 μ F

Coils

- › 100 mH
- › Transformer coils with 300 / 900 windings

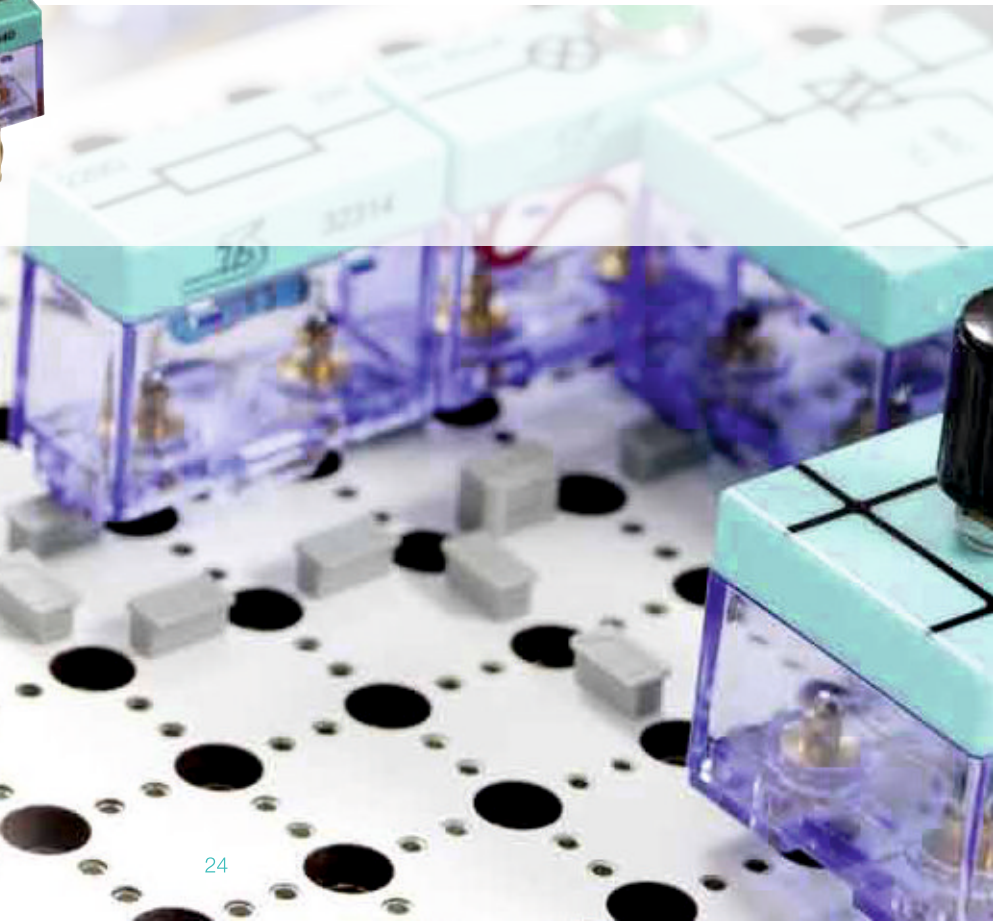

Semiconductor components

- › germanium and silicon diodes
- › nPn and PnP transistors
- › Pn unijunction transistor
- › D-MOS field effect transistor
- › Junction field effect transistor, N- and P-channel
- › Diac, thyristor, triac, igBT
- › Operational amplifier
- › Zener diode ZPD
values: 3.3 V, 10 V
- › Photo diode, photo transistor
- › LEDs in red, green, yellow, blue, white

Switching and display components

- › switch, pushbutton, relays
- › Lamp

Other

- › Empty housing, with two and four pins

Optoelectronics

- › Device set optoelectronics 32 104
(to complement device set 32 203)
- › Photo transistor, photo diode
- › optical coupler, solar cell
- › LEDs

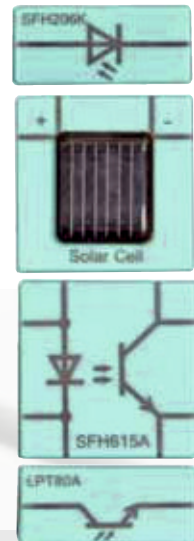
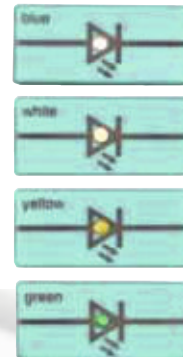
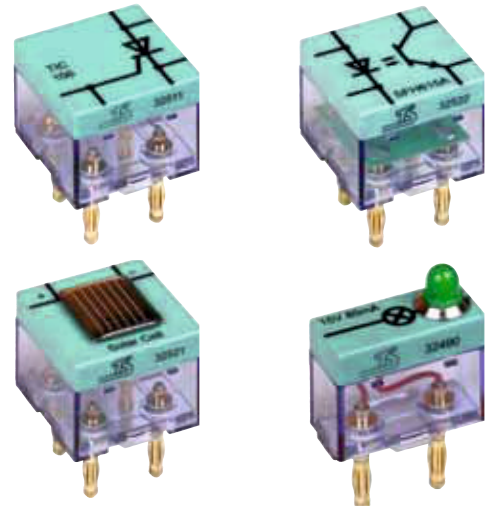

component overview

- › 32302 set of empty housings with 2 lambella plugs (10 pcs.)
- › 32305 set of empty housings with 2 lambella plugs (10 pcs.)
- › 32310 Film resistor 10 Ω /2 W
- › 32311 Film resistor 22 Ω /2 W
- › 32312 Film resistor 33 Ω /2 W
- › 32313 Film resistor 100 Ω /2 W
- › 32314 Film resistor 220 Ω /2 W
- › 32315 Film resistor 330 Ω /2 W
- › 32316 Film resistor 470 Ω /2 W
- › 32317 Film resistor 680 Ω /2 W
- › 32318 Film resistor 1 k Ω /2 W
- › 32319 Film resistor 2.2 k Ω /2 W
- › 32320 Film resistor 4.7 k Ω /2 W
- › 32321 Film resistor 10 k Ω /2 W
- › 32322 Film resistor 22 k Ω /2 W
- › 32323 Film resistor 47 k Ω /2 W
- › 32324 Film resistor 100 k Ω /2 W
- › 32325 Film resistor 1 M Ω /2 W
- › 32340 VDR resistor, 12 V/10 k Ω
- › 32342 NTC resistor (6 k Ω)
- › 32345 LDr resistor
- › 32370 c apacitor 100 pF/500 V
- › 32371 c apacitor 10 nF/500 V
- › 32372 c apacitor 47 nF/500 V
- › 32373 c apacitor 0.1 μ F/160V
- › 32374 c apacitor 0.22 μ F/160 V
- › 32375 c apacitor 0.47 μ F/160 V
- › 32376 c apacitor 1 μ F/100 V
- › 32390 Electrolytic capacitor 10 μ F/63 V
- › 32391 Electrolytic capacitor 100 μ F/35 V
- › 32392 Electrolytic capacitor 470 μ F/35 V
- › 32402 Linear potentiometer 1 k Ω 0.5 W
- › 32403 Linear potentiometer 10 k Ω 0.5 W
- › 32420 Transformer coil n = 300
- › 32421 Transformer coil n = 900
- › 32422 coil 100 mh
- › 32430 Taupe-wourn core (1 pair)
- › 32440 Zener diode 10 V/40 ma
- › 32441 Zener diode 3.33 V/130 ma
- › 32442 ga-as light emitting diode, red, without dropping resistor
- › 32443 Light source
- › 32444 LED, 5mm, blue
- › 32445 ge diode, aa118
- › 32446 LED, 5mm, warm white
- › 32447 LED, 5mm, yellow
- › 32448 LED, 5mm, green
- › 32450 si diode 1 a
- › 32480 Toggle switch
- › 32490 Lamp, green, 15 V
- › 32501 Transistor nPn, Bc237, base left
- › 32502 Transistor nPn, Bc140, base left
- › 32503 Transistor nPn, Bc140, base right
- › 32504 Transistor PnP, Bc160, base left
- › 32505 Unijunction transistor, Pn 2n4870
- › 32506 D-MOS field effect transistor, BS250, P-channel, gate left
- › 32507 JFET transistor, 2n5485,
25 V/10 ma, n-channel, gate left
- › 32508 JFET transistor, 2n5461,
20 V/10 ma, P-channel, gate left
- › 32510 Diac, Er 900
- › 32511 Thyristor, Tic 106
- › 32512 Triac, Tic 206
- › 32520 Photodiode
- › 32521 solar cell
- › 32522 optical coupler sFh615a
- › 32523 Phototransistor LPT80a
- › 32598 Operational amplifier OP741
with 4mm connection sockets on the top
- › 32485 relay Dc 12...15 V noc, 2 a
- › 32486 relay Dc 12...15 V ncc, 2 a
- › 32 601 ic socket, 14-pin, on plug-in plate for 19mm grid, plate
equipped with 2mm jacks for easy connection

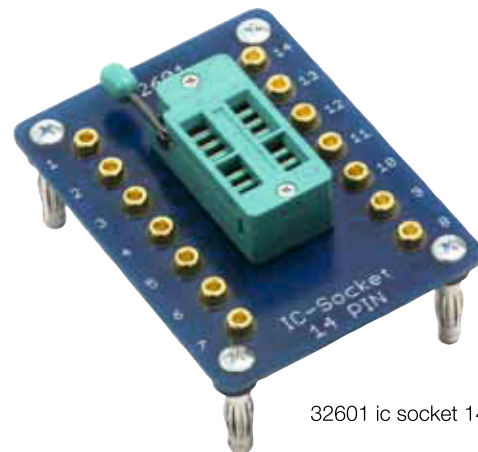

32601 ic socket 14 Pin

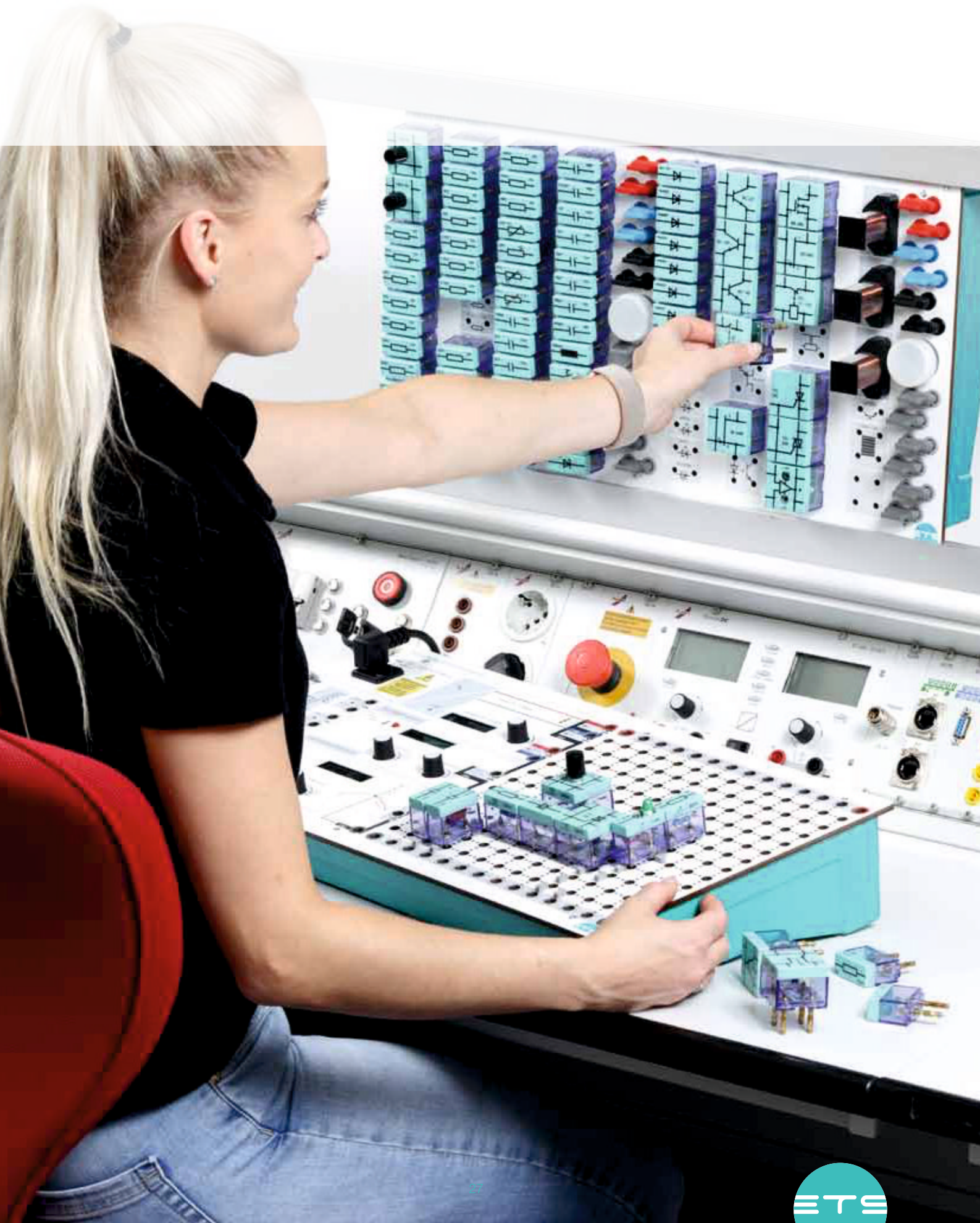

Mo Tors

Dc motor 24V/17W



Technical data

Dc motor 24V 17W, plug-in module for 19mm grid

- > Dc motor permanently excited
- > nominal voltage 24 V Dc
- > no-load current < 0,15 a
- > no-load current 7000 U/min
- > nominal current 1.0 a
- > nominal speed 6100 rpm
- > inputs-/outputs on 4mm plug for 19mm plug-in grid

1

No	Designation	Order No.
1	Dc motor 24V/17W	32620

Three-phase synchronous motor ac3/10V

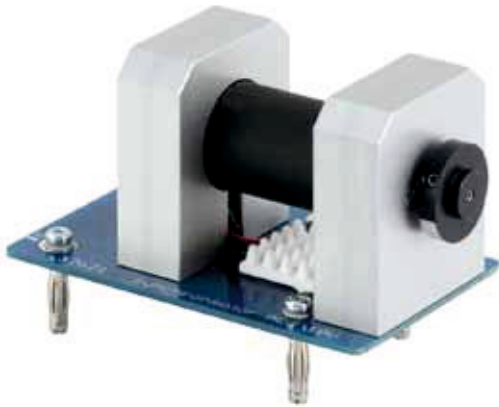

Technical data

- › synchronous motor ac3 10V,
plug-in module for 19mm grid
- › star 10V ac, 1-70 hz
- › rated speed 750 U/min at 50 hz
- › shaft end with washer
- › inputs/outputs on 4mm plug
for 19mm plug-in grid

2

No.	Designation	Order No.
2	Three-phase synchronous motor ac3/10V	32621



Dc TEchnoL ogy

courseware



1



2

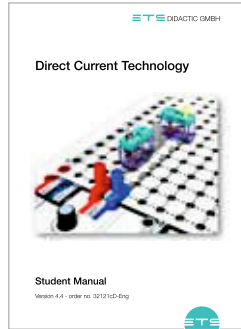

3

- DC Technology
 - electrical circuit
 - ohm's law
 - electrical resistors
 - voltage and current fault circuit
 - substitute voltage source
 - interconnection of voltage sources
 - electric power and work
 - efficiency of electrical power
 - power, voltage and current matching

Printed and digital

TECHNOCard®

Variable DC Voltage
The board's DC source settings are providing a variable DC voltage between 0 V and 30 V. The setting of this output voltage is done by means of the potentiometer. The conversion of the adjustable DC voltage to the level of the LC display in the laboratory is done with a digital display (LED).

Three-phase Source
The signal amplitude setting is done with the incremental adjuster. The signal amplitude can be set between 10 V_{rms} and 150 V_{rms}. The signal frequency is known in the LC display. The setting of the frequency from 1 Hz to 400 Hz is done with the incremental adjuster. The signal frequency can be set continuously without any steps. Other related to the frequency is represented in 1 Hz steps. When connected to the board, the frequency is determined by 1 Hz steps. The frequency 50 Hz can be achieved by connecting the adjuster.

CAUTION!
Please observe all safety instructions. Do not touch the board when it is powered on. Do not touch the board when it is powered on. Do not touch the board when it is powered on.

4

No.	Designation	Order No.
1	set of ET's ring binders	91903
2	Dc Technology - instructor's Manual	32120cD-Eng
3	Dc Technology - student Manual	32121cD-Eng
4	TECHNO Card - Electronic circuits Board ii	32201-Eng

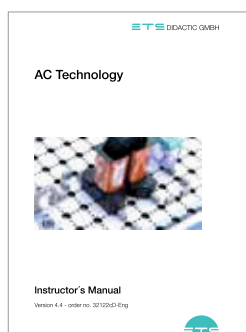

1

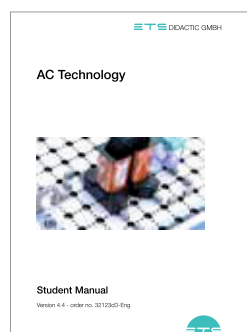

2

AC Technology

- › rectifier diodes
- › rectifier circuits
- › Z dioden
- › voltage stabilisation
- › overvoltage protection
- › voltage limiting
- › light emitting diodes
- › bipolar transistors
- › basic amplifier circuits
- › unipolar transistors
- › junction FET
- › insulated gate FET
- › unijunction transistor (UJT)
- › diac
- › thyristor triode
- › triac
- › gate control

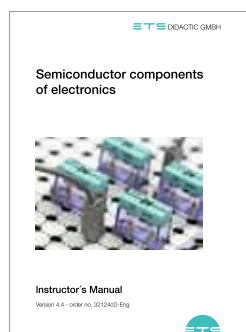

3

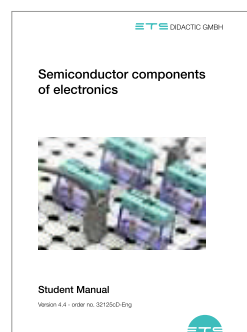

4

Semiconductor components of electronics

- › multistage amplifiers
- › darlington amplifier
- › emitter coupled amplifiers
- › phase inverting stages
- › differential amplifiers
- › DC voltage amplifiers
- › push-pull amplifier
- › feedback
- › inverting oPV
- › non-inverting oPVt
- › impedance converter
- › summing oPV
- › subtracting oPV
- › integrating oPV
- › differentiating OPV
- › sine wave generators
- › square wave generators

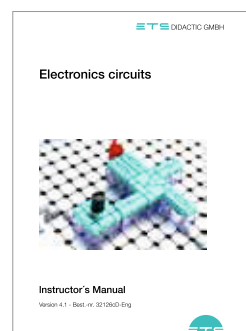

5

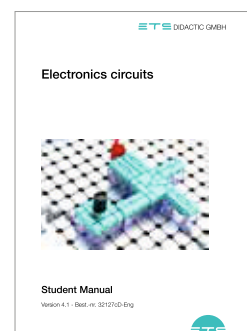

6

Electronics circuits

- › current types and their parameters
- › active power of alternating voltages
- › Three-phase alternating current
- › The capacitor in alternating current circuit
- › The coil in the alternating current circuit
- › interconnection of reactive and active resistors
- › oscillating circuits
- › RLC filter circuits (filters)
- › transformers

No.	Designation	Order No.
1	ac Technology - instructor's Manual	32122cD-Eng
2	ac Technology - s tudent Manual	32123cD-Eng
3	semiconductor components of electronics - instructor's Manual	32124cD-Eng
4	semiconductor components of electronics - s tudent Manual	32125cD-Eng
5	Electronics circuits - instructor's Manual	32126cD-Eng
6	Electronics circuits - s tudent Manual	32127cD-Eng

MEasUrEMEnT TEchnoL ogy

In electrical engineering, measuring instruments with differential input are required for optimum measured value acquisition of signal characteristics.

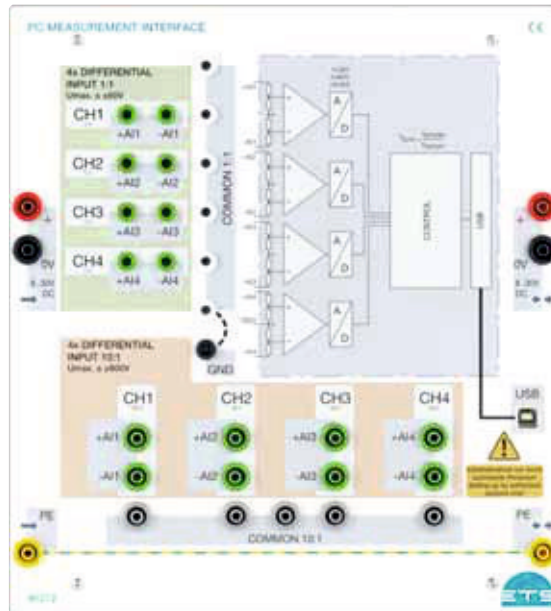

1

PC Measurement Interface

The "Pc measurement interface" is a four-channel measuring instrument with differential inputs. it enables the safe measurement of voltages and derived quantities up to 600V ac. The display and evaluation fo the measurement results is carried out by means of software via connected personal computer.

Performance parameters:

- › 4 analog input channels with differential input
- › 5 Mhz bandwidth (5.000.000 samples/s)
- › sampling rate up to 5Mhz per channel
- › input 1:1:
 - voltage resistant up to 200V_{eff} ac
 - 2mm safety sockets
 - measuring ranges from ±200mV to ±80V (peak value)
- › input 10:1:
 - voltage resistant up to 600V_{eff} ac
 - 4mm safety sockets
 - measuring range from ±2V bis ±800V (peak value)
- › all inputs touch-proof 600V, ca Tiii
- › all inputs clearly configurable by 19mm jumper plugs
- › 4 measuring instruments in one device
 - 4-channel oscilloscope
 - spectrum analyzer
 - transient recorder
 - voltmeter (average, true rms value)
- › UsB 2.0 high speed (480MBit/s)
- › optional operating voltage: 8 ... 30V Dc

- › included in delivery: UsB cable, software, operation instructions, operating system
- › requirements: Windows10 (32 or 64 Bit)

No.	Designation	Order No.
1	Pc Measurement interface	90272

The simultaneous measurement of the signal characteristics at the input of the B2 bridge circuit and at the output across the load resistor is only possible with an oscilloscope with differential input or isolation amplifier. The measuring interface has four differential inputs and makes such measuring tasks possible in a simple way.

in addition, the experiment descriptions contain ready-made measuring profiles for loading, from the measuring software to the measuring interface.

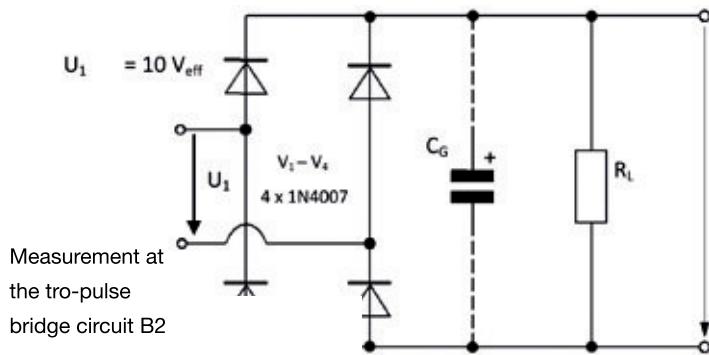
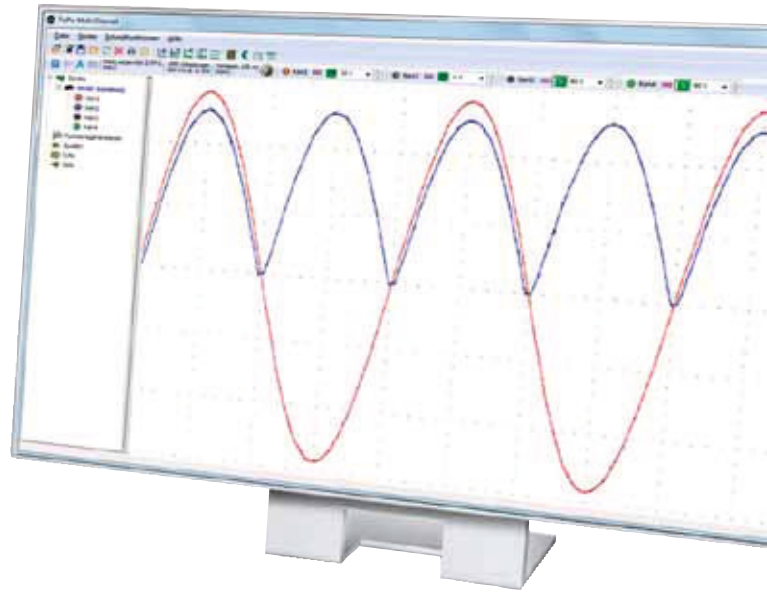

accEssoriEs

connecting systems and connections

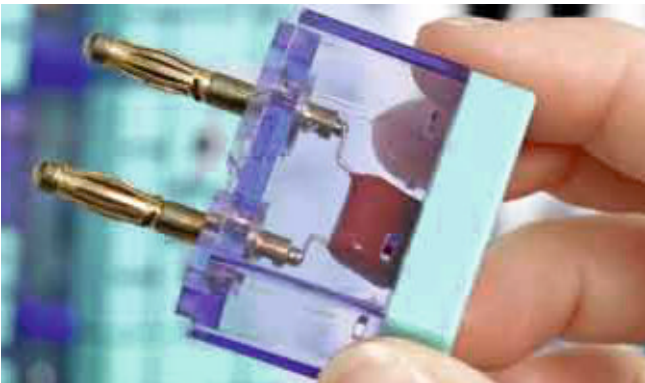

Making the connection...

Components and connections are provided with gold-plated lamella plugs assuring resistance against corrosion and low contact resistance.



2mm connections

› 70 connecting plugs 2mm (c6000306)

On the experimenting field provided with 4/2mm sockets, connections between components and to the power supply bar are made with 2mm connectors.



accessories connection technology 4mm

1) accessory set safety connection lines 11 pieces

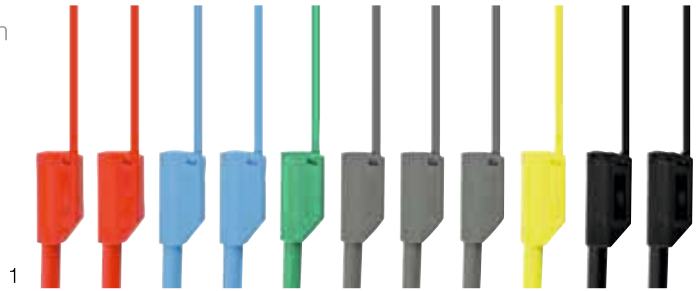

2) set of safety jumper plugs 24 pieces, colored



Measurement accessories

3) adapter Bnc plug to 4mm safety socket (c6010235)

Three adapters Bnc to 4mm safety connectors are needed to connect standard oscilloscopes.

3



No.	Designation	Order No.
1	safety connection lines (11-piece)	90030
2	safety bridge plug (24-pieces)	90036
3	Bnc plug to 4mm safety socket	c6010235



ELEc TricaL EnginEERING

Fundamentals Board Electrical Engineering

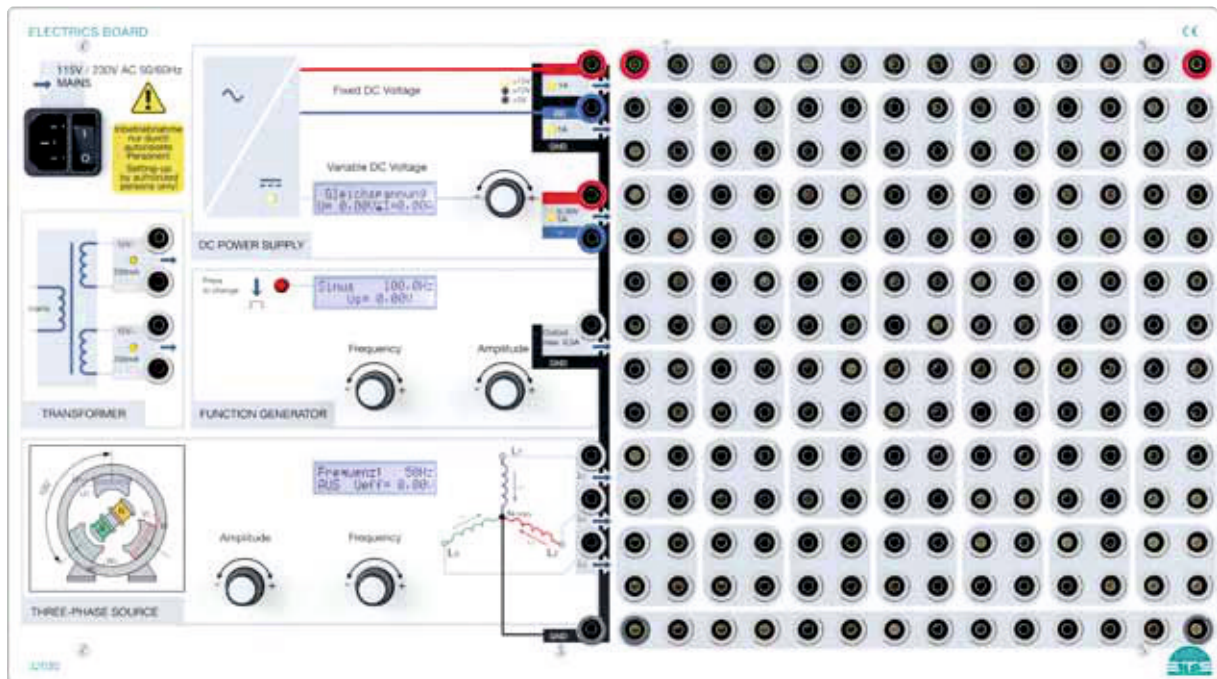

1

Learning objectives

- › Basic laws of electrical engineering
- › handling and measuring with oscilloscope, multimeter and function generator
- › Passive components in the direct current circuit
- › capacitor and coil in the alternating current circuit
- › Transformer
- › Three-phase systems
- › Behavior of semiconductors: diodes, transistors, thyristors
- › Operational amplifier

Technical data

- › Voltage sources Dc +/-15 V or +/-12 V or +/- 5 V/1 a; Dc 0...30 V / max. 1 a with voltage and current display; ac 2 x 12 V/0.2 a (fused via Polyswitch)
- › Function generator frequency 0.1 Hz...1 Mhz, amplitude 0...15 Vs and waveform adjustable, display of all quantities
- › Phase voltage 0...10 V (rms.); conductor voltage 0...17.3 V (rms.); frequency 1...400 Hz adjustable, display of all quantities, current load per phase max. 400 ma (rms.)
- › 42 plug-in fields in 19mm grid with 5 electrically connected 4mm safety sockets each
- › Main connection 230 V ac; 50 Hz; 75 W; protection class I
- › safety power supply outputs short-circuit- and regenerative-proof up to 40 V Dc/ 24 V ac, 40 W



No.	Designation	Order No.
1	Electrics Board	32030
n.ill.*	Electrics Board with component set 32203 installed in case	32030-Z03

* For more information, see page 52.

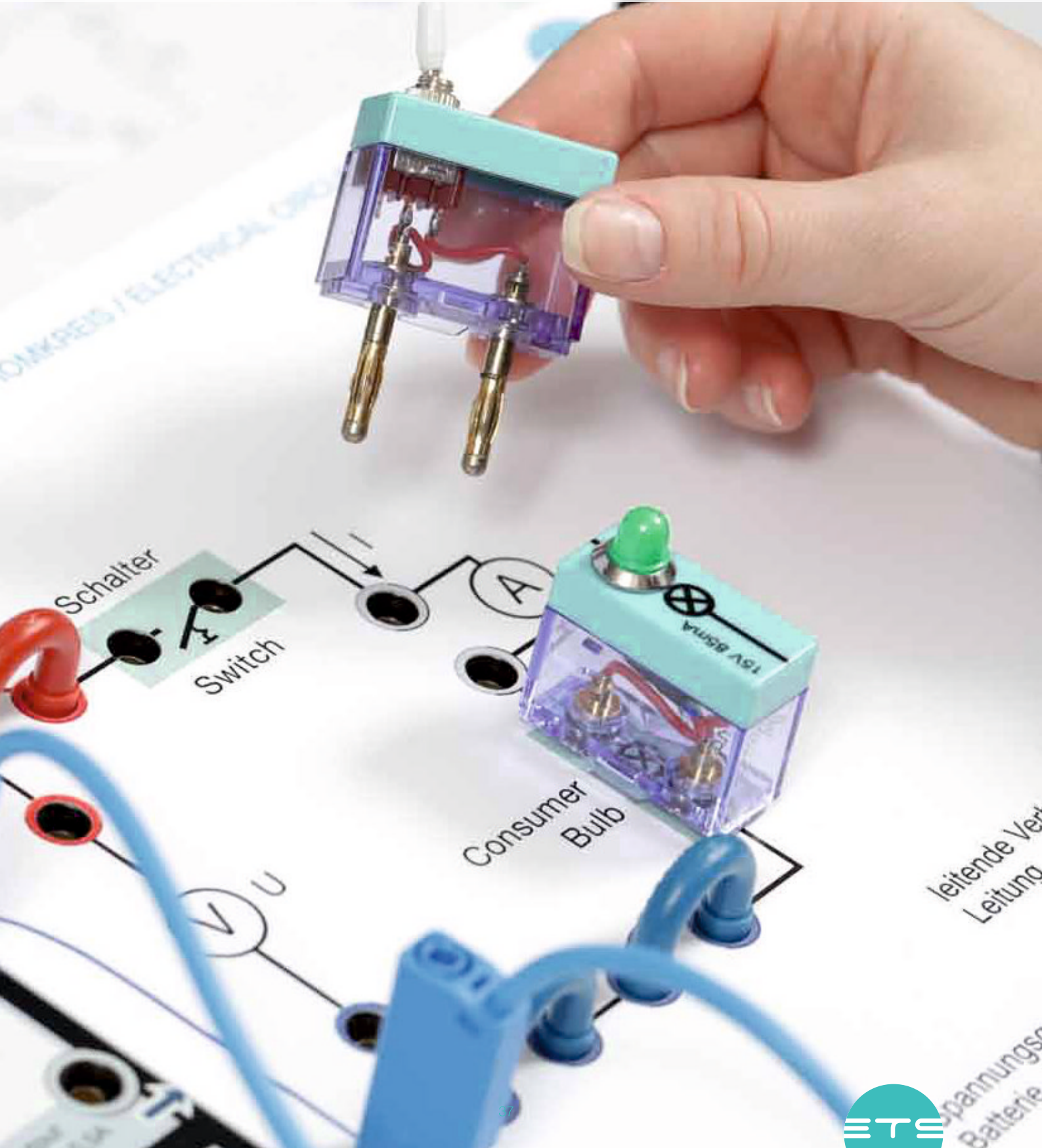

ELEc Trical EnginEERING

components

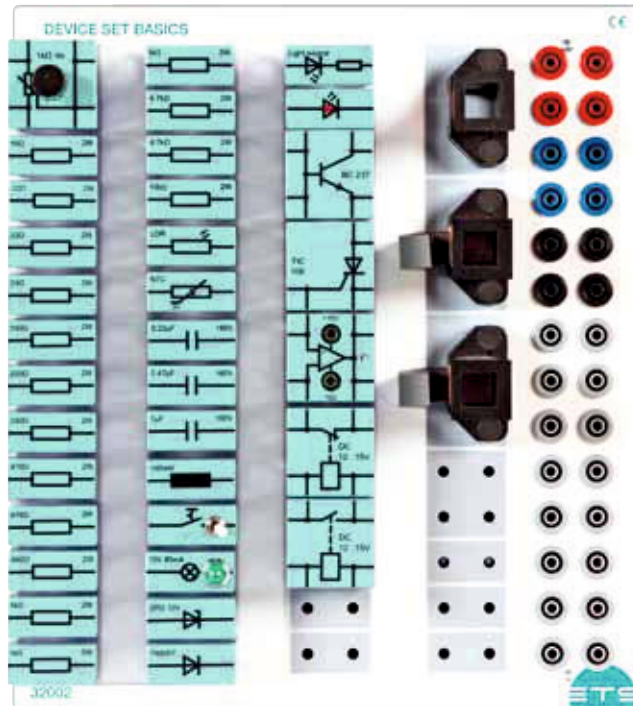

1

Technical data

storage plate printed incl. the following plug-in components:

- > 16 film resistors
10 Ω...10 kΩ
- > 1 LDr resistors
- > 1 nTc resistors
- > 3 capacitors
0.22 μF...1 μF
- > 1 potentiometer linear 1 kΩ
- > 1 transformer coil n = 300
- > 2 transformer coils n = 900
- > 1 cut band core (1 pair)
- > 1 coil 100 mh
- > 1 ga-as light emitting diode red
- > 1 si diode 1n4007
- > 1 zener diode ZPD 10 V
- > 1 transistor nPn Bc 237,
base left
- > 1 thyristor Tic 106
- > 1 toggle switch
- > 1 lamp 15 V
- > 1 loght source
- > 1 operational amplifier
- > 1 relay 12...15 V Dc,
switching contact
normally open
- > 1 relay 12...15 V Dc,
switching contact
normally closed



... with the possibility for the storage of jumper plugs.

No.	Designation	Order No.
1	Device set Basics	32002

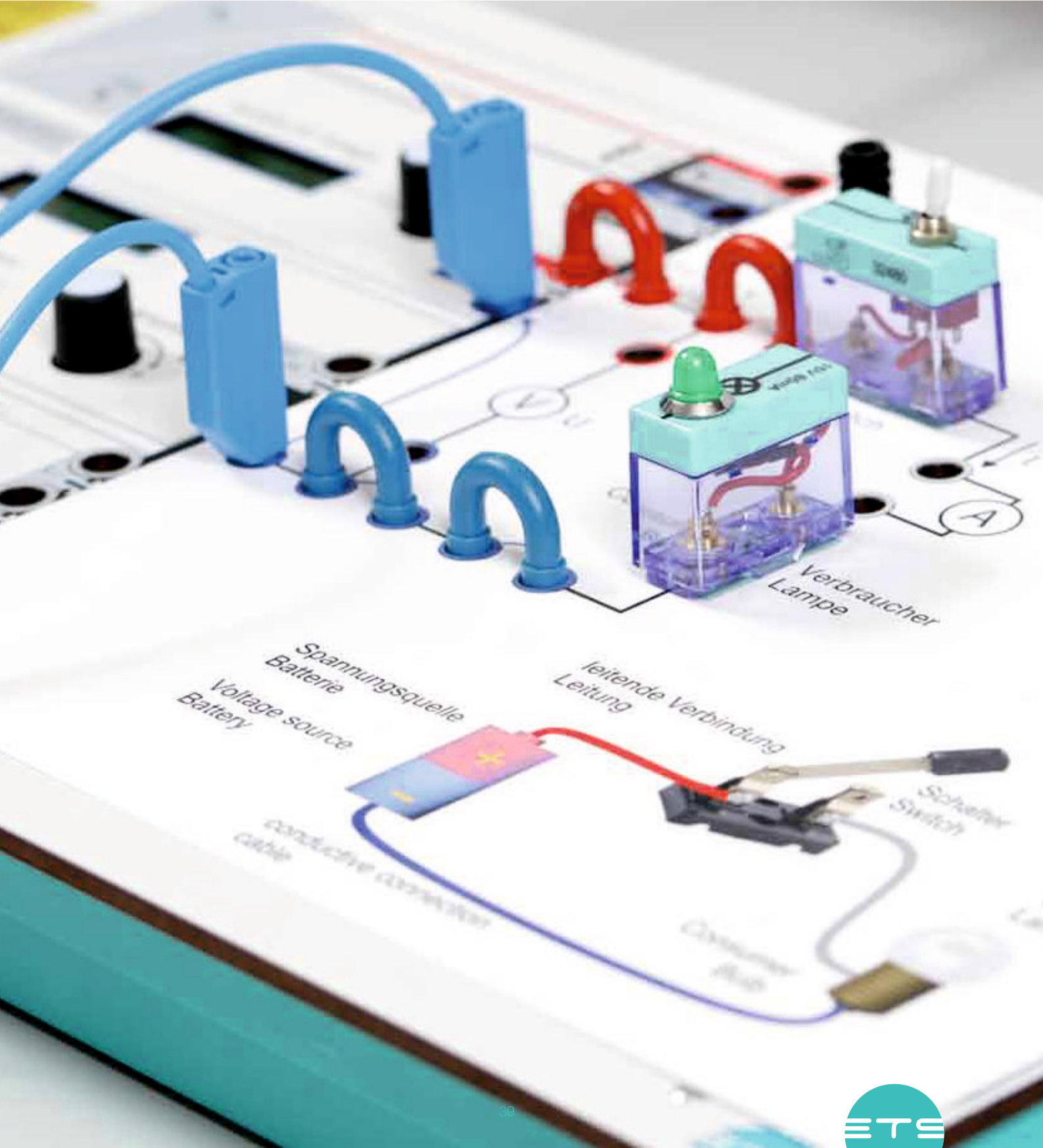

ELEc TricaL EnginEERING

Fundamentals Board Electrical Engineering

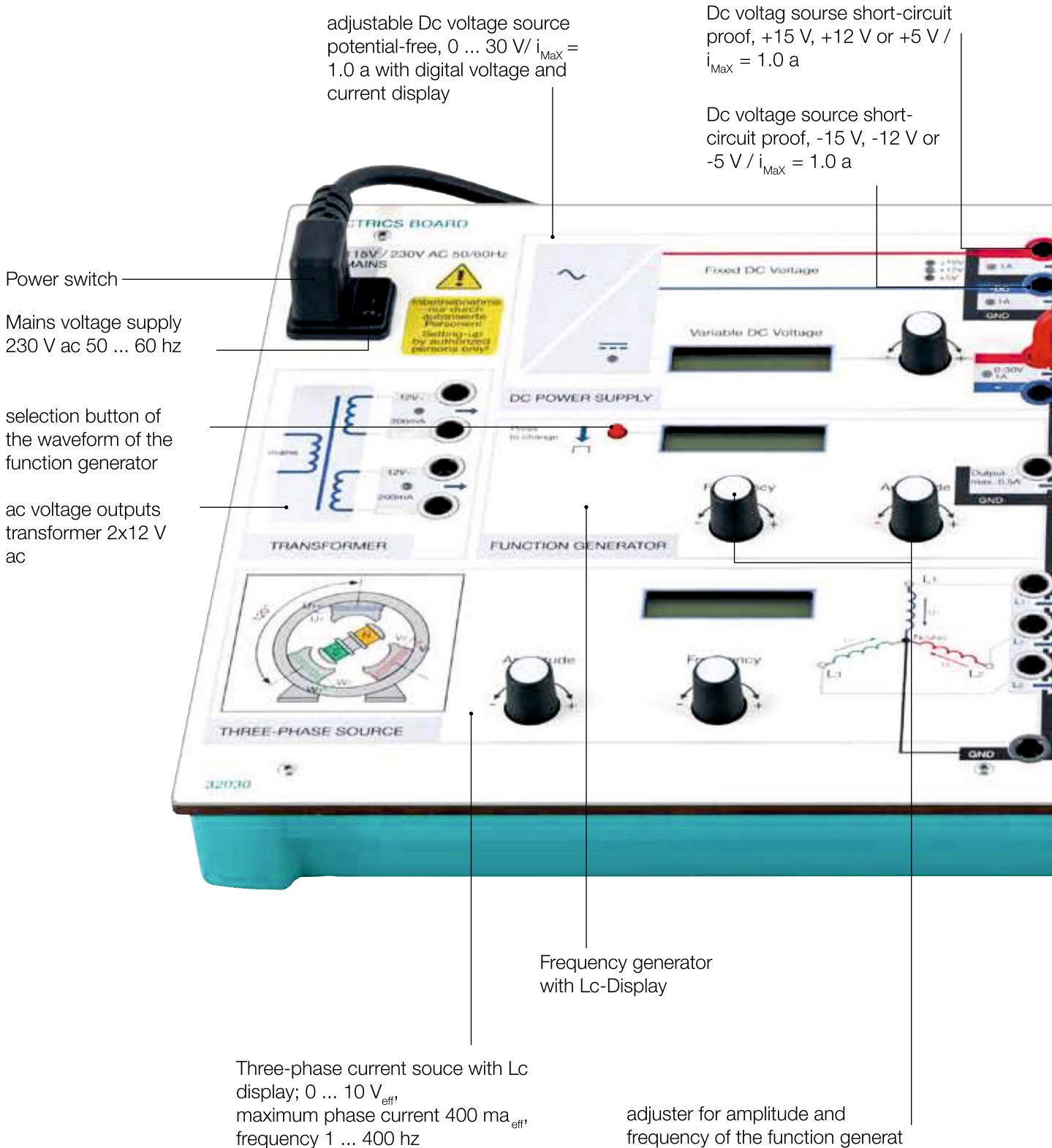

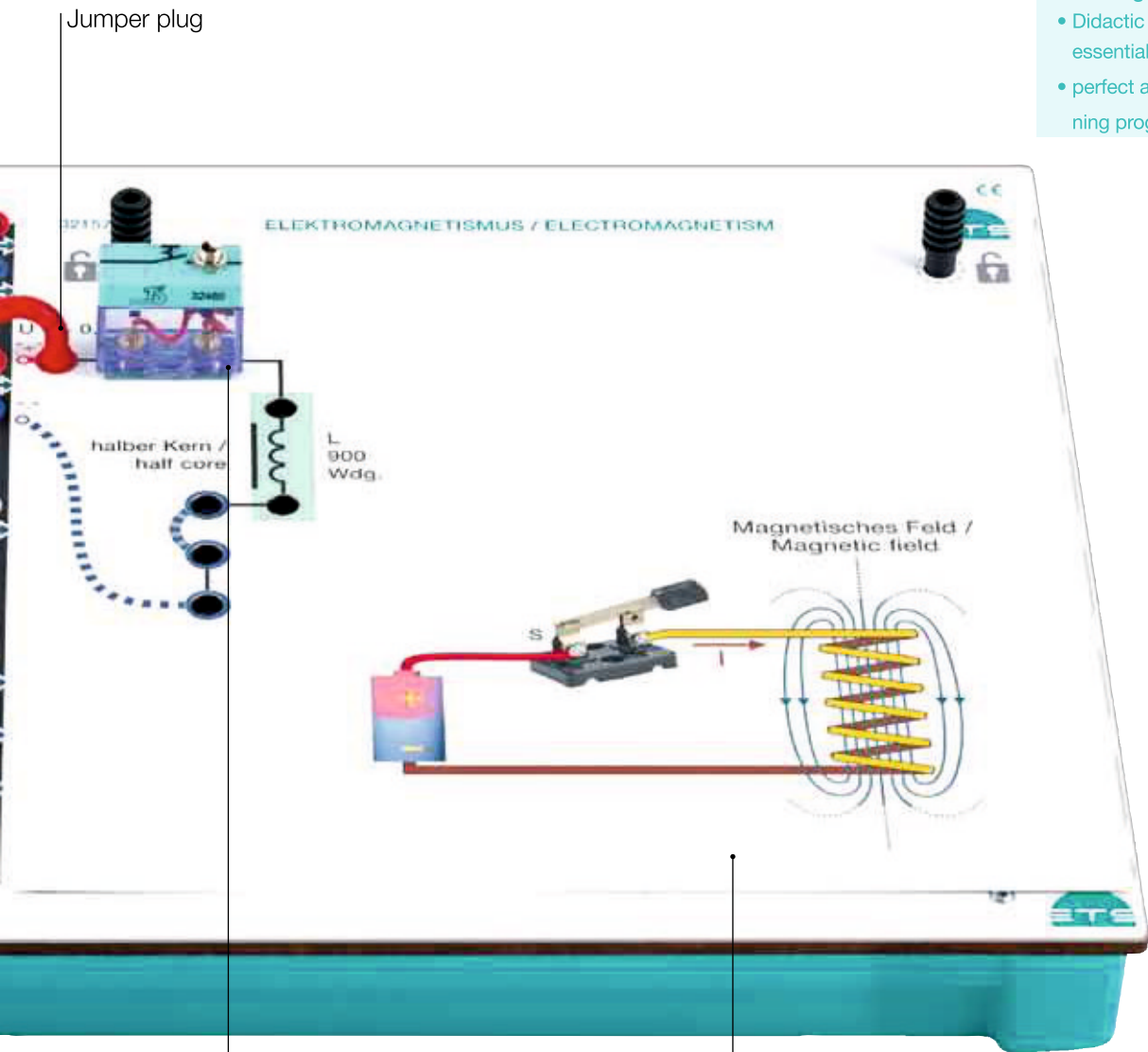

Electrics Board with equipped overlay mask in half format

Advantages:

- Didactic reduction on the essentials
- perfect adaption to the learning progress of the student

Jumper plug

Plug-in modules

overlay mask (half size) facilitates test setup and increases circuit reliability – ideal for beginners



DiDac Tic sUPPor T MasKs

reduction to the essentials

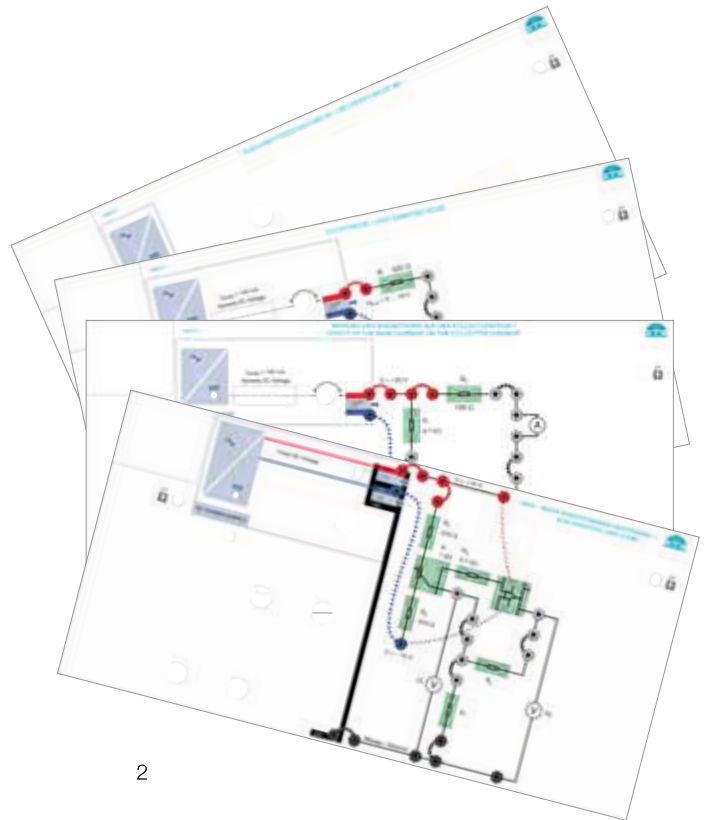
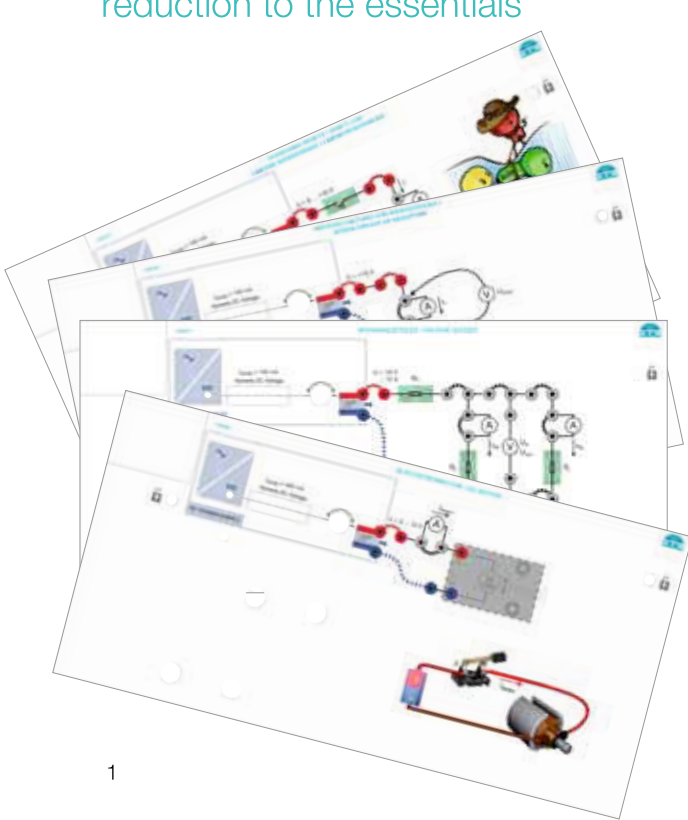

No.	Designation	Order No.
1	set 1 full format	32040
2	set 2 full format	32070





1

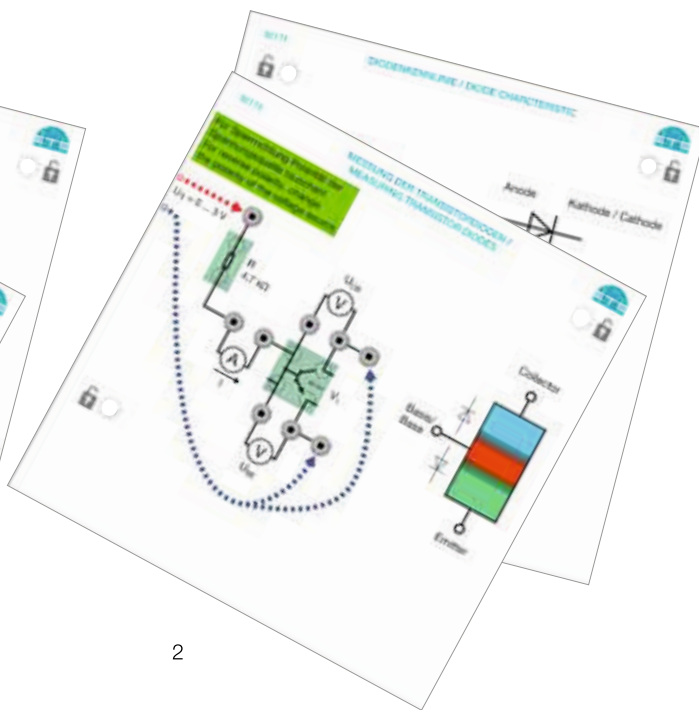

2

No.	Designation	Order No.
1	set 1 half format	32140
2	set 2 half format	32170

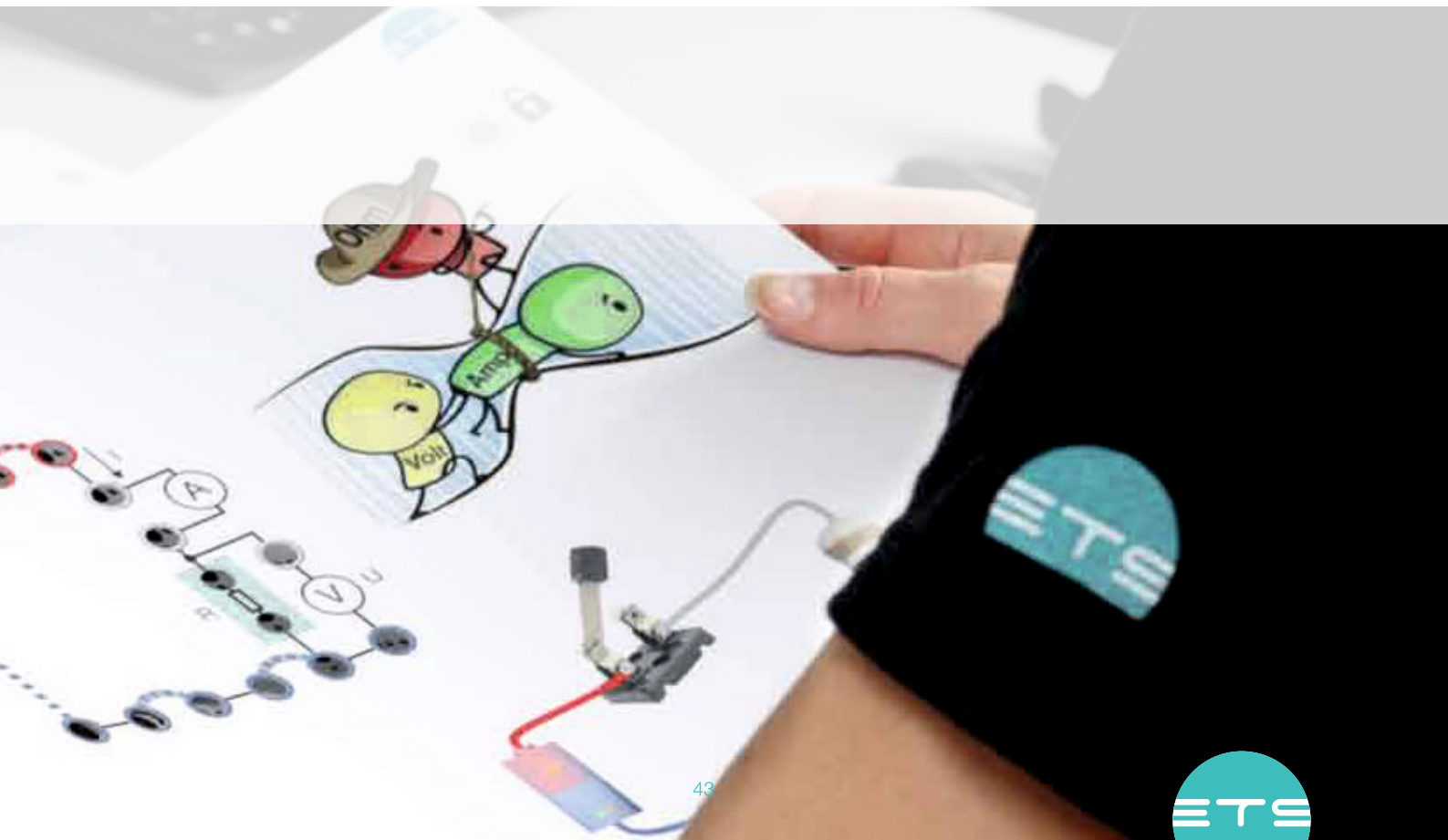

FUnD aMEnT aLs oF ELEc TricaL EnginEERING

courseware

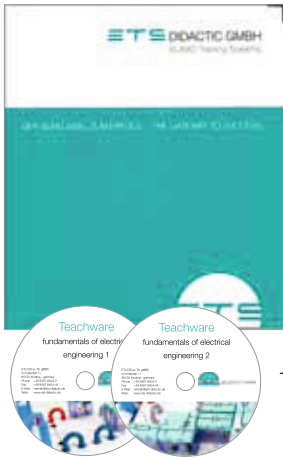

Printed and digital

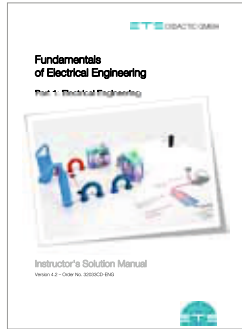

2

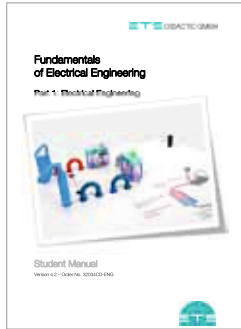

3

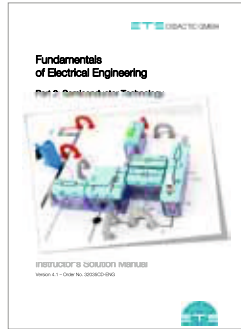

4

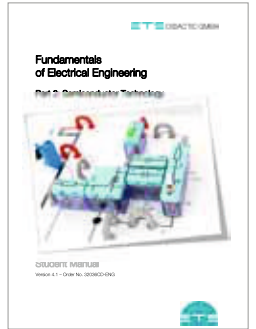

5

Manual content

- › The electrical circuit
- › ohm's law
- › Electrical resistors
- › interconnection of voltage sources
- › Electric power and work
- › Efficiency
- › Types of current and their characteristics
- › active power of alternating voltage
- › Three-phase ac (three-phase current)
- › The capacitor in the ac circuit
- › The coil in the ac current
- › interconnection of reactive and active resistors
- › oscillating circuits
- › RLC screening circuits (filter)
- › Transformers
- › Diodes and rectifier circuits
- › Bipolar transistors
- › The thyristor triode
- › Operational amplifiers
- › square wave generators

TECHNOCard®

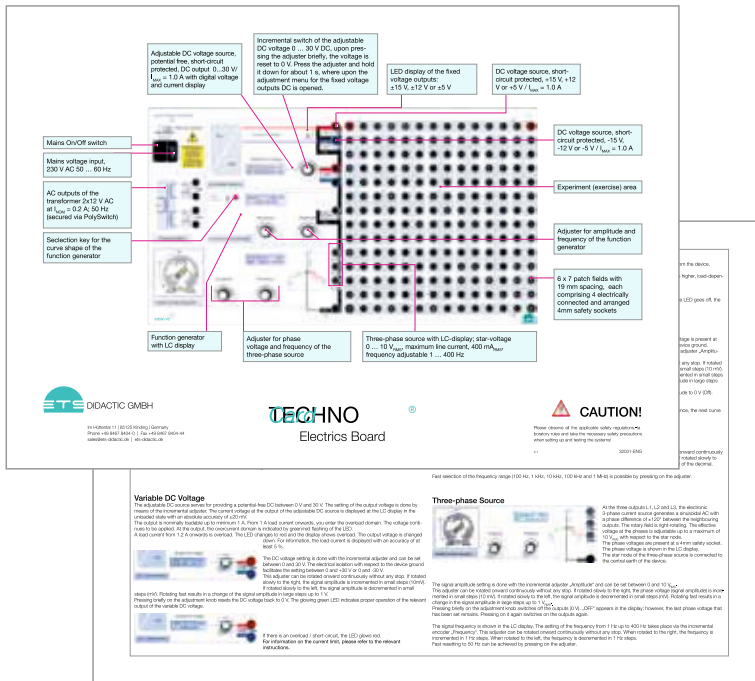

The TEchnoc ards® are a practical supplement to the training system. on them, the trainee finds a kind of knowledge store in concentrated, clear form for constant reference during practical work.

- › Display board in 303mm x 426mm format
- › Double-sided color design
- › robots, hard-wearing quality

6

No.	Designation	Order No.
1	set of ET ring binders	91903
2	Fundamentals of electrical engineering Part 1 - instructor's Manual	32033cD-Eng
3	Fundamentals of electrical engineering Part 1 - student Manual	32034cD-Eng
4	Fundamentals of electrical engineering Part 2 - instructor's Manual	32035cD-Eng
5	Fundamentals of electrical engineering Part 2 - student Manual	32036cD-Eng
6	TEchnoc ard - Electrics-Board	32031-Eng

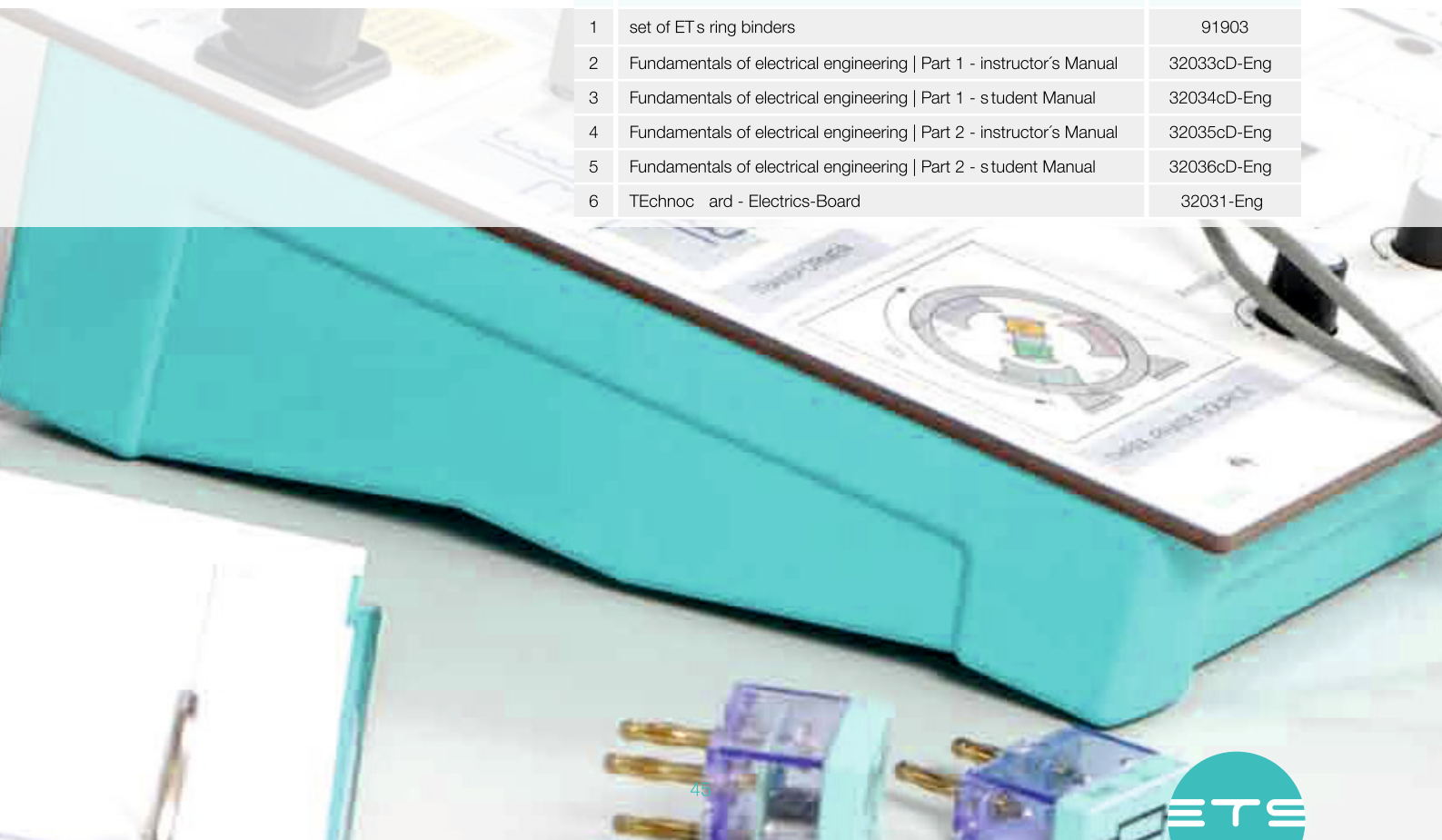

Basic circuits of a UTOMOTIVE ELECTRONICS

Electrical engineering in the motor vehicle

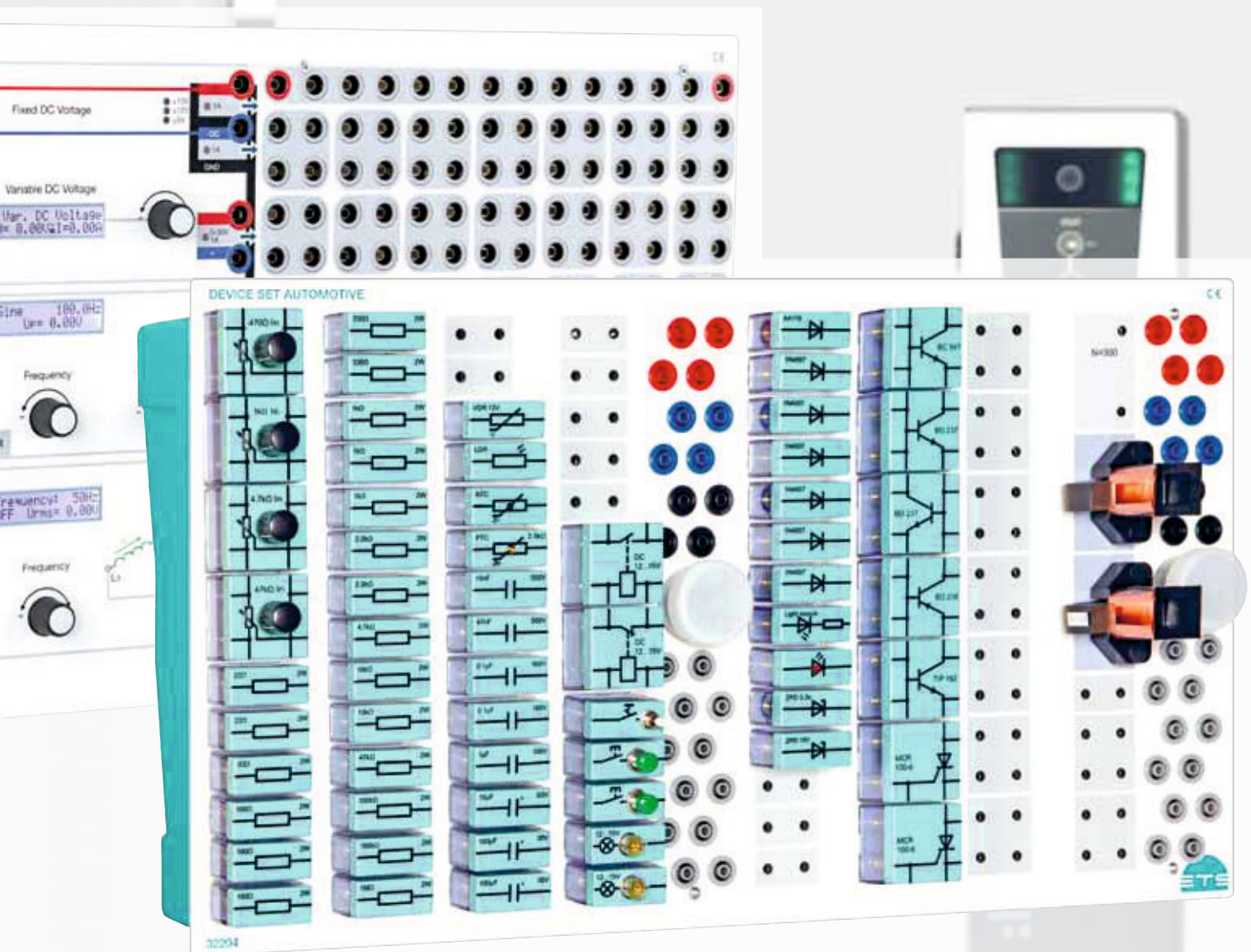

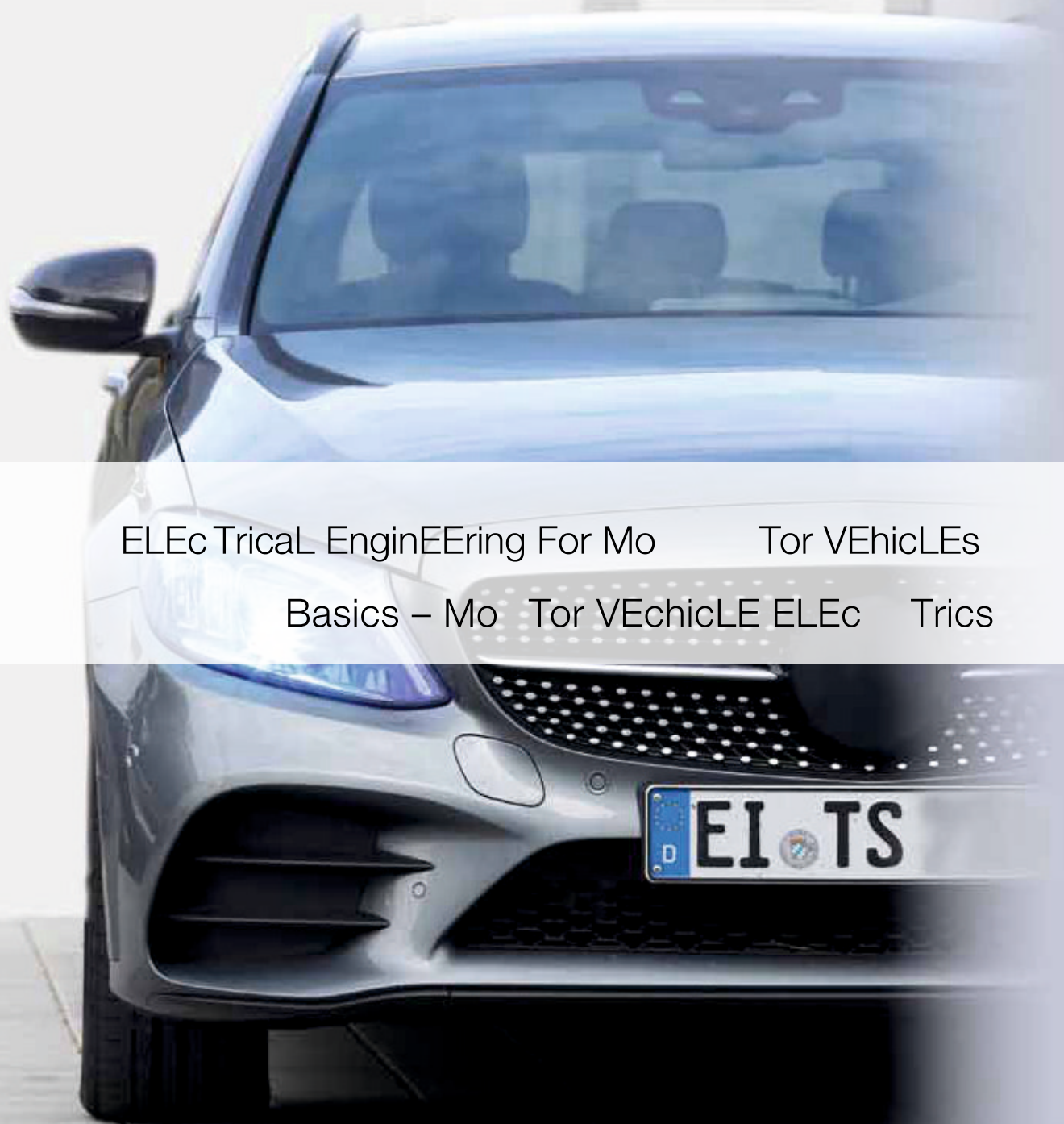

ELEc Trical EnginEEring For Mo Tor VEhicLEs

Basics – Mo Tor VEchicLE ELEc Trics

aUToMo TiVE

set of components

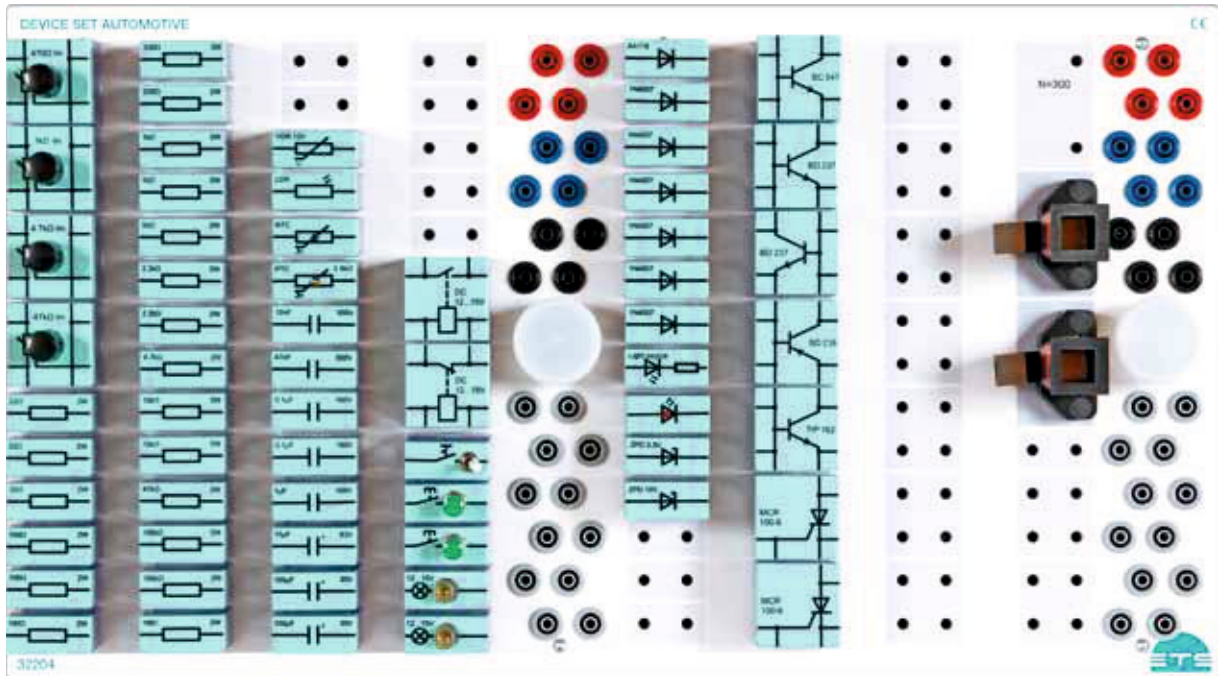

1

Technical data

The set of plug-in modules for experiments on the fundamentals of electrical engineering/electronics in automotive engineering, incl. storage plate for plug-in modules and 24 safety jumper plugs, printed with the circuit symbols of the components.

- } Film resistors 22 Ω/2 W
- } Film resistors 33 Ω/2 W
- } Film resistors 100 Ω/2 W
- } Film resistors 330 Ω/2 W
- } Film resistors 1 kΩ/2 W
- } Film resistors 2.2 kΩ/2 W
- } Film resistors 4.7 kΩ/2 W
- } Film resistors 10 kΩ/2 W
- } Film resistors 47 kΩ/2 W
- } Film resistors 100 kΩ/2 W
- } Film resistors 1 MΩ/2 W
- } Potentiometer, linear 470 Ω /0.5 W
- } Potentiometer, linear 1 kΩ /0.5 W
- } Potentiometer, linear 4.7 kΩ /0.5 W
- } Potentiometer, linear 47 kΩ/0.5 W
- } VDr resistor, 11 V/1 ma
- } LDr resistor
- } NTC resistor (6 kΩ)
- } PTC resistor (3.9 kΩ)
- } c apacitor 10nF / 500 V
- } c apacitor 47nF / 500 V
- } c apacitors 0,1µF / 160 V
- } Film resistors 22 Ω/2 W
- } Film resistors 33 Ω/2 W
- } Film resistors 100 Ω/2 W
- } Film resistors 330 Ω/2 W
- } Film resistors 1 kΩ/2 W
- } Film resistors 2.2 kΩ/2 W
- } Film resistors 4.7 kΩ/2 W
- } Film resistors 10 kΩ/2 W
- } Film resistors 47 kΩ/2 W
- } Potentiometer, linear 470 Ω /0.5 W
- } Potentiometer, linear 1 kΩ /0.5 W
- } Potentiometer, linear 4.7 kΩ /0.5 W
- } Potentiometer, linear 47 kΩ/0.5 W
- } VDr resistor, 11 V/1 ma
- } LDr resistor
- } NTC resistor (6 kΩ)
- } PTC resistor (3.9 kΩ)
- } c apacitor 10nF / 500 V
- } c apacitor 47nF / 500 V
- } c apacitors 0,1µF / 160 V

- } c apacitors 1µF/100 V 45V/500mW, base left
- } Electrolytic capacitors 10µF/63 V
- } Electrolytic capacitors 10 µF/35 V
- } coil n = 900
- } cut tape core (1 pair)
- } ga-as light emitting diode, red without series resistor
- } ge diode, 30 ma
- } Light source
- } si diodes, 1 a
- } Zener diode, 3.3 V/130 ma
- } Zener diode, 10V/40 ma
- } Thyristors Mcr100-6, 0,8 a
- } Transistor Bc547 nPn,
- } Transistor BD237 nPn, 80 V/25 W, base left
- } Transistor BD237 nPn, 80 V/25 W, base right
- } Transistor BD238 PnP, 80 V/25 W, base left
- } Darlington transistor TIP162 nPn 380 V/125 W, base left

No.	Designation	Order No.
1	Device set automotive	32204

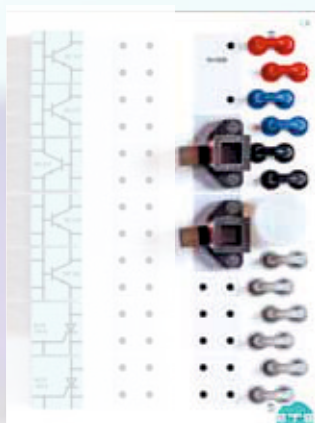

... with the possibility for the storage of jumper plugs.



Basics of a UToMo TiVE ELEc Trics/ELEc Tronics Fundamentals board electrical engineering

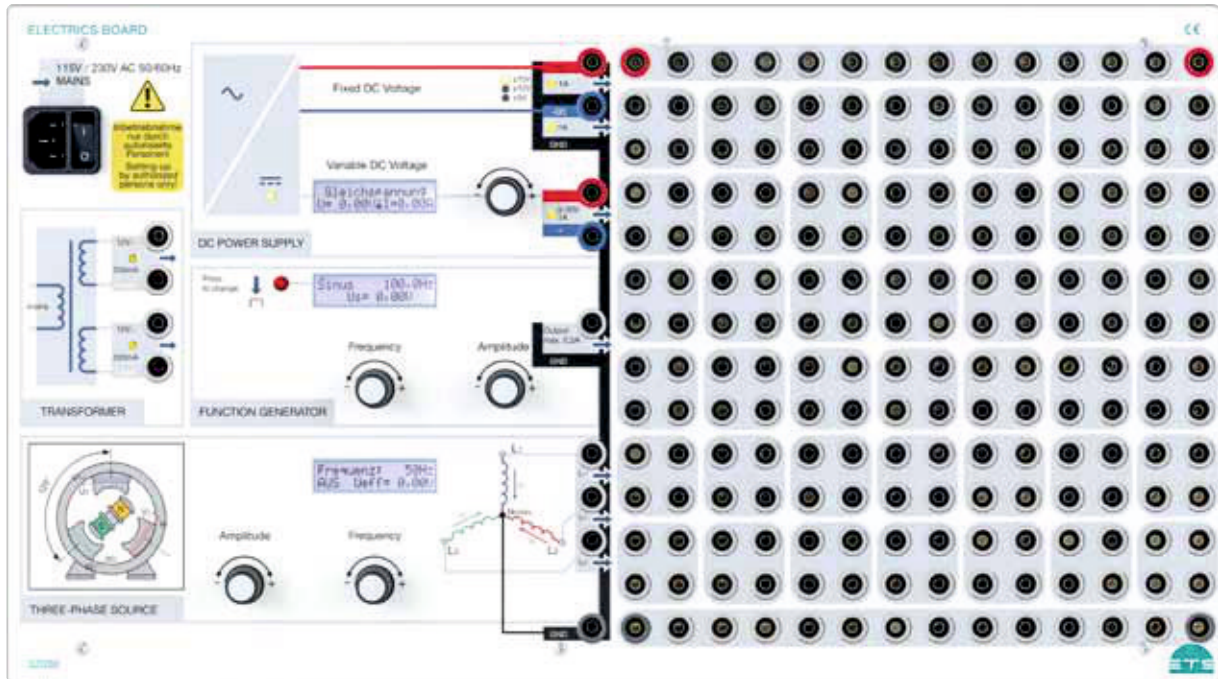

1

Learning objectives

- › Basic laws of electrical engineering
- › handling and measuring with oscilloscope, multimeter and function generator
- › Passive components in the direct current circuit
- › capacitor and coil in the alternating current circuit
- › Transformer
- › Three-phase systems
- › Behavior of semiconductors: diodes, transistors, thyristors
- › Operational amplifier

Technical data

- › Voltage sources Dc +/-15 V or +/-12 V or +/- 5 V/1 a; Dc 0...30 V / max. 1 a with voltage and current display; ac 2 x 12 V/0.2 a (fused via Polyswitch)
- › Function generator frequency 0.1 Hz...1 MHz, amplitude 0...15 Vs and waveform adjustable, display of all quantities
- › Phase voltage 0...10 V (rms.); conductor voltage 0...17.3 V (rms.); frequency 1...400 Hz adjustable, display of all quantities, current load per phase max. 400 ma (rms.)
- › 42 plug-in fields in 19mm grid with 5 electrically connected 4mm safety sockets each
- › Main connection 230 V ac; 50 Hz; 75 W; protection class I
- › safety power supply outputs short-circuit- and regenerative-proof up to 40 V Dc/ 24 V ac, 40 W



No.	Designation	Order No.
1	Electrics Board	32030



DEVICE SET AUTOMOTIVE

4700 Ω	3300 Ω				AA118	
1k Ω	3300 Ω				1N4007	
4.7k Ω	1k Ω	VDR 12V			1N4007	
47k Ω	1k Ω	LDR			1N4007	
220 Ω	1k Ω	NTC			1N4007	
220 Ω	2.2k Ω	PFC			1N4007	
330 Ω	2.2k Ω	10nF			1N4007	
1000 Ω	4.7k Ω	47nF			1N4007	
1000 Ω	10k Ω	1 μF			Light source	
1000 Ω	10k Ω	10 μF			2PD 3.3V	
1000 Ω	47k Ω	1 μF			2PD 10V	
1000 Ω	100k Ω	10 μF				
1000 Ω	100k Ω	100 μF				
1000 Ω	1M Ω	100 μF				

32204

FUnDaMEnT aLs oF a UTOMo TiVE ELEc Trics – c asE Mobile – ready for use anytime, anywhere

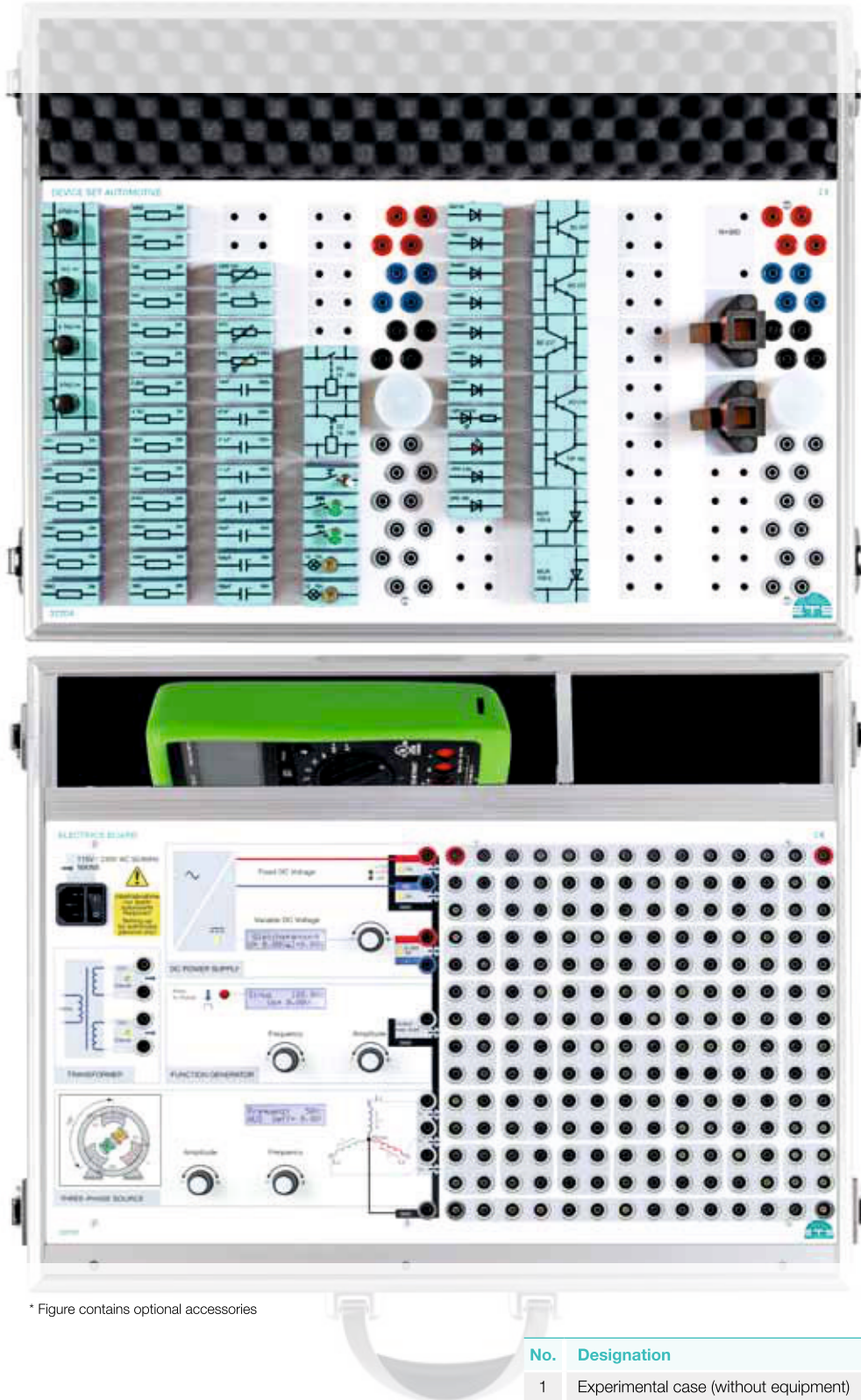

1 and 2

* Figure contains optional accessories

No.	Designation	Order No.
1	Experimental case (without equipment)	91801
2	Experimental case with Electrics Board and set of components Device set automotive	32030-Z04

coUrsEW arE

Fundamentals of electrical engineering for automotive engineering



1

Printed and digital

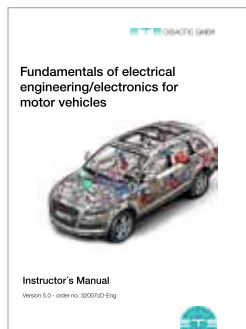

2

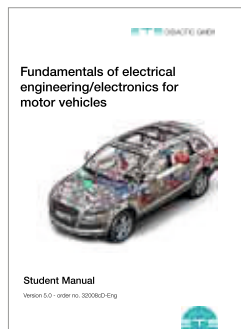

3

Manual content

- › The electric circuit
- › ohm's law
- › Electrical resistors
- › interconnection of voltage sources
- › Electric power and work
- › Efficiency
- › Types of current and their characteristics
- › active power of alternating voltages
- › Three-phase alternating current (three-phase-current)
- › The capacitor
- › Electromagnetism and coils
- › Transformers
- › Electric motor
- › Diodes and rectifier circuits
- › Bipolar transistors
- › Electrical and electronic switches
- › The thyristor triode

No.	Designation	Order No.
1	set of ET's ring binders	91903
2	Fundamentals of electrical engineering automotive - instructor's Manual	32007cD-Eng
3	Fundamentals of electrical engineering automotive - student Manual	32008cD-Eng
n.ill.	TEchnoc ard - Electrics Board (information on p.43)	32031-Eng



UniVERsaL soLUTions

Universal power supply

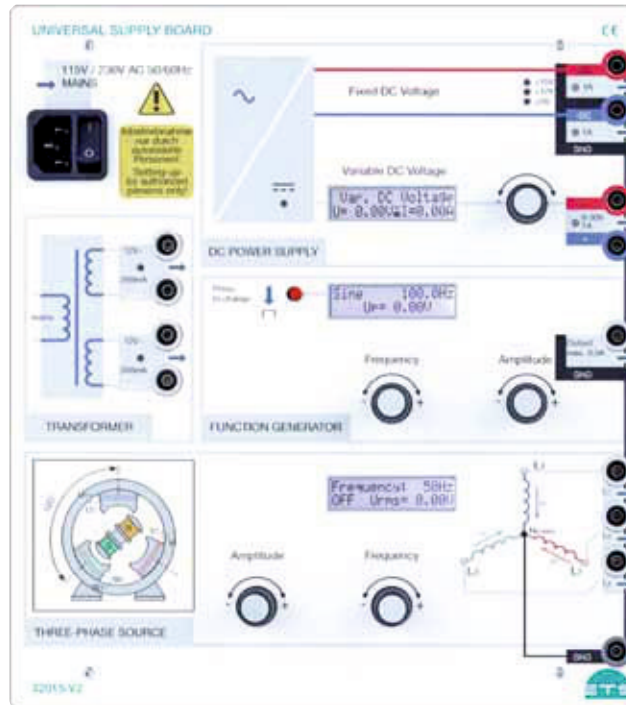

1

Technical data

- › Voltage sources Dc
+/- 15 V or +/- 12 V or
+/- 5 V/1 a; Dc 0...30 V/max.
1 a with voltage and current
display; ac 2 x 12 V/0.2 a
(fused via Polyswitch)
- › Function generator frequen-
cy 0.1 hz...1 Mhz, amplitude
0...15 Vs and waveform adjust-
able, display of all quantities
- › Three-phase generator
phase voltage 0...10 V (rms);
phase voltage 0...17.3 V (rms);
frequency 1...400 hz adjust-
able, display of all quantities,
current load per phase max.
400 ma (rms)
- › Mains connection 230 V ac;
50 hz; 75 W; protection class i

- › power supply outputs
short-circuit and regenerative
proof up to 40 V Dc/
24 V ac, 40 W



No.	Designation	Order No.
1	Universal supply Board	32015

Plug-in Boards / assembly Boards

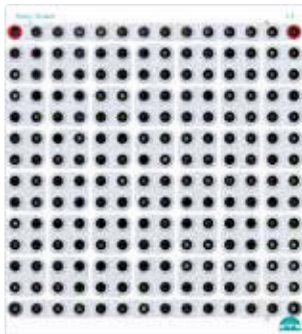

1

Technical data

Universal mounting plate for setting up experimental circuits with pluggable components

- › Patch panel with 4mm safety sockets, arranged in 19mm grid; four sockets each are electrically connected to each other. Electrical connections on the front panel are color-coded.
- › Experimentier board im Din a4 format with photorealistic, four-color design of the front panel
- › colored wire representation according to color code
- › The board surface is scratch-resistant due to a special coating
- › Didactic standard labeling with operating instructions and connection options facilitate commissioning for the user

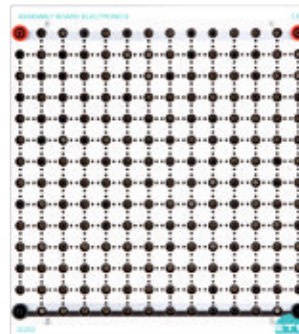

2

Technical data

Universal mounting plate for setting up experimental circuits with pluggable components

- › Patch panel with 4mm safety sockets, arranged in 19mm grid. Each 4mm socket is surrounded by four 2mm sockets, which are electrically connected to it.
- › Experimentier board im Din a4 format with photorealistic, four-color design of the front panel
- › colored wire representation according to color code
- › The board surface is scratch-resistant due to a special coating
- › Didactic standard labeling with operating instructions and connection options facilitate commissioning for the user

No.	Designation	Order No.
1	Basic Board	32013
2	assembly Board Electronics	32202

Training concEPT ELEc Trical EnginEERING

9 topics, 64 chapters, 775 pages in 3 folders

Teaching – Training – Technology



Discover the excellent concept of the Media-T3BoxX.

Supplement your teaching in a new, easy and uncomplicated way with a hardware-independent training concept for electrical engineering.

In nine chapters, participants are taught the basics of electrical engineering, based on a student script.

The lecturer document is characterized by a clear red thread.

1000 questions and answers, as well as many prepared exams, make sustainable teaching easy.

The documents are designed for approximately 160 – 175 teaching units.

Special design:

The instructor can see by the colors whether the student has the same information or whether he has to work out the formula, calculations or pictures with the participants.

Highlights

- › clear red thread
- › approx. 1000 questions and answers
- › 14 exams
- › Many PowerPoint slides
- › Each chapter is self-contained
- › hardware independent learning
- › Modular ordering possible

concept EXAMPLE

Topic: electrical machines

MEDIA-T³BoxX

teaching training technology

Lecturer

Presentation aids

Exam preparation

Exam

Dozent

Skizze einer zweipoligen Gleichstrommaschine ohne Kommutatorwicklung

8.2.2 Motor
Die Drehstrommaschine besteht aus Polblech, Nebenschluss, Bürsten und getriggerten Lüfter. Bei Drehstrommaschinen sind in der Regel die Poler als Ankerbauteil, weil ein Drehmoment entsteht.

8.2.3 Stromerzeuger
Die Drehmaschine wird mit Halbleiter oder Kommutatorwicklung, damit aus einem in Drehrichtung umgesetzten induzierten Strom ein Gleichstrom wird.

Skizzen von Stator

Der Stator besteht aus zwei, gegenüber liegenden, Halbkreisbögen. In einem Drahtwickelung, die über einen Kommutator, der die Umpolung der einzelnen Drahtwickelung bewirkt, angeschlossen ist.

Dozent

Wahlmöglichkeit für Drehstrommaschinen

Dieses System ermöglicht die Wahl zwischen zwei Drehstrommaschinen. Die Drehstrommaschine ist für die Nennspannung U_N ausgelegt. Die Drehstrommaschine ist für die Nennspannung $U_N/\sqrt{3}$ ausgelegt. Die Drehstrommaschine ist für die Nennspannung U_N ausgelegt.

8.2.3

In der Praxis sind über den Polblech der Drehstrommaschine ein gestrichelter Draht zu sehen.

Leistungsfluss und Drehmoment eines Drehstromgenerators

Dozent

8.2.3.3 Synchronmaschine als Phasenerzeuger

Die Drehstrommaschine ist ein Phasenerzeuger. Die Drehstrommaschine ist ein Phasenerzeuger. Die Drehstrommaschine ist ein Phasenerzeuger.

Skizze zur Darstellung einer Synchronmaschine und des Verhaltens bei Drehstromerzeugung

Generator liefert induktive Leistung in das Netz

Drehstromerzeugung

Motor nimmt induktive Leistung aus dem Netz auf

Generator liefert induktive Leistung in das Netz

Drehstromerzeugung

Motor nimmt induktive Leistung aus dem Netz auf

Dozent

8.2.3 Drehstromerzeugung

Die Drehstrommaschine ist ein Phasenerzeuger. Die Drehstrommaschine ist ein Phasenerzeuger. Die Drehstrommaschine ist ein Phasenerzeuger.

Skizzen von Stator

Die Drehstrommaschine ist ein Phasenerzeuger. Die Drehstrommaschine ist ein Phasenerzeuger. Die Drehstrommaschine ist ein Phasenerzeuger.

Präsentationsblätter

Möglichkeit zu einer Maschine mit einem Polblech

Die Drehstrommaschine ist ein Phasenerzeuger. Die Drehstrommaschine ist ein Phasenerzeuger. Die Drehstrommaschine ist ein Phasenerzeuger.

Präsentationsblätter

Wahlmöglichkeit einer Drehstrommaschine

Die Drehstrommaschine ist ein Phasenerzeuger. Die Drehstrommaschine ist ein Phasenerzeuger. Die Drehstrommaschine ist ein Phasenerzeuger.

Präsentationsblätter

Möglichkeit zu einer Maschine mit zwei Polblechen

Die Drehstrommaschine ist ein Phasenerzeuger. Die Drehstrommaschine ist ein Phasenerzeuger. Die Drehstrommaschine ist ein Phasenerzeuger.

Prüfungsunterlagen

8.1 Was ist eine Drehstrommaschine?

8.2 Was ist eine Drehstrommaschine?

8.3 Was ist eine Drehstrommaschine?

8.4 Was ist eine Drehstrommaschine?

8.5 Was ist eine Drehstrommaschine?

8.6 Was ist eine Drehstrommaschine?

8.7 Was ist eine Drehstrommaschine?

8.8 Was ist eine Drehstrommaschine?

8.9 Was ist eine Drehstrommaschine?

8.10 Was ist eine Drehstrommaschine?

8.11 Was ist eine Drehstrommaschine?

8.12 Was ist eine Drehstrommaschine?

8.13 Was ist eine Drehstrommaschine?

8.14 Was ist eine Drehstrommaschine?

8.15 Was ist eine Drehstrommaschine?

Questions

Questions and solutions

Prüfungsunterlagen und Lösungen

8.10 Wie wird die Drehstrommaschine als Drehstrommaschine verwendet?

Die Drehstrommaschine ist ein Phasenerzeuger. Die Drehstrommaschine ist ein Phasenerzeuger. Die Drehstrommaschine ist ein Phasenerzeuger.

8.11 Was ist eine Drehstrommaschine?

Die Drehstrommaschine ist ein Phasenerzeuger. Die Drehstrommaschine ist ein Phasenerzeuger. Die Drehstrommaschine ist ein Phasenerzeuger.

8.12 Was ist eine Drehstrommaschine?

Die Drehstrommaschine ist ein Phasenerzeuger. Die Drehstrommaschine ist ein Phasenerzeuger. Die Drehstrommaschine ist ein Phasenerzeuger.

Prüfungsunterlagen und Lösungen

8.13 Was ist eine Drehstrommaschine?

Die Drehstrommaschine ist ein Phasenerzeuger. Die Drehstrommaschine ist ein Phasenerzeuger. Die Drehstrommaschine ist ein Phasenerzeuger.

8.14 Was ist eine Drehstrommaschine?

Die Drehstrommaschine ist ein Phasenerzeuger. Die Drehstrommaschine ist ein Phasenerzeuger. Die Drehstrommaschine ist ein Phasenerzeuger.

8.15 Was ist eine Drehstrommaschine?

Die Drehstrommaschine ist ein Phasenerzeuger. Die Drehstrommaschine ist ein Phasenerzeuger. Die Drehstrommaschine ist ein Phasenerzeuger.

Prüfungsunterlagen und Lösungen

8.16 Was ist eine Drehstrommaschine?

Die Drehstrommaschine ist ein Phasenerzeuger. Die Drehstrommaschine ist ein Phasenerzeuger. Die Drehstrommaschine ist ein Phasenerzeuger.

8.17 Was ist eine Drehstrommaschine?

Die Drehstrommaschine ist ein Phasenerzeuger. Die Drehstrommaschine ist ein Phasenerzeuger. Die Drehstrommaschine ist ein Phasenerzeuger.

8.18 Was ist eine Drehstrommaschine?

Die Drehstrommaschine ist ein Phasenerzeuger. Die Drehstrommaschine ist ein Phasenerzeuger. Die Drehstrommaschine ist ein Phasenerzeuger.

Prüfungsunterlagen und Lösungen

8.19 Was ist eine Drehstrommaschine?

Die Drehstrommaschine ist ein Phasenerzeuger. Die Drehstrommaschine ist ein Phasenerzeuger. Die Drehstrommaschine ist ein Phasenerzeuger.

8.20 Was ist eine Drehstrommaschine?

Die Drehstrommaschine ist ein Phasenerzeuger. Die Drehstrommaschine ist ein Phasenerzeuger. Die Drehstrommaschine ist ein Phasenerzeuger.

8.21 Was ist eine Drehstrommaschine?

Die Drehstrommaschine ist ein Phasenerzeuger. Die Drehstrommaschine ist ein Phasenerzeuger. Die Drehstrommaschine ist ein Phasenerzeuger.

Exam 1

Exam 1 and solution

Exam 2

Exam 2 and solution



MEDia-T3-Bo XX

courseware



1

Printed and digital

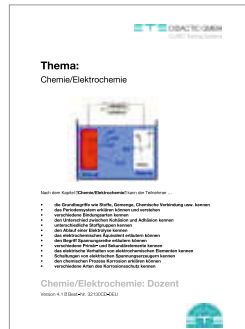

2

Chemistry/electrochemistry

- › Basic terms like substances, mixtures, chemical compound
- › Explain and understand the periodic table
- › Different types of bonds
- › Difference between cohesion and adhesion
- › Different groups of substances
- › sequence of an electrolysis
- › circuits of electric voltage generators
- › The electrochemical equivalent
- › Term voltage series
- › Different primary and secondary elements
- › The electrical behaviour of electrochemical elements
- › The chemical process corrosion
- › Types of corrosion protection

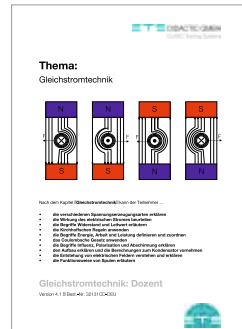

3

Direct current technology

- › Different types of voltage generation
- › Evaluate the effect of electric current
- › The terms resistance and conductance
- › Kirchhoff's rules
- › concept of energy, work and power
- › coulomb's law
- › Influence, polarization and shielding
- › construction of capacitor and the calculation
- › Formation of electric fields
- › The function of coils

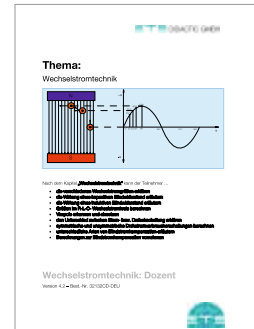

4

Alternating current technology

- › Explain alternating current quantities
- › Effect of capacitive reactance
- › Effect of inductive reactance
- › calculate quantities in the r-L-c alternating current circuit
- › recognize and use for poles
- › Difference between star and delta connection
- › calculate symmetrical and unbalanced three-phase circuits
- › Different types of reactive current compensation
- › calculations for reactive current compensation

No.	Designation	Order No.
1	set of ET s ring binders	91906
2	chemistry/electrochemistry	32130cD-Eng
3	Direct current technology	32131cD-Eng
4	alternating current technology	32132cD-Eng

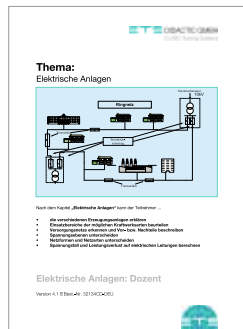

Printed and digital

1

2

3

4

Measuring technology

- › Difference of the basic terms measuring, testing and calibrating
- › Terms measurement accuracy and measurement error
- › Detect and avoid display and device errors
- › Measuring devices such as moving coil measuring mechanism, moving iron measuring mechanism, electrodynamic measuring mechanism
- › connecting transducers and their characteristics
- › signal converter
- › The oscilloscope

Electrical plants

- › Explain generation plants
- › Fields of application of the possible types of power plants
- › supply networks and their advantages and disadvantages
- › Differentiate between voltage levels
- › Distinguish between network forms and networks types
- › Voltage drop and power loss on electrical lines

Switchgear

- › actuator types
- › important characteristics
- › characteristics of line circuit breakers
- › Differences between disconnectors, load breakers and circuit breakers
- › Proper use of contactors and relays
- › selecting and using safety protection combinations

No.	Designation	Order No.
1	set of ET's ring binders	91906
2	Measuring technology	32133cD-Eng
3	Electrical plants	32134cD-Eng
4	switchgear	32135cD-Eng



MEDia-T3 Bo XX

courseware



1

Printed and digital



2

Transformers

- › Structure and effect of transformers
- › Processes during a load and no-load operation
- › short-circuit voltage and short-circuit current
- › Load characteristics
- › Design of single-phase and three-phase transformers
- › Basic requirements to ensure parallel operation of transformers
- › special transformers
- › Design of welding transformers



3

Electrical machines

- › Basic concepts of electrical machines
- › Difference between DC generator and motor
- › armature reaction, current turns etc.
- › circuit types of direct current machines
- › construction of three-phase machines
- › Different fields of application of three-phase machines
- › Distinguishing and using special motors
- › Recognize different single-phase motors

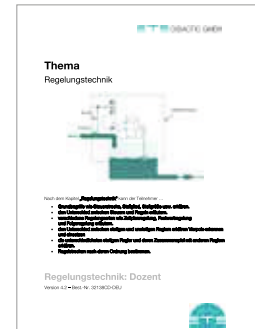

4

Control engineering

- › Basic terms such as control path, actuator, manipulated variable
- › Difference between open and closed loop control
- › Types of control such as schedule control, fixed value control and follow-up control
- › Difference between continuous and discontinuous controllers
- › The most different continuous controllers and their interaction with other controllers
- › controlled systems according to their order

No.	Designation	Order No.
1	set of ET's ring binders	91906
2	Transformers	32136cD-Eng
3	Electrical machines	32137cD-Eng
4	control engineering	32138cD-Eng

MEDIA-T³BoxX

teaching training technology



DIGITAL TRAINER BOARD II

110 - 240 V 50 / 60 Hz
MAINS



Inbetriebnahme nur durch autorisierte Personen!
Setting-up by authorized persons only!

Digital Input

H L H
H L H
H L H
H L H

Switch

Key

TTL Generator

F₀
0.01 - 10 kHz

Logic gate array with various gates: NOT, AND, OR, NAND, NOR, XOR, XNOR.

Resistor and capacitor components:
R3: 10 kΩ
R2: 2.2 kΩ
R1: 1 kΩ
C2: 1 μF
C1: 100 nF

74181 ALU chip with inputs X0-X3, Y0-Y3, Σ, and outputs Cn, Cn+1.

Terminal blocks J, K, C, B with various colored wires connected.

331

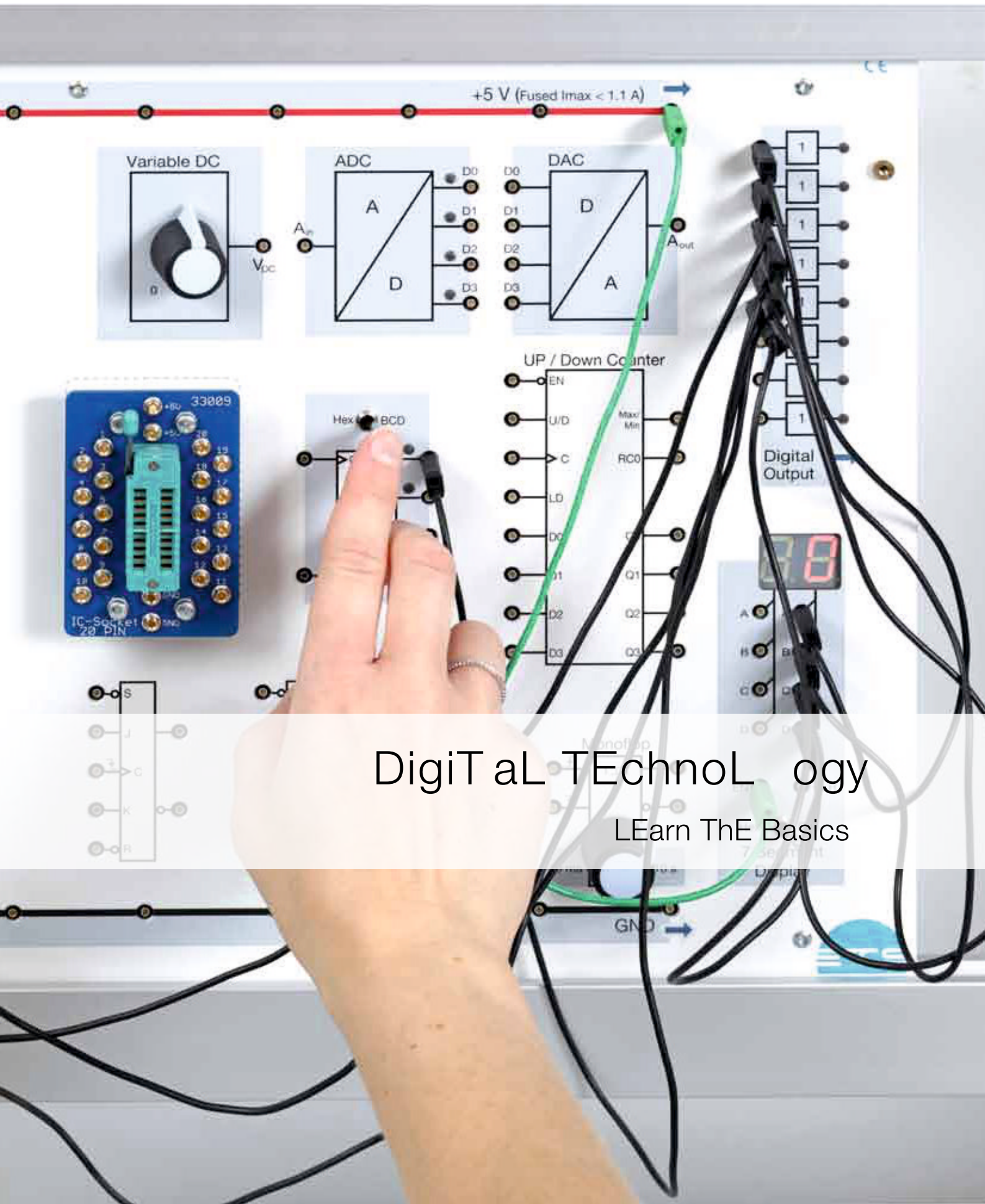

Digital Technology

Learn The Basics

harDW arE

Digital technology



Logic trainer

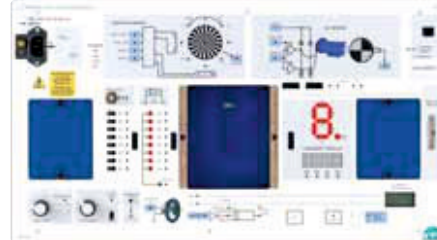

µ-trainer



component collection logic ics



Breadboard Wiring set



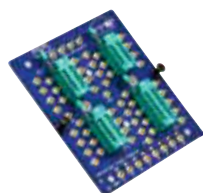

Universal logic module

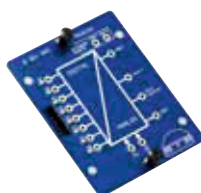

8Bit DaU module

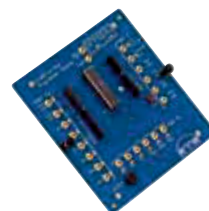

ELaBoino-one

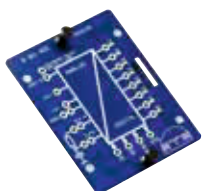

8Bit aDU module



Prototype module



DigiT aL TEchnoL ogy

Basic trainer digital technology

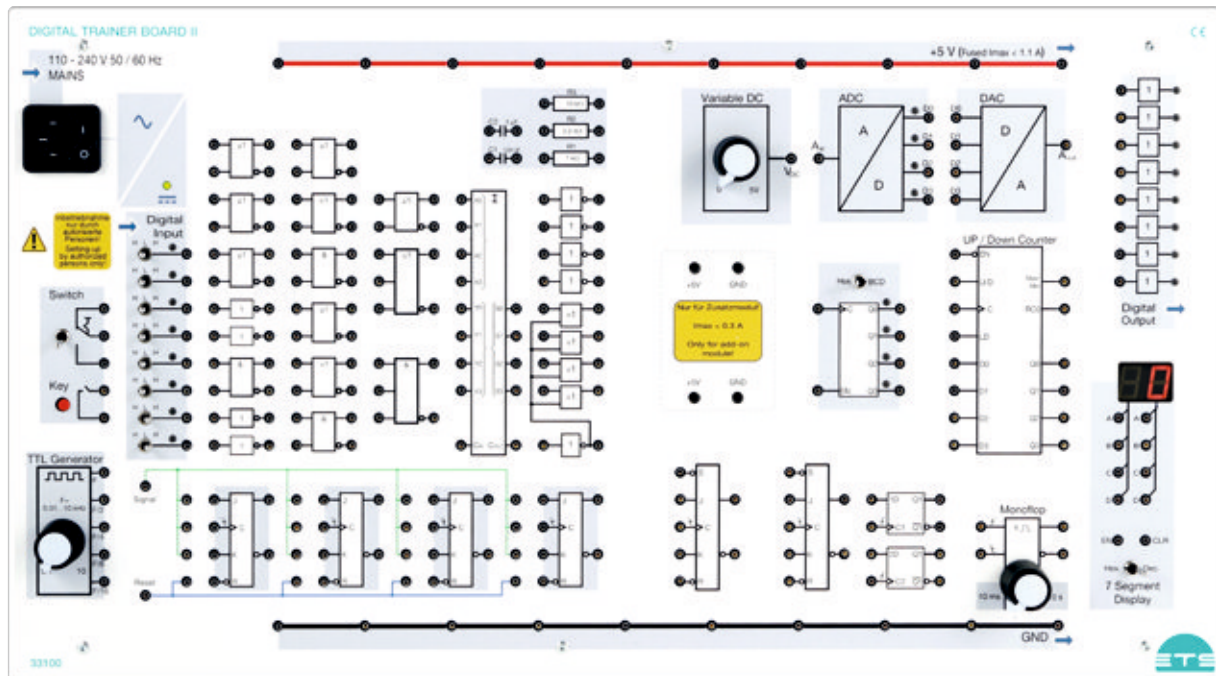

1

Learning objectives

- › Basic circuits, properties and characteristic of digital circuits
- › counters, flip-flops, registers, memories, aLU
- › Building and analyzing control systems with digital technology components

Integrated functions:

- › Power supply, +5 V Dc/1 a, stabilized and short-circuit proof
- › Variable adjustable clockgenerator, 0.1...10 khz, with downstream divider, divider factors: 2, 4, 8 and 16
- › Bounce-free L/h input switches
- › Toggle switch, freely switchable (not debounced)
- › Pushbutton, freely switchable (not debounced)
- › and/nanD gates with 2 inputs each
- › and/nanD gate with 3 inputs each
- › or/nor gates with 2 inputs each
- › or/nor gates with 3 inputs
- › Variable DC
- › 4-bit full adder
- › 4-bit DAC
- › UP/Down Counter
- › Monoflop
- › 7-segment display (2 digits) with integrated decoder, switchable from hexadecimal to decimal
- › Xor gates with 2 inputs
- › inverter
- › JK master-slave flip-flops
- › 4-bit full adder
- › switchable hEX/DEC counter with optical display
- › Up/down-4-bit binary
- › 2-bit buffer with release
- › variable adjustable monoflop, 10s, with positive or negative input
- › LED indicators with upstream driver
- › adjustable voltage source 0 ... 5 V
- › aDU 4 bit
- › DaU 4 bit
- › 3 resistors and 2 capacitors to build up of rc timers
- › Power-supplied slot for additional modules or ic sockets
- › Distribution rail, +5V and 0V

No.	Designation	Order No.
1	Digital Trainer Board ii	33100

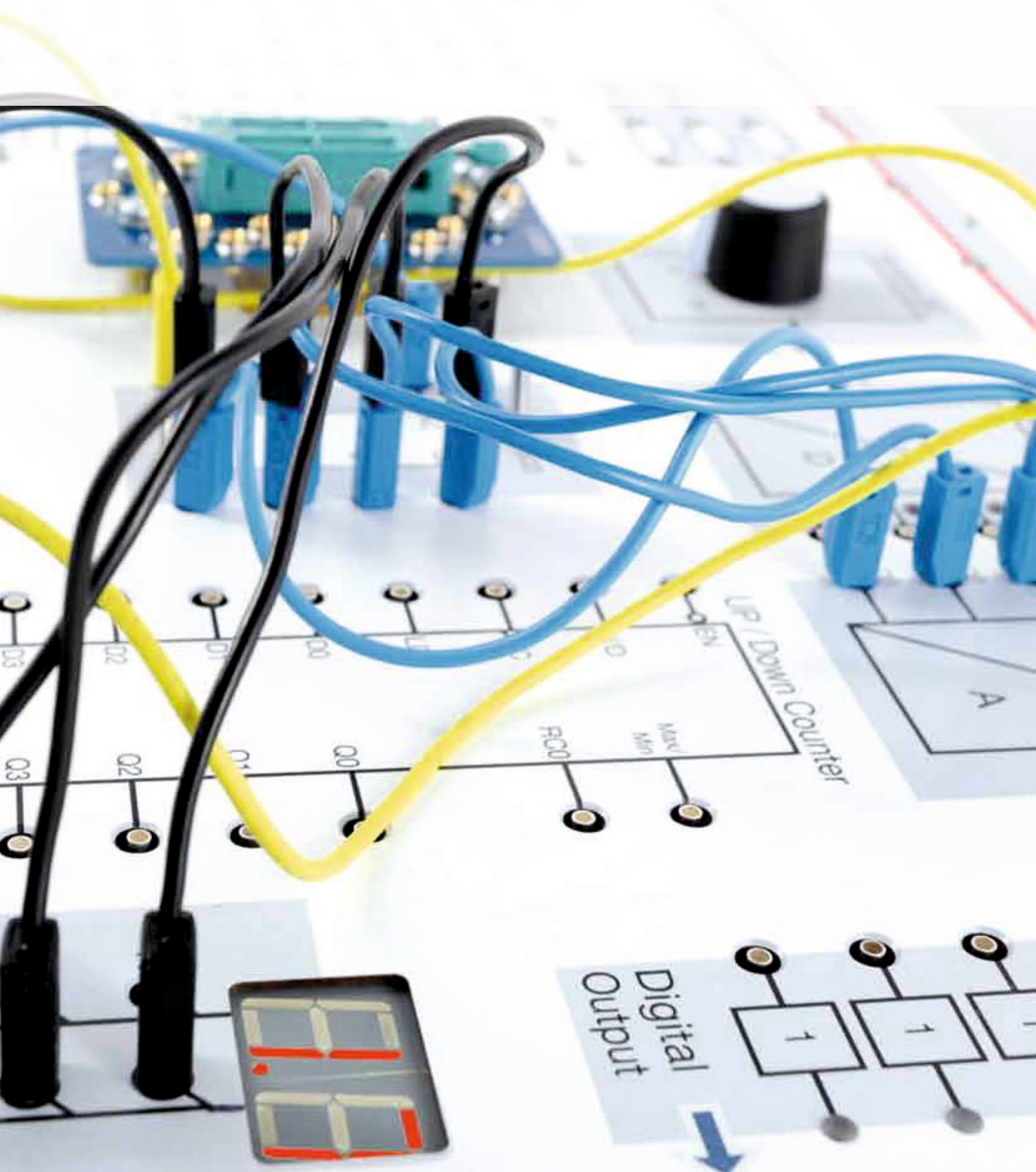

Digital Technology

Digital Trainer Board ii in the experiment "asynchronous 4-bit counter"

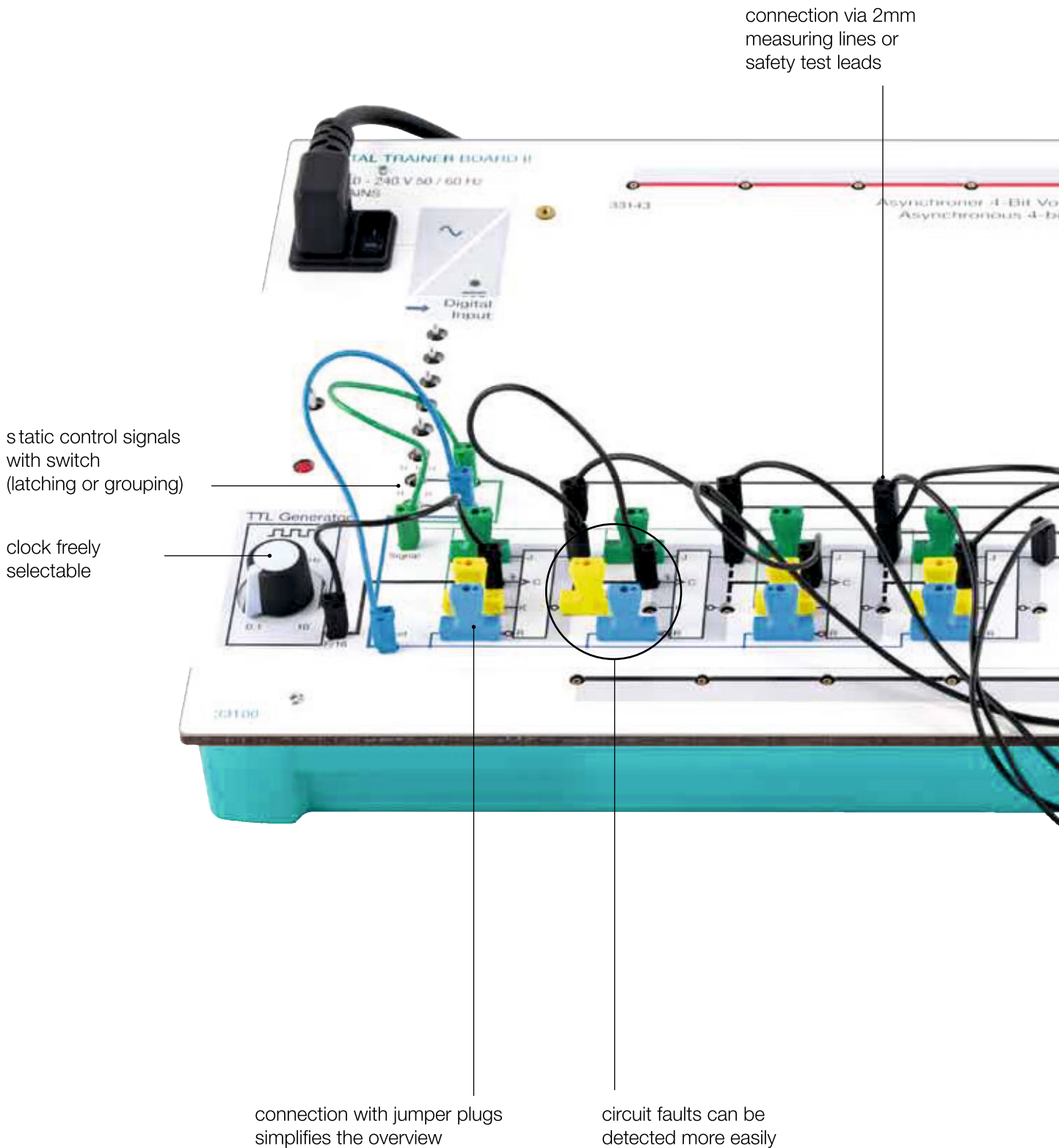

overlay mask for the experiment facilitate the experiment setup and provide an overview

Digital Trainer Board II including overlay mask for didactic reduction to the essentials.

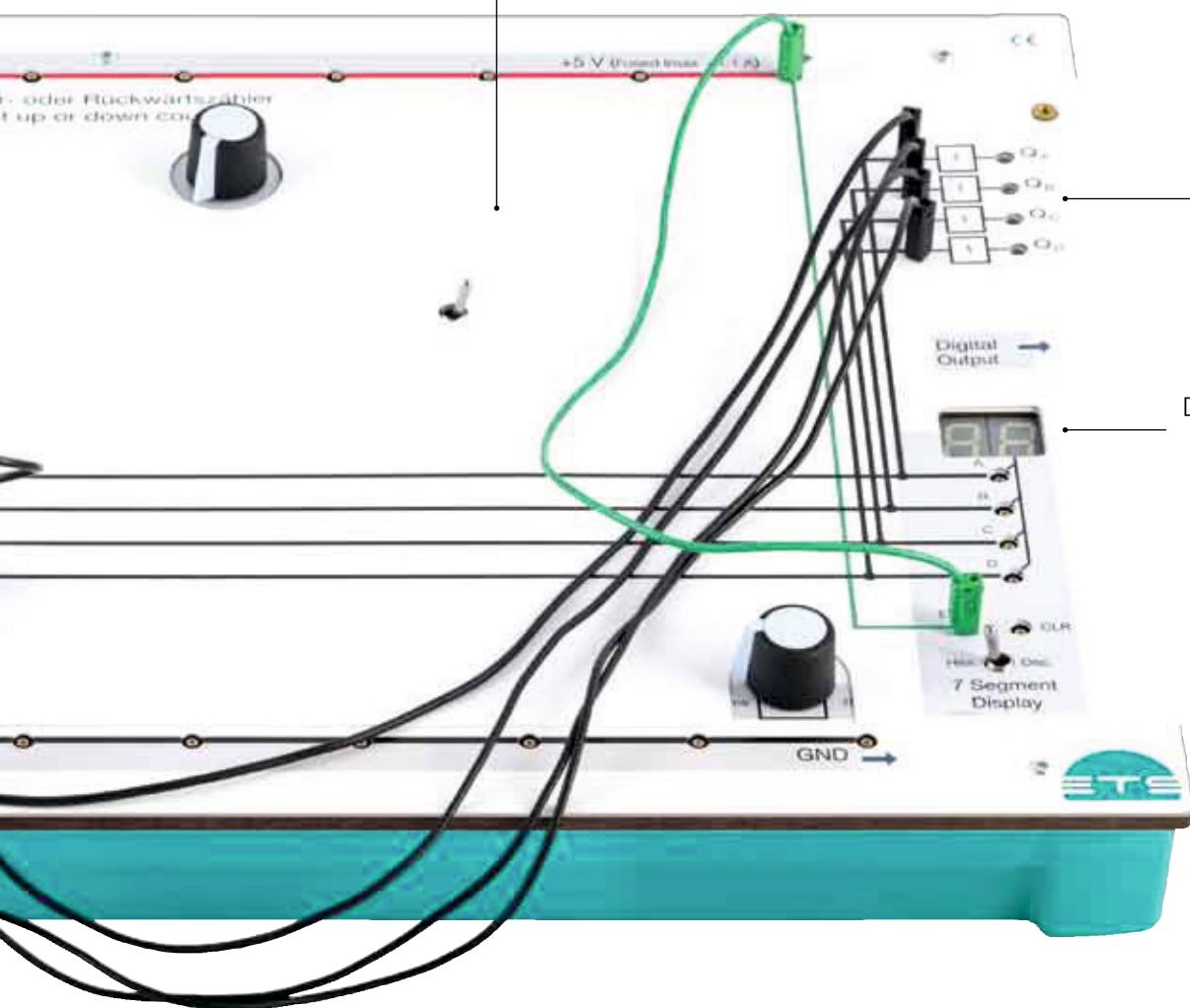

Display binary

Display hexadecimal or decimal

Digital Technology

Basic digital technology trainer – overlay masks

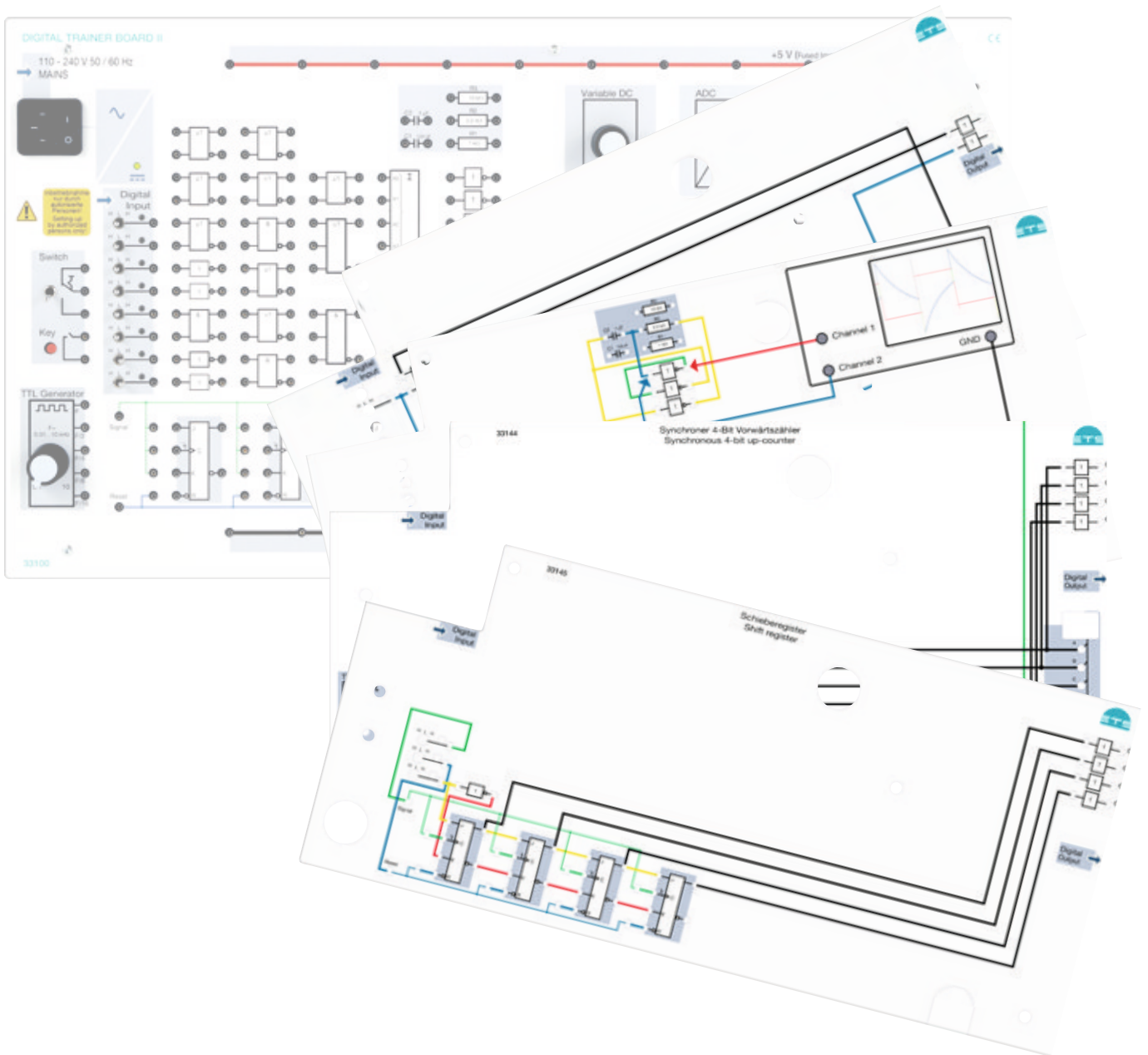

No.	Designation	Order No.
1	set of overlay masks – digital technology	33105

courseware



1

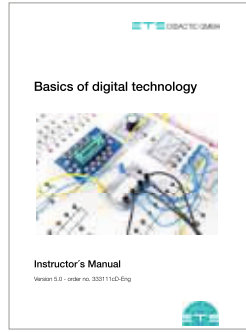

2

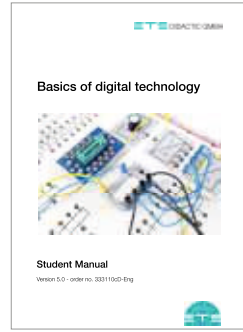

3

Printed and digital

Manual content

- › comparison analog technology – digital technology
- › Logical basic connection
- › compound basic operations
- › TTL circuits in practice
- › The laws of switching algebra
- › Development of digital circuits
- › analysis of logical switching networks
- › Toggle stages, counter circuits
- › shift registers, memory registers
- › codes and code converters
- › computing circuits
- › A/D converters – D/a converters
- › Multiplexer – demultiplexer
- › application examples

TECHNOCard®

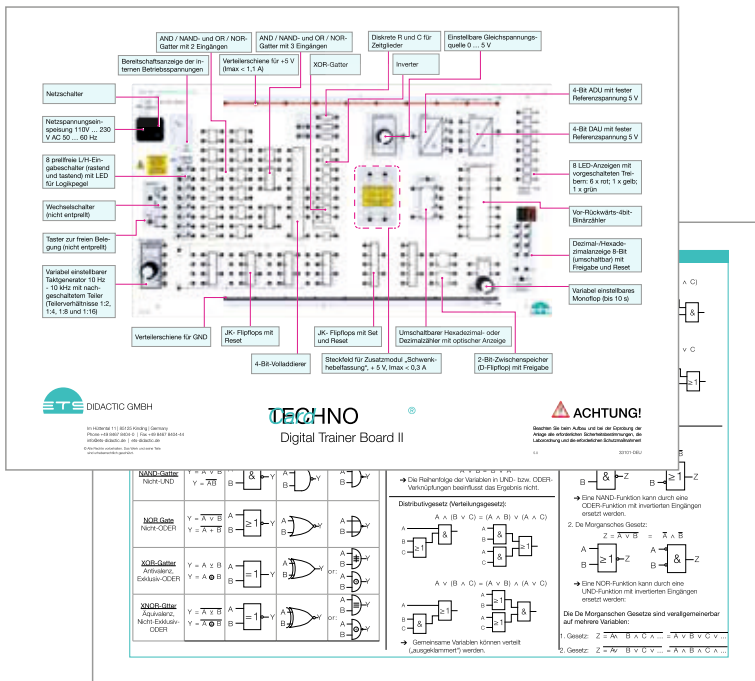

4

No.	Designation	Order No.
1	set of ET's ring binders	91903
2	Basics of digital technology - instructor's Manual	33111cD-Eng
3	Basics of digital technology - student Manual	33110cD-Eng
4	TEchnocard - Digital Trainer Board ii	33101-Eng



μ-TrainEr

Basics of digital technology with ics

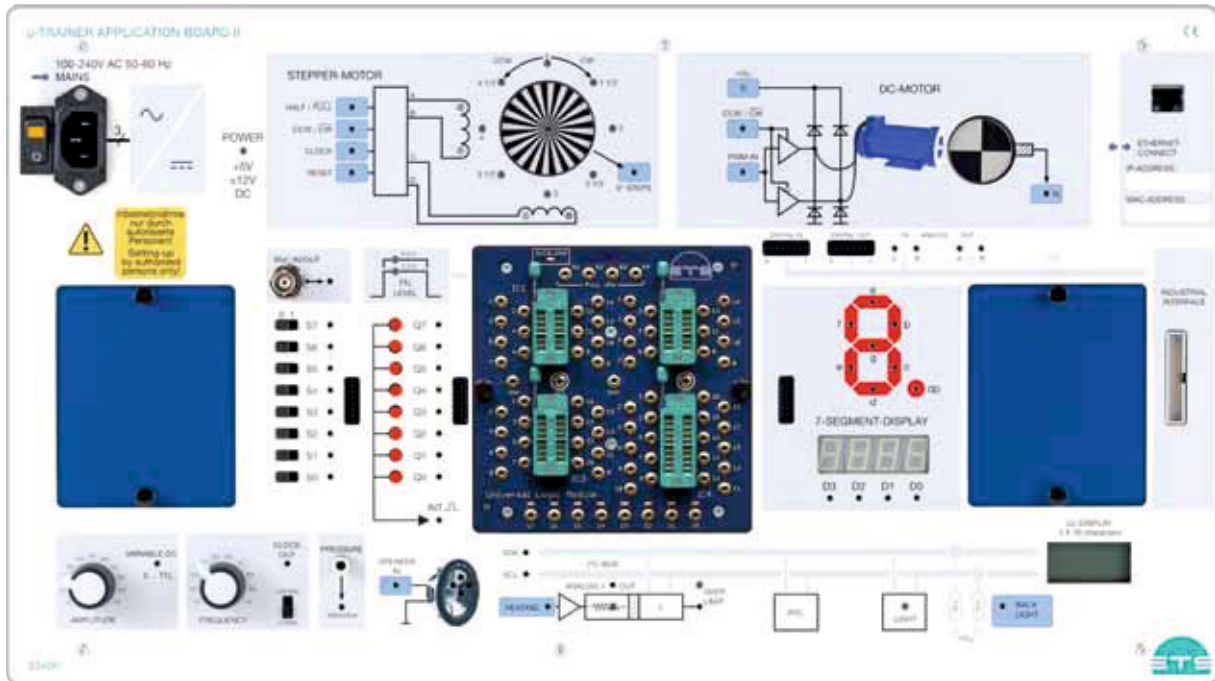

1

Learning objectives

- › Methods of digital circuit analysis
- › Methods of digital circuit synthesis
- › Logic circuits in practice
- › construction of circuits with ics
- › characteristics of circuits
- › Measuring equipment and methods
- › complex logic circuits and converters

Technical data

- › computer interface via Ethernet
- › connection via 2mm plug-in system or bus connector (8-pin 1:1, ribbon cable)
- › Power supply: 110 ... 240 V ac 50 ... 60 hz
- › internal operating voltage: 3.3 V; 5.0 V; +/-12 V
- › Central on/off switch
- › Logic level: 3.3 V or 5.0 V
- › Dimensions: 532 x 297 x 85mm
- › Device form: console housing

μ-Trainer application Board ii equipped with 33406 Universal Logic Module

No.	Designation	Order No.
1	μ-Trainer application Board ii	33400

courseware



Printed and digital

Manual content

- > introduction of digital technology
- > Basic logic circuits
- > Logic circuits in practice
- > Boolean circuit algebra
- > De Morgan's laws
- > circuit synthesis
- > Disjunctive normal form
- > conjunctive normal form
- > adders and subtractors
- > comparators
- > Flipflops
- > Monostable flipflops
- > Astable flipflops
- > counter circuits
- > shift registers
- > Multiplexers and demultiplexers
- > analog-to-digital converters
- > Digital-to-analog converters

TECHNOCard®

4

No.	Designation	Order No.
1	set of ET's ring binders	91903
2	Fundamentals and basic circuits of digital technology - instructor's Manual	33121cD-Eng
3	Fundamentals and basic circuits of digital technology - student Manual	33120cD-Eng
4	TEchnocard - Digital technology on the μ-trainer application Board	33103-Eng





The diagram illustrates the setup for the TECHNOCard application board. It features several key components and their connections:

- Motor:** A blue motor is connected to a power supply and a control circuit.
- Fan:** A cooling fan is connected to a power supply and a control circuit.
- Sensors:** Various sensors are connected to the board, including a photo eye and a temperature sensor.
- Application Board II:** The central component, a blue PCB with various components and connectors.
- Display:** A red LED display showing the number '8'.
- Control Panel:** A panel with various buttons and switches.

The diagram includes detailed wiring diagrams and labels for each component. The text 'TECHNOCard' and 'Nutzung des Application Board II' is prominently displayed at the bottom of the diagram.

The back panel of the TECHNOCard application board features several ports and connectors:

- Power Connector:** A large black connector for power supply.
- Serial Port:** A DB-9 serial port connector.
- USB Port:** A USB connector for data transfer.
- Other Connectors:** Various other connectors for sensors and actuators.

A blue cable is plugged into the USB port. The board is mounted on a white panel, and a black keyboard is visible in the foreground.

MoDULE

Prototype module

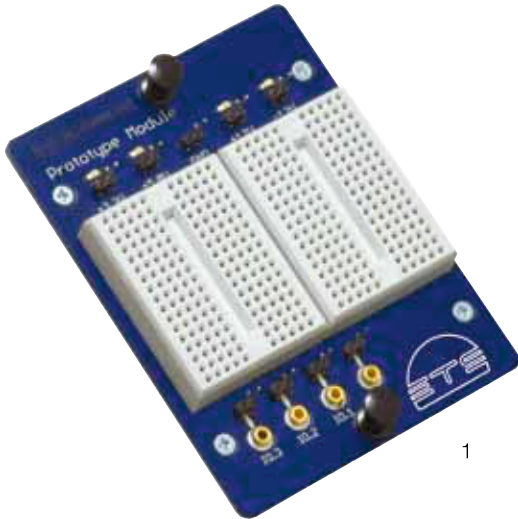

1

Technical data

- › 2 breadboard pads 10 x 17 pin
- › 4 control inputs with 2mm sockets and pin
- › 4 operating voltage outputs on pin: 3.3 V, 5.0 V, +12 V and -12 V
- › operating voltage 3.3 V und 5.0 V short-circuit proof, $i_{nom} \leq 1.3 \text{ A}$
- › operating voltage +12 V and -12 V short-circuit proof, $i_{nom} \leq 0,3 \text{ A}$ (continuous load)
- › indication of operational readiness via LED
- › Dimensions 78 x 95 x 32mm



2

a useful accessory for the prototype module is the 33391 Breadboard Wiring Set

No.	Designation	Order No.
1	Prototype module	33410
2	Breadboard Wiring set	33391

The "prototype module" is a self-contained extension module for the μ training system. it allows the additional and free construction of digital circuits basedon a breadboard system.

Universal logic module

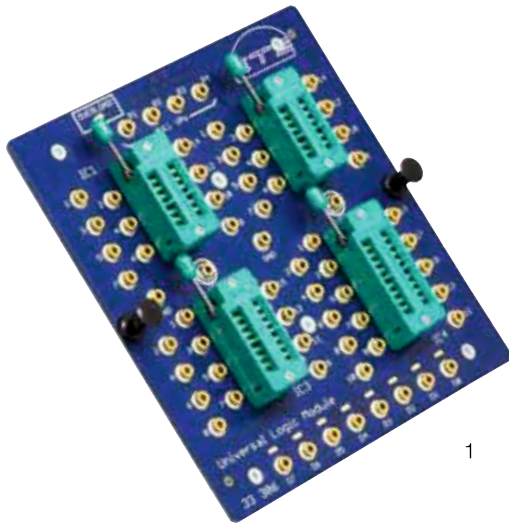

1

Technical data

- › 4 ZiF socket, all pins freely connectable via 2mm sockets, of which
 - 2 x ZiF socket 14 pin
 - 1 x ZiF socket 16 pin
 - 1 x ZiF socket 20 pin
- › 8 x LED with separate inputs for display of logic levels; buffered
- › 4 x Pull-up 10 k Ω
- › Logic level: +5 V TTL
- › operating voltage short-circuit proof, $I_{nom} \leq 1.3$ A
- › overload indication with bright blue LED
- › Dimensions 120 x 125 x 30mm



2

construction element set in a sturdy plastic assortment case with 18 compartments and 26 circuits.

No.	Designation	Order No.
1	Universal Logic Module	33406
2	Basic set Logic ics	33390

The "Universal Logic Module" (33406) is a self-contained extension module for the μ c training system and is used for the investigation and free experimentation with logic circuits.

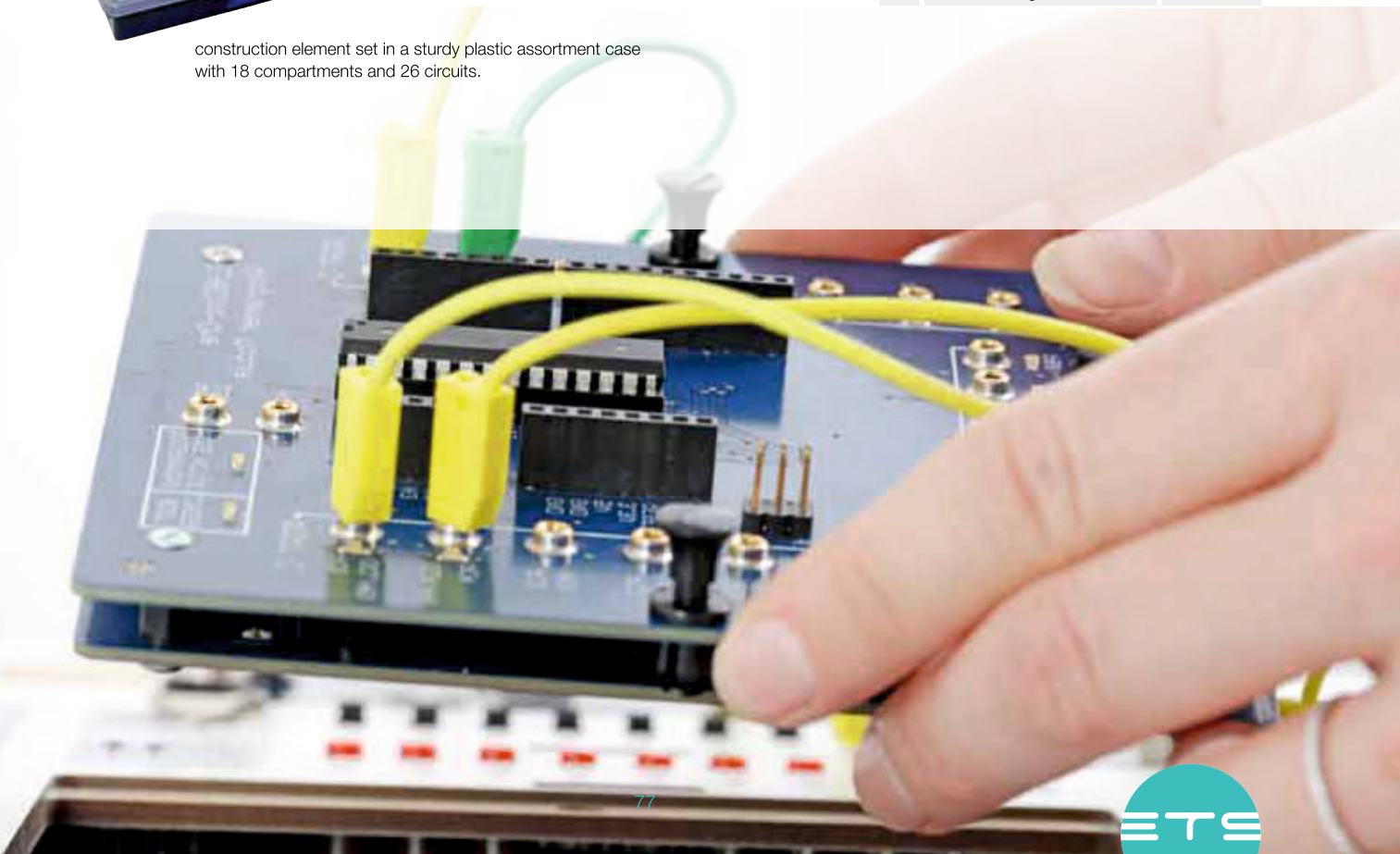

EXPansion MoDULEs

8 Bit aDU module

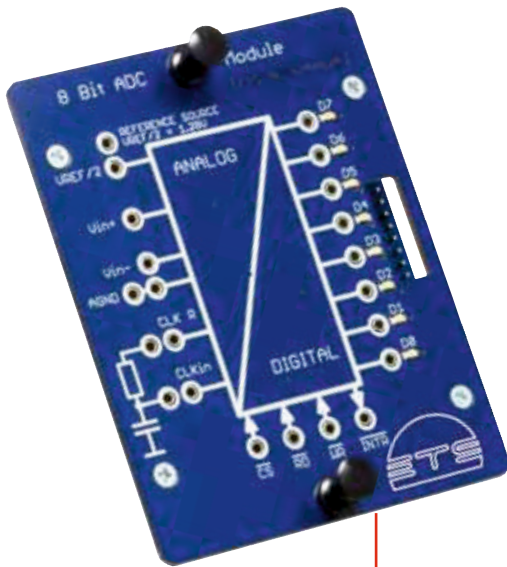

Das „8 Bit aDU module“ is a self-contained extension module for the µc-training system.

The 8 bit analog to digital converter can be operated with microcontroller control and also with static control signals to investigate the operation of an analog to digital converter.

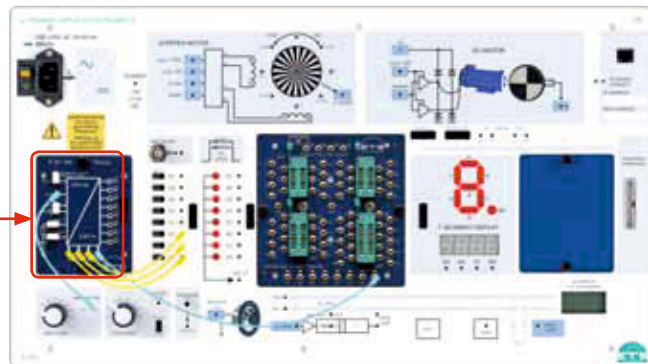

Technical data

- › 1-channel aD converter
- › reference voltages 2.56 V, Vcc internal or external up to maximum 5 V
attention: The reference voltage level to be fed in is $0.5 \times V_{REF}$!
- › Differential input with 2mm sockets
- › 8 outputs with 2mm sockets and bus connector
- › 4 control inputs and outputs with 2mm sockets
- › Logic level: +3.3 V or +5 V according to programmer or logic module specification
- › Dimensions 78 x 95 x 32mm
- › with manual and cD-roM, incl. example programs of the controller

No.	Designation	Order No.
1	8 Bit aDc module	33407

8 Bit DaU module

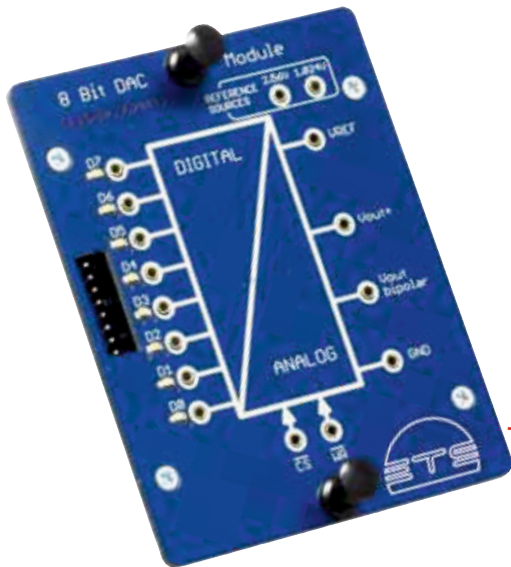

The „8 Bit DaU module“ is a self-contained extension module for the µc trainings system.

The 8-bit digital-to-analog converter can be operated with microcontroller control and also with static control signals to study the operation of a digital to-analog converter.

1

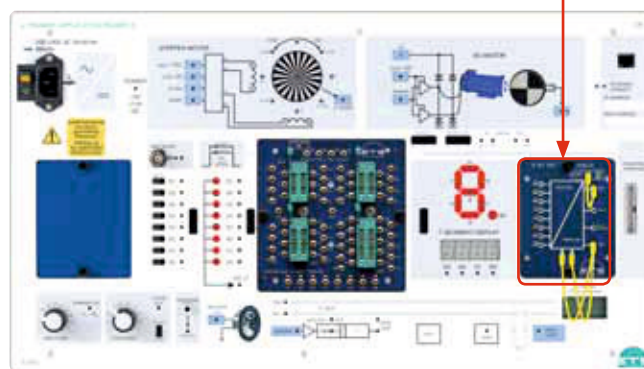

Technical data

- › 1-channel Da converter
- › reference voltage 2.56 V, 1.024 V or external up to maximum 4.2 V
- › 8 inputs with 2mm sockets and bus connectors
- › 1 output with 2mm socket unipolar
- › 1 output with 2mm sockets bipolar
- › 2 control inputs with 2mm sockets
- › Logic level: +3.3 V or +5 V according to programmer or logic module specification
- › Dimensions 78 x 95 x 32mm
- › with manual and cD-roM, incl. example programs of the controller

No.	Designation	Order No.
1	8 Bit DaU module	33408

MoBiLE sys TEMs

Experiment at any place, at any time



1 and 2

We also supply our boards permanently installed in a lockable experimental case with removable lid, which provides space for the corresponding accessory sets.

Due to its robust yet lightweight aluminum outer shell, it is ideally suited for transport and at the same time allows safe and dust-free storage of the training systems.

No.	Designation	Order No.
1	Experimental case (without equipment)	91801
2	Experimental case with Electronic circuit Board ii and set of electrics/electronics components	3200-V2-Z03





MEasuring DEVICES

Digital multimeter, analog multimeter



1



2

3

Professional digital multimeter

The multimeter for training

The professional multimeter is designed to measure Dc & ac voltages up to 1000 V in the measurement category ca T III 600 V bzw. ca T IV 300 V safely according to the IEC/EN61010-1 specifications.

The multimeter, equipped with a mechanical protection against incorrect operation, has a large, high-resolution display with bar graph and an AutoPowerOff function to save batteries.

ideal for laboratory use in school and training.

Functions

- › mechanical malfunction protection
- › ac and Dc voltage up to 1000 V
- › ac and Dc current up to 10 a
- › resistance measurement 30 MΩ and continuity test
- › Frequency and capacitance
- › Temperature with PT-100 probe
- › Diode test and duty cycle
- › automatic range selection
- › MaX/Min and Data hoLD
- › autoPoweroFF

Analog multimeter for training

The multimeter meets the requirements for teaching and professional training and is also suitable for calibration and revision work in service.

Funktionen

- › Voltage measurement 0...100/300 mV/1 V=0 ... 3/10/30/100/300 V=/~
- › current measurement 0 ... 100 ma/1/10/100 ma/1/3 a = ~
- › optional setting: **zero left/center**
- › Excellent overload capability, automatic battery shutdown
- › accessories

No.	Designation	Order No.
1	Digital multimeter	90600
2	storage case "Universal" for eight measuring instruments	90275
3	analog multimeter	90200

oscilloscopes

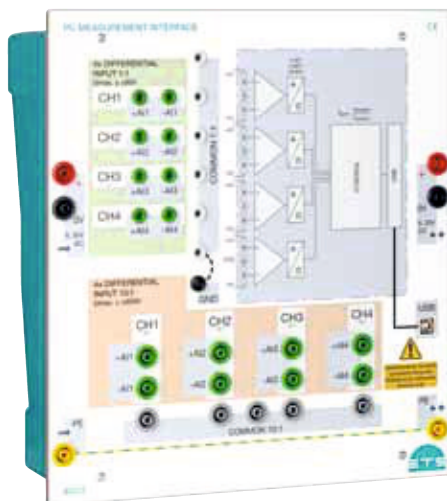

1



2

PC Measurement Interface
For detailed info on page 32-30.

- Color digital oscilloscope 30MHz
- › 125 Msamples/s per channel
 - › signal memory 10.000 x 8 bits per channel
 - › 2 channels
 - › Deflection coefficients 2 mV/Div to 10 V/Div, time base 5 ns/Div to 100 s/Div
 - › UsB interface incl. software and driver
 - › color display

No.	Designation	Order No.
1	Pc Measurement interface	90272
2	color digital oscilloscopes 30Mhz	90266



Stay connected with us on social media

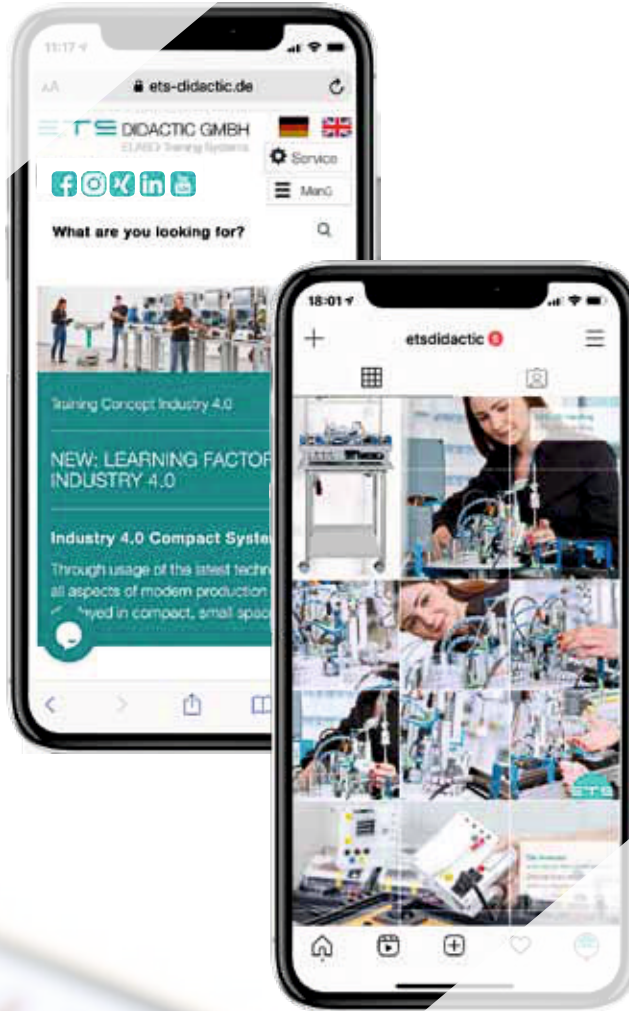

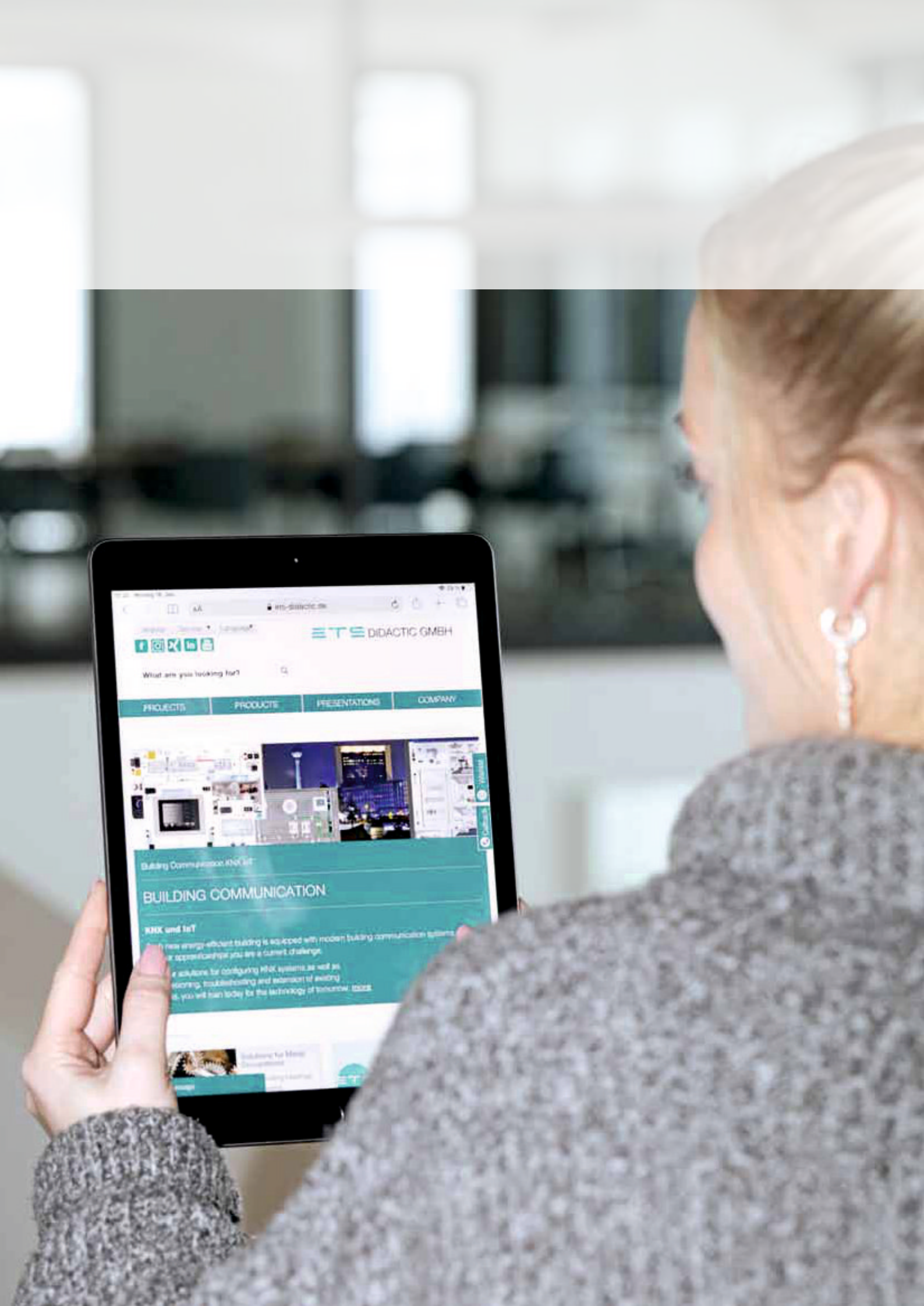

www.ets-didactic.de

ETS DIDACTIC GMBH

What are you looking for?

PROJECTS PRODUCTS PRESENTATIONS COMPANY



Building Communication (KNX) IoT

BUILDING COMMUNICATION

KNX and IoT

A new energy-efficient building is equipped with modern building communication systems. For operational purposes you are a current challenge. Our solutions for configuring KNX systems as well as monitoring, troubleshooting and extension of existing systems will train today for the technology of tomorrow. [More](#)

Building for Smart Communication

QUaLiTy is ThE MEAsUrE oF aLL sUccEss

inspiring Technologies

ETS DIDACTIC GMBH is a symbol of high quality and outstanding flexibility. This means that ETS DIDACTIC products are convertible, they can – thanks to the modular conception and the versatile range of accessories – be quickly and efficiently matched to changed requirements and extended nearly without limits.

our high quality standards refer not only to the products from ETs DiDac Tic, but especially also to the quality of the training that customers achieve thanks to the use of ETs DiDac Tic products. and in this, we also include the process quality: ETs DiDac Tic supports procedures during the training that are as problem-free as possible.

The solutions offered by ETS DIDACTIC can be matched to individual customer requirements to a great extent. customers of ETs DiDac Tic are supported and accompanied in the successful implementation of their training objectives by a comprehensive range of services.





PLEasE conT ac T Us

We are always ready to assist you



Ellen schönberger
service center



Monday to Friday from 7.45h to 16.30h

Phone: +49 8467 / 8404-0

email: sales@ets-didactic.de

We accompany you and are at your side with active advice. Whether you need information, or some advice in advance of making an investment, or have questions regarding the daily use of the products:

Contact us – we are ready to assist:

ETs DiDac Tic gMBh
service-center
im hüttental 11
85125 Kinding / germany

Phone +49 8467 8404-0
Fax +49 8467 8404-44

sales@ets-didactic.de
www.ets-didactic.de



Customer-oriented solutions

- › Presentation, product demonstrations and on-site consultancy
- › support in the selection of educational systems according to the syllabus requirements
- › Matching of the training systems to customer requirements
- › Working out room concepts
- › Designing ergonomic workstations

Experience

- › comprehensive range of innovative products
- › systems and solutions from our own (in-house) production
- › Development and design, technical training systems
- › Quality right from the consultancy up to delivery and onward
- › Trainer workshops / in-house training / Webinars
- › references world-wide
 - industrial educational institutions
 - Vocational schools / technical schools
 - chambers of crafts
 - Technical colleges / Universities

We support you

- › installation and commissioning of the systems on-site
- › Technical support
- › Warranty and repairs
- › instruction and training
- › Further education, training, seminars
- › comprehensive product documentation
- › courseware for instructors and trainees

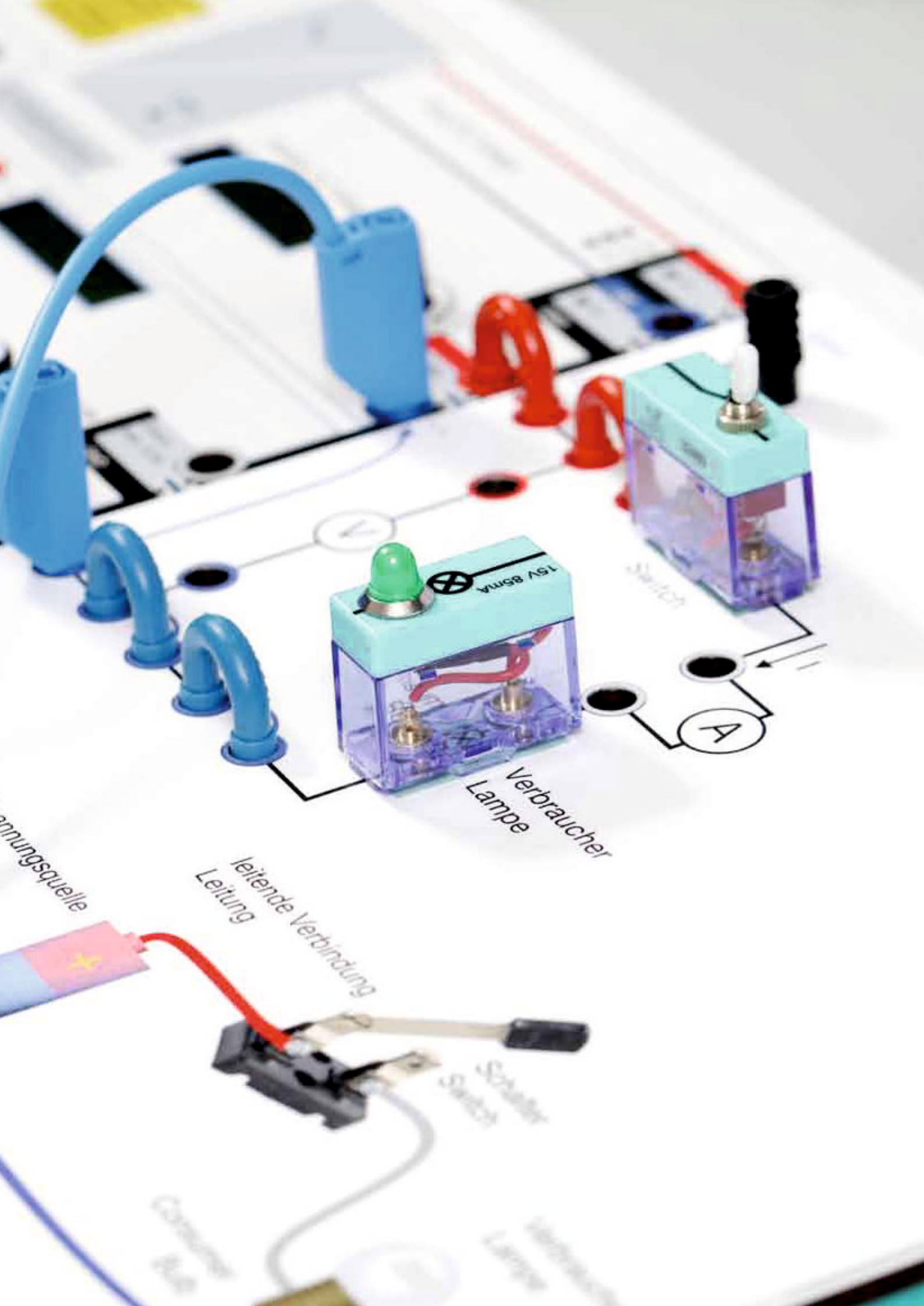

Spannungsquelle

leitende Verbindung

Verbraucher
Lampe

Schalter



A

Schalter

yoUr EnQUIry

We are always ready to assist you

Via the following QR code you are welcome to download the enquiry form and send it filled out via e-mail or fax to ETS.



Qty	Designation	Order No.	Qty	Designation	Order No.
	Circle of electronics			appt/rapid case with electronic Board 1st set	30000-204
	Handbook Instructor's Manual, incl. CD	32125CD-wEG		Components kit for electronics	32000D-wEG
	Handbook Student Manual, incl. CD	32125CD-wEG		Handbook Instructor's Manual, incl. CD	32000D-wEG

ETS DIDACTIC GMBH	CD	32000D-wEG
32	32001-wEG	
	32002	
	32003	
	32004	
	32005	
	32006	
	32007	
	32008	
	32009	
	32010	
	32011	
	32012	
	32013	
	32014	
	32015	
	32016	
	32017	
	32018	
	32019	
	32020	
	32021	
	32022	
	32023	
	32024	
	32025	
	32026	
	32027	
	32028	
	32029	
	32030	
	32031	
	32032	
	32033	
	32034	
	32035	
	32036	
	32037	
	32038	
	32039	
	32040	
	32041	
	32042	
	32043	
	32044	
	32045	
	32046	
	32047	
	32048	
	32049	
	32050	
	32051	
	32052	
	32053	
	32054	
	32055	
	32056	
	32057	
	32058	
	32059	
	32060	
	32061	
	32062	
	32063	
	32064	
	32065	
	32066	
	32067	
	32068	
	32069	
	32070	
	32071	
	32072	
	32073	
	32074	
	32075	
	32076	
	32077	
	32078	
	32079	
	32080	
	32081	
	32082	
	32083	
	32084	
	32085	
	32086	
	32087	
	32088	
	32089	
	32090	
	32091	
	32092	
	32093	
	32094	
	32095	
	32096	
	32097	
	32098	
	32099	
	32100	

electrical engineering / electronics / Digital technology – The basics in detail

ETS DIDACTIC GMBH
 Im Hahnenst 11
 85125 Kinding | Germany
 Phone: +49 8907 8804-0
 Fax: +49 8907 8804-44

We would like:
 Contact by telephone _____
 Consultation on site _____
 Information on seminars _____
 Receive an offer about _____

_____ Name, Function
 _____ Company, Institution / Subunit
 _____ Street, P.O. box
 _____ Zip code, city
 Telephone _____
 e-Mail _____

Qty	Designation	Order No.	Qty	Designation	Order No.
	Fundamentals of electrical engineering			Handbook Student Manual, incl. CD	32004D-wEG
	MicroCircuit Board I	32000		TechnoCard® - electronics Basics	32031-wEG
	MicroCircuit Board incl. assembly kit 22223	32000-22223		Handbook of electrical engineering/electronics	32000D-wEG
	Device for electronics	32003		Set of ETS engineering	91933
	DC Amplifier 5V / 17W	32005		DC technology	
	Three phase current symmetrizer AC/3V	32011		Handbook Instructor's Manual, incl. CD	32125CD-wEG
	3-Phase Board	32006		Handbook Student Manual, incl. CD	32125CD-wEG
	Diode's overvoltage protector 1.5A format	32040		TechnoCard® - electronics Basics I	32031-wEG
	Diode's overvoltage protector 2.5A format	32040		DC technology	
	Diode's overvoltage protector 1.5A format	32140		Handbook Instructor's Manual, incl. CD	32125CD-wEG
	Diode's overvoltage protector 2.5A format	32150		Handbook Student Manual, incl. CD	32125CD-wEG
	Micro Board Case with Device set 32002	32000-204		Handbook of electrical engineering/electronics	32000D-wEG
	Device Set Basics	32002		Handbook Instructor's Manual, incl. CD	32124CD-wEG
	Handbook Instructor's Manual, incl. CD	32000D-wEG		Handbook Student Manual, incl. CD	32125CD-wEG

Continuation - see page 2





Scarica il catalogo completo



Cataloghi digitali, alberi felici:
scegli **Abintrax** che con **mydidactstore**,
abbraccia la sostenibilità!

Concessionario



Abintrax s.r.l.
Via Marina del Mondo, 62 | 70043 Monopoli (Ba) Italy
tel. +39 080 2149700 | www.abintrax.com | info@abintrax.com

www.mydidactstore.it