



Sicurezza elettrica degli impianti elettrici

Tecniche di corretta installazione e misure protettive di sicurezza



SAFETY OF ELECTRICAL INSTALLATIONS AND DEVICES

Mains Systems And Protective Measures

another way to care

Visita il nostro store



www.mydidactstore.it

 **Didact**
STORE

Mains systems and Protective Measures

Testing Protective Measures

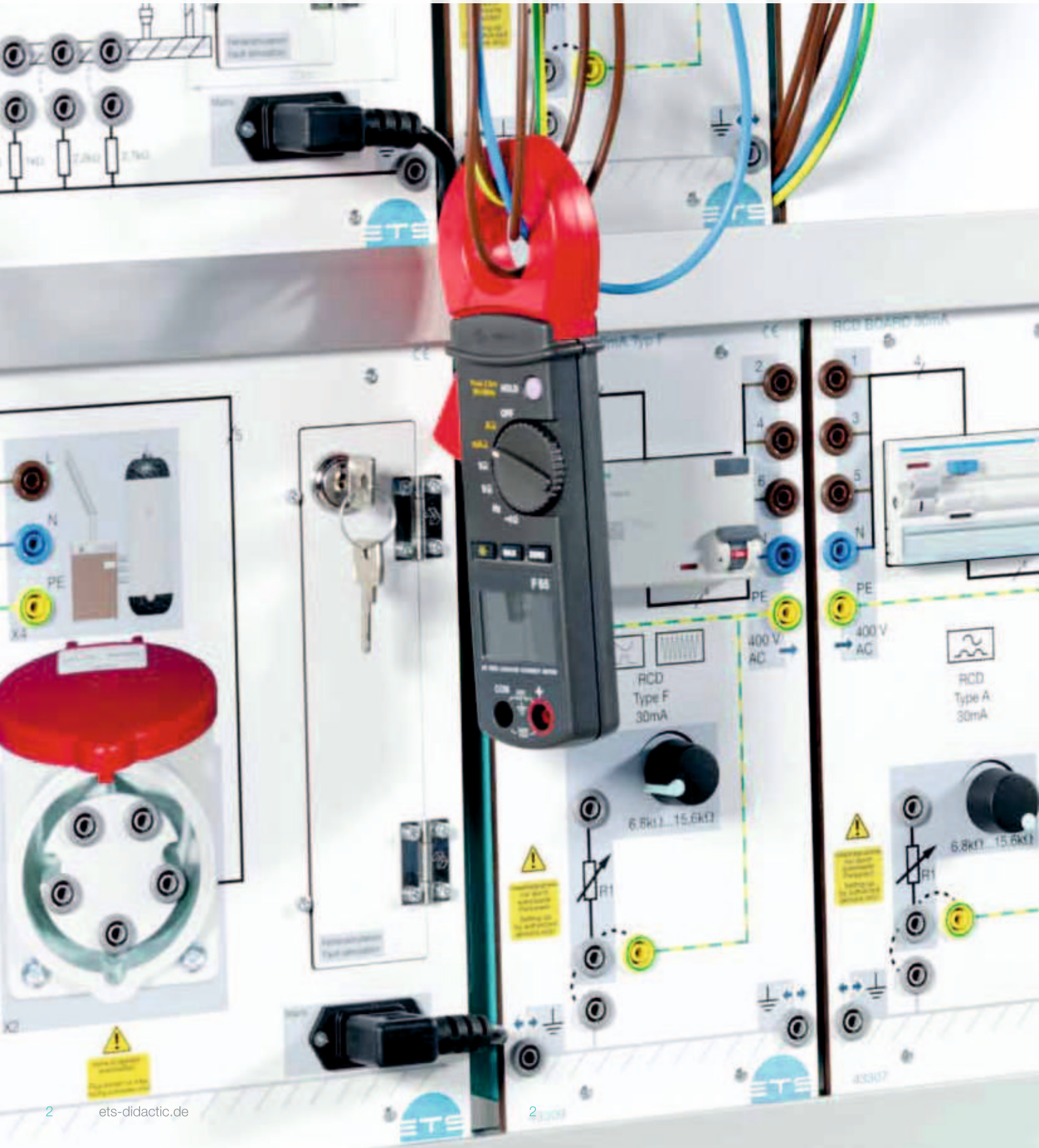

contents

didactic solutions

General Information

editorial	4
visit ets in the valley of river altmühl.....	6
approach and room concept.....	8
People and technology.....	10
Workshops with ets	12
the ets training concept	14

Mains Systems and Protective Measures

electrical protective measures.....	18
electrical protective measures – courseware	20
Mains systems and protective measures.....	22
Main distribution Board	24
rcd circuit breaker	26
customer plant.....	30
training package tP 26.1.2	34
insulation monitoring.....	36
Mains systems and protective measures – courseware	38
vde 0100 / electric Main connection	40
energy supply systems – courseware	42

Loads on the Neutral Conductor

Load on the neutral conductor.....	46
Power line Harmonics Board ii.....	48
Load on the neutral conductor – courseware	56

Testing Electrical Devices

testing of electrical devices according to din vde0701-02	60
Protective measures – courseware.....	62

Measuring and Test Instruments

digital multimeter, analog multimeter.....	70
voltage tester, direction of rotation tester	72
leakage current clamp meter	74
installation tester.....	76
appliance tester in Proactive case for training.....	80
3-phase main and power supply analyzer	82
thermal imager.....	84

Information and Consultation

stay connected – with us on social Media.....	86
didactic solutions from ets	88
Quality is the Measure of all success	90
Please contact us	92
your enquiry	94

PeoPle and tecHnology – a Perfect Match

technology to inspire you: understanding – comprehending – applying

ETS DIDACTIC is your partner for in-house and institutional education and training in the professional fields of electrical engineering and metal technology.

topics such as industry 4.0, electrical engineering, power electronics, pneumatics, drive technology, automation technology, sensor technology, bus systems, mechatronics, transmission technology and the complete scope of building systems engineering including renewable energies are presented as a training system. With the help of well thought-out learning-oriented hardware and accompanying courseware, the specialist skills are quickly learned, grasped by hands and lead to didactic learning success in a goal-oriented manner.

the service spectrum of ETS DIDACTIC ranges from the provision of didactic hardware, courseware and software to the planning and equipping of the complete training rooms. ets meets all requirements with practice-oriented workshops on the complete spectrum of technical professions for lecturers, trainers and instructors in a specially built modern training center or online.

vocational schools, training centres of the icc, chamber of crafts or the industry, polytechnics and universities are among the long-standing customers of ETS DIDACTIC.



Welcome to ets didactic

ETS DIDACTIC is the pioneer and market leader in the development, manufacture and sales of electrical, automation and mechatronic workstations for training and instruction.

ETS DIDACTIC counts among the leading international manufacturers in the market environment. Located in Kinding, in the beautiful natural reserve of altmühlthal – high-quality products and solutions are developed and manufactured for you.

In the training centre in Kinding, the focus is on the practical application of the systems and fast learning of new technologies by the customers.

The knowledge, experience and the above-average personal involvement of the motivated employees of ETS DIDACTIC are vital factors for the company's efficiency.



Sven Urban
Managing Director



Udo Urban
Managing Director
(Founder)



Made in gerMany

visit ets in the valley of river altmühl

Welcome to Germany - Bavaria

the altmühltal nature Park is one of the largest in germany and offers a thousand ideas for families, history fans, cultural discoverers and nature lovers.

you can travel to our workshop in Kinding-Haunstetten by train. the regional train station Kinding/altmühltal is located directly on the ice route between nuremberg and Munich. the regional express trains of deutsche Bahn stop every two hours. the journey from Kinding to ingolstadt takes 17 minutes, to Munich 1 hour 15 minutes and to nuremberg only 27 minutes.

Local cab companies are available to take you from Kinding to Haunstetten. We will be happy to assist you with the organization.

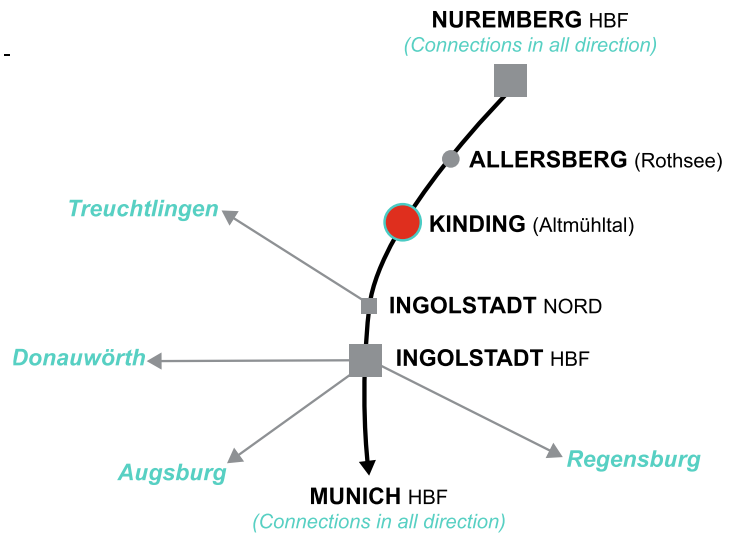

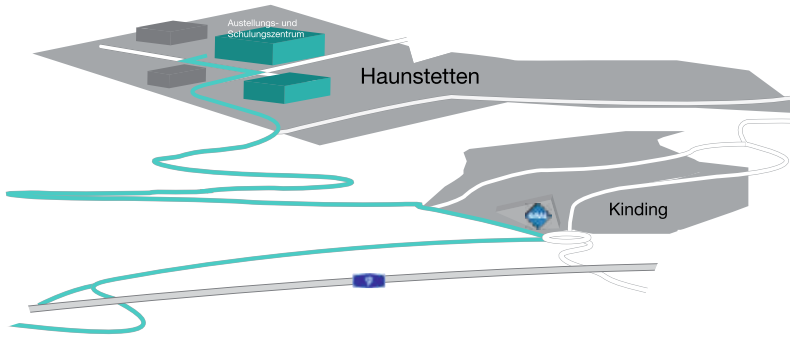

Kloster Weltenburg



naturpark altmühltal

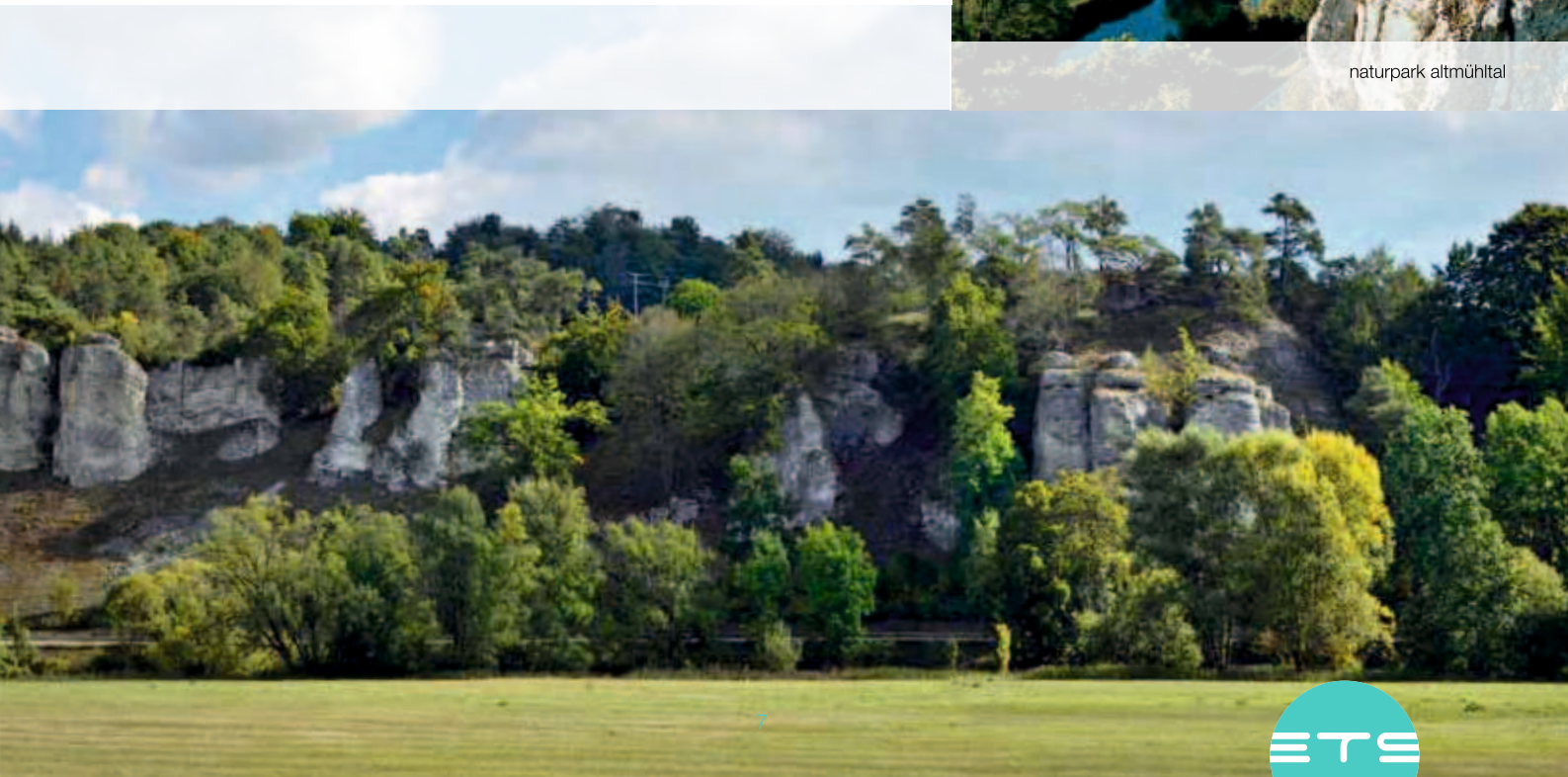

aPProach and rooM concePt

to plan a custom-made room concept with you, we proceed in the following steps:

- › a good room concept is based on professional advice. the technical consultants of ets didactic are pleased to support you in the local planning phase. Benefit from their technical expertise and experience.
- › Planning a room concept is more than selecting the furniture. each room concept is adapted to and developed for the local requirements of the customer.
- › taking into account the learning contents an equipment list can be set up. as soon as the extent is defined, the storage equipment is optimised and designed.



analysis

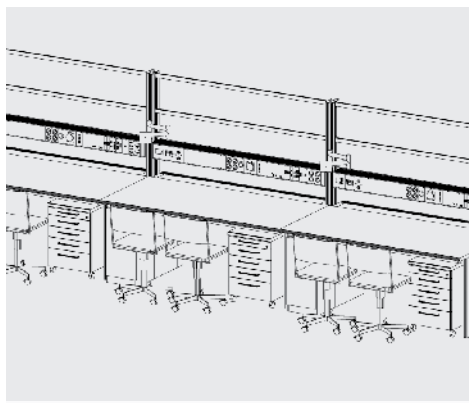

conception



consulting / Planning

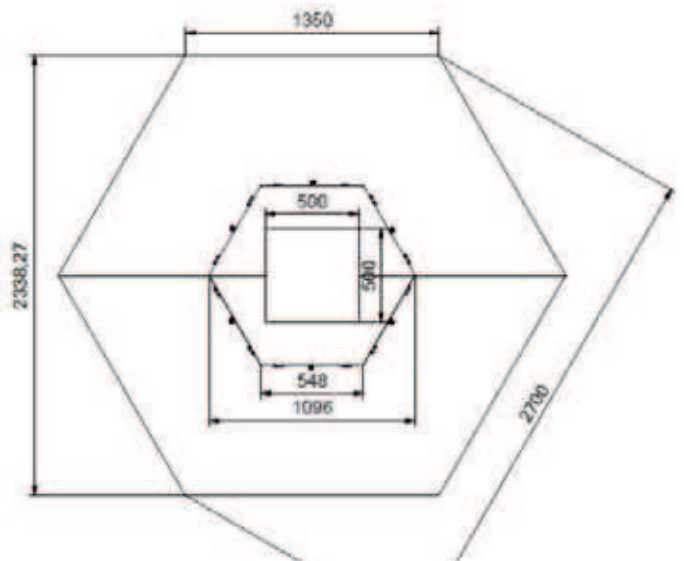

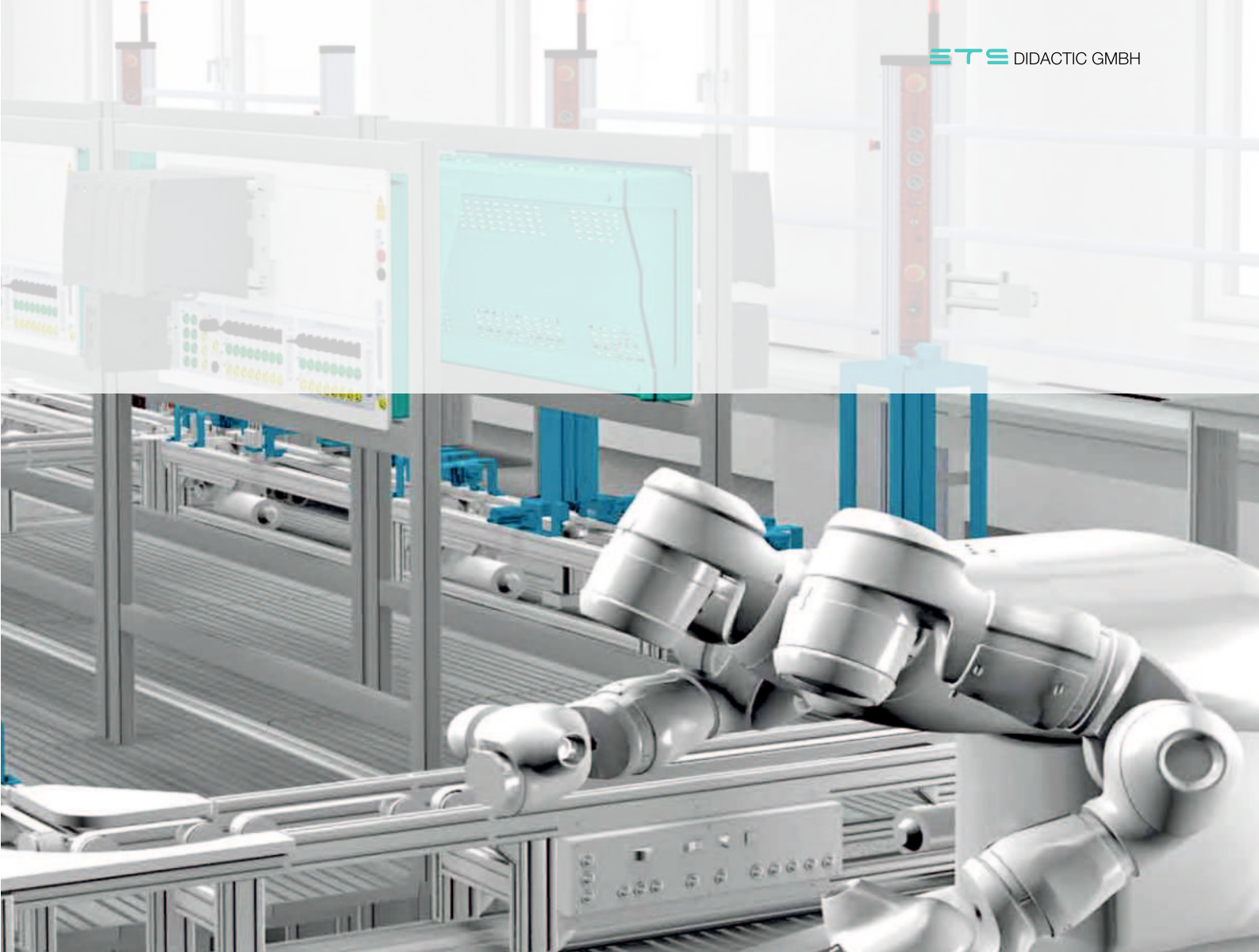

design / construction



Workshops



application

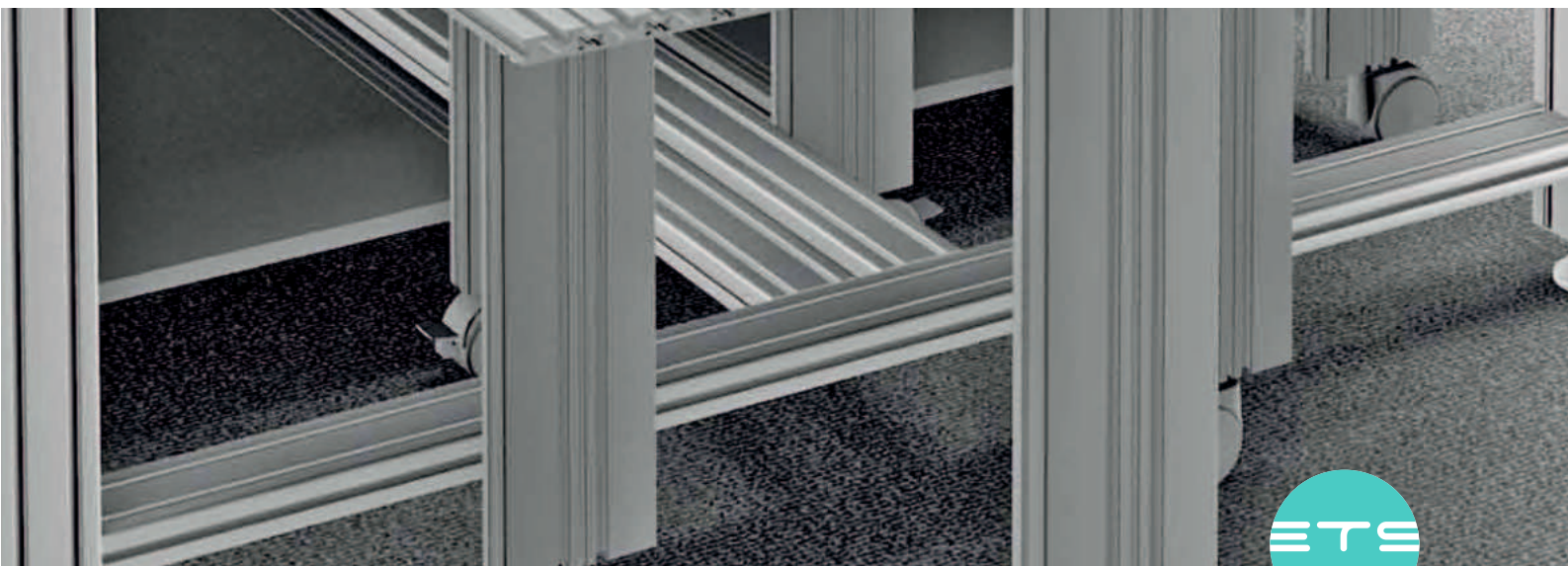

PeoPle and tecHnology – a Perfect Match

didactic and technology result in the ets-concept

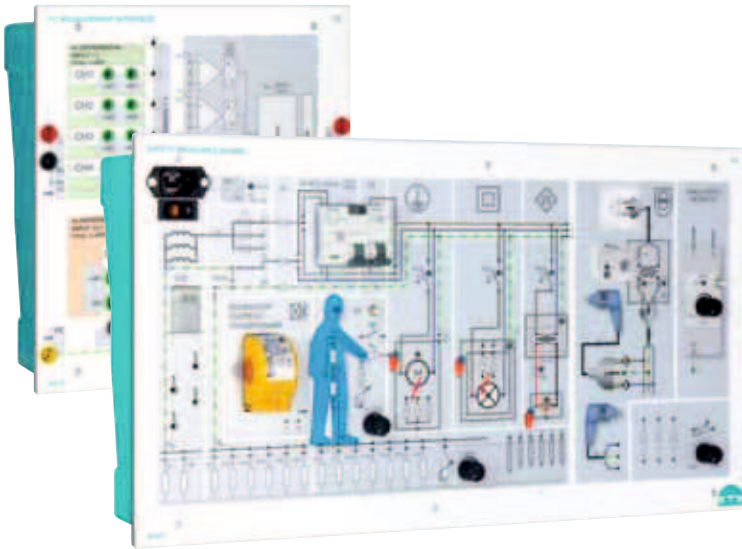

compact Boards

- } their didactical concept makes our training systems in a4 format outstanding.
- } the photorealistic design of their front panels with graphics, pictures, connection details or warning messages assist and guide the experiments - cognitive didactics. due to the graphics, users comprehend and remember the technologies more easily.
- } the systems can be mounted in an a4 frame or placed directly on a table.

experimental Boxes

- } construct your own experiments. Beside the wiring, the arrangement of the components is focused. With the experimental boxes it's possible to practice basic circuits as well as complex installations
- } always close to practice, fast and safe!
- } Wide range of industrial components.



Bst[®]-Buildingsystemstainer

› the Buildingsystemstainer[®] is a mobile training system that can be taken from one classroom to another and then is ready for use within some minutes.

› Beside our laboratory equipment with the experimental boards, these flexible training systems represent an independent product line covering many topics as e.g. the vde protective measures according to vde 0100 or the KNX building communication sector, communications technology and renewable energies, smartBuilding and internet-of-things.

› Boards can also be integrated in the Buildingsystemstainer[®]

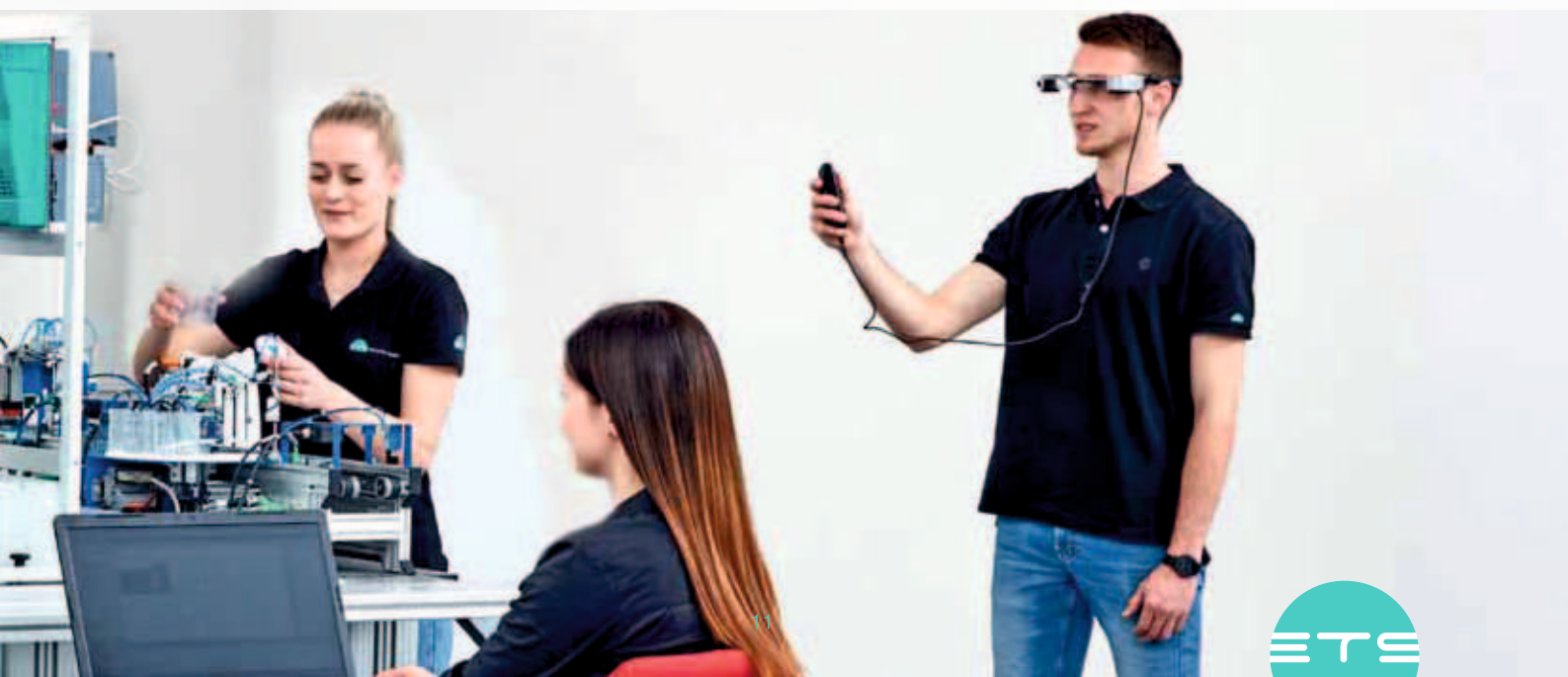

Workshops With ets

always up to date – training at the Highest Level



) Train the trainer – workshops for teachers, trainers and lecturers in the field of electrical engineering, mechatronics and metal technology.

) Learn more about the management and the application of various technologies with the support of the ets trainers. find out more about the didactic concept and learn to teach the material quickly and safe.

) ETS offers a perfect seminar for all groups of products and topics of technical education. scan the Qr code to subscribe in a workshop:



ets-didactic.de/hp584/Workshops.htm



fast and safe into new technologies

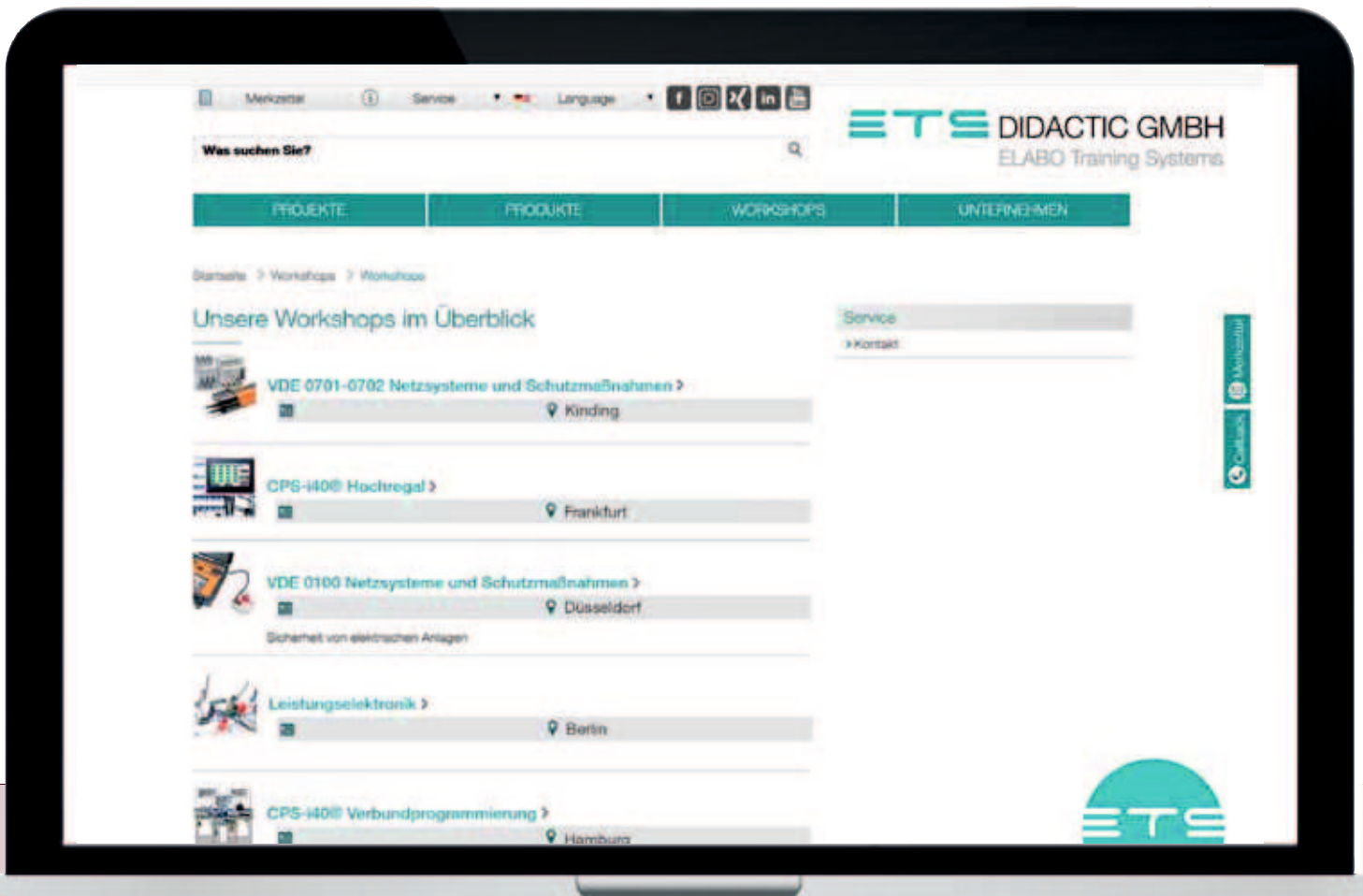

the ets training concept

innovative Hardware / Perfect courseware

- structure of the Manuals
- › ringbinder principle
 - › dividers
 - › incorporation of personal documents

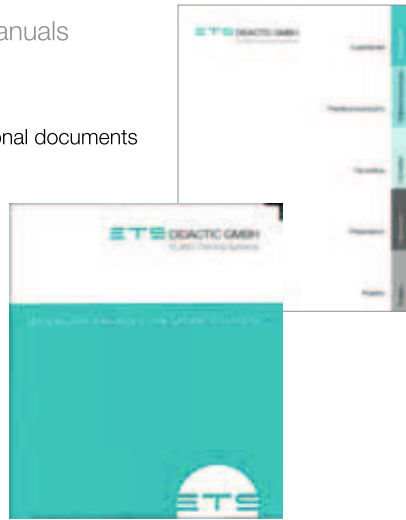

compact

- techNoCards®
- › depiction of the parameters in function groups
 - › start-up instructions
 - › safety functions
 - › individual learning help

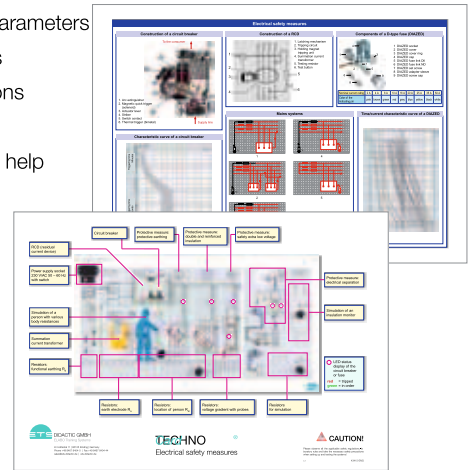

close to practice

- instructor's edition / student edition
- › 100 % function guarantee
 - › High print quality
 - › digital and on paper
 - › original photographs with practical references
 - › detailed work instructions



motivating

- simulations software
- › accompanying the courseware
 - › function simulation
 - › combination of theory and practice



multimedia

- front panel overlays
- › contents reduced to main focus of the experiment
 - › clear layout
 - › Basic function
 - › various languages



efficient

- furniture
- › technically matched conception
 - › excellent functionality
 - › ergonomics at the workplace
 - › outstanding design



ergonomics

... the system for Protective Measures

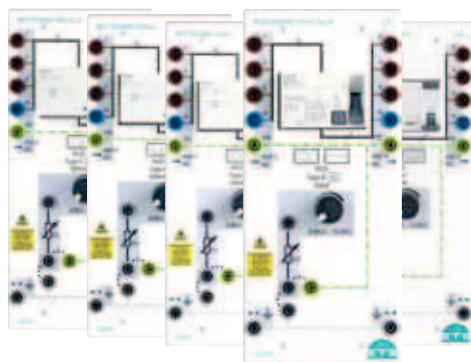
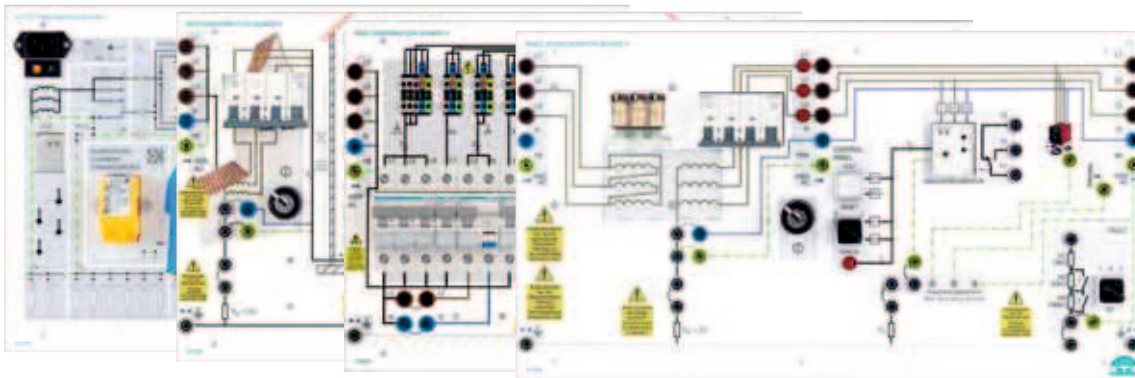

- › state-of-the-art technology
- › easy to operate
- › didactically prepared courseware
- › safety for people and machine
- › Perfect ergonomic workplaces

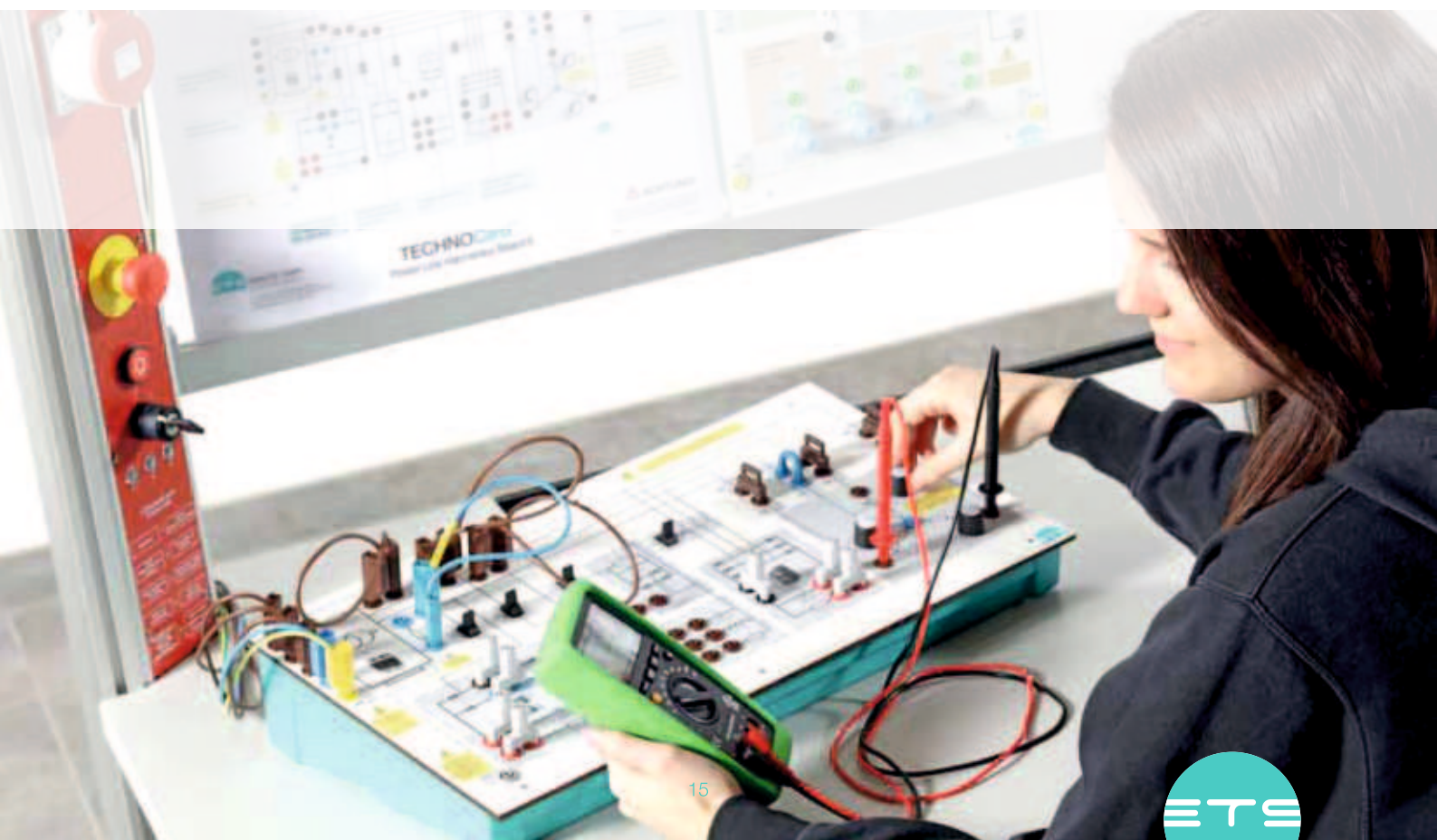



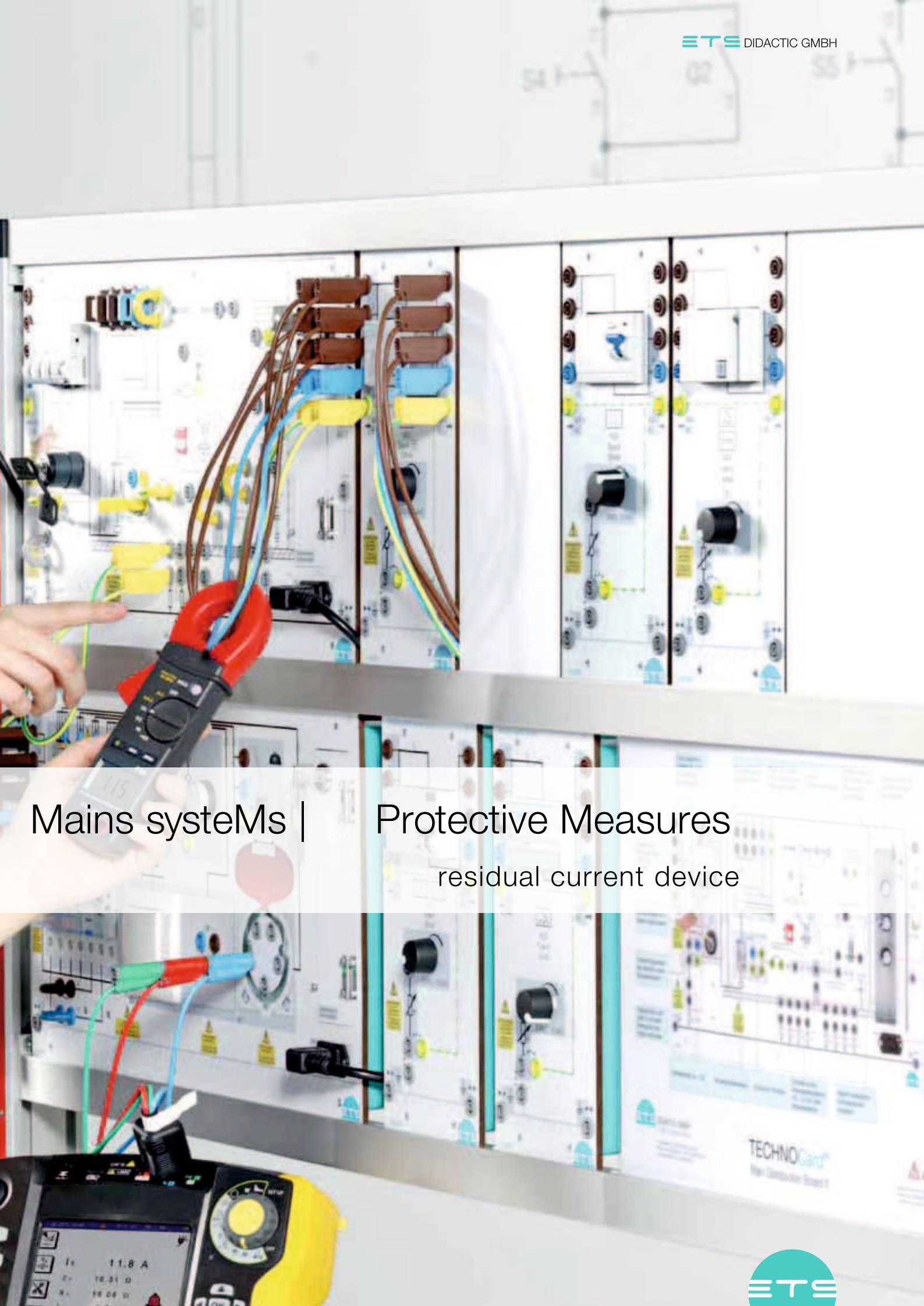

Mains systems | Protective Measures
residual current device



electrical Protective Measures

all at a glance

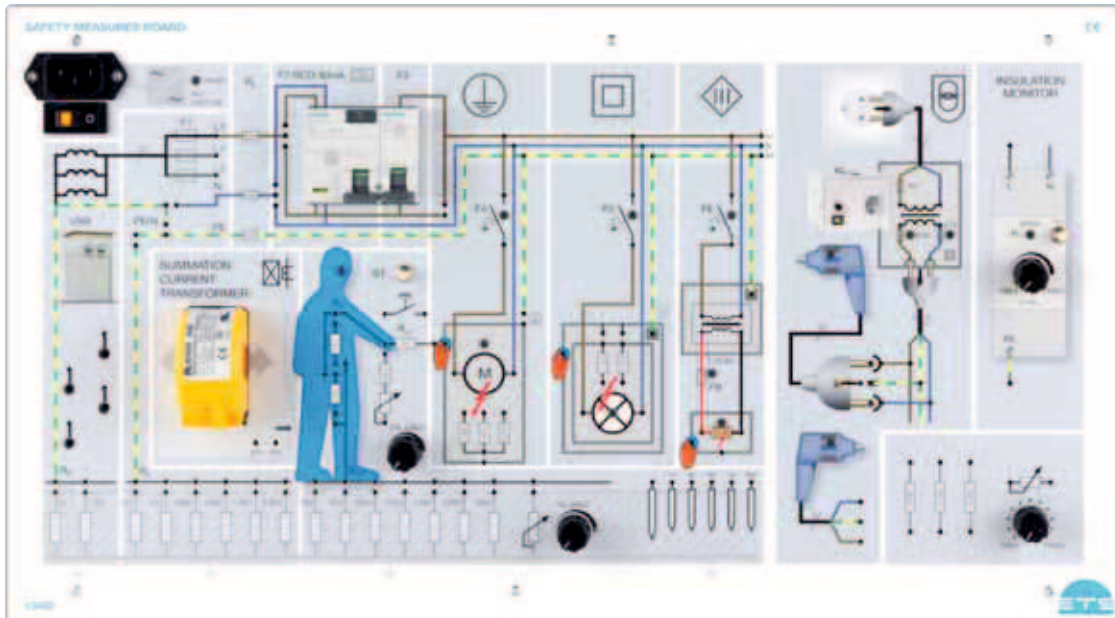

1

the safety Measures Board is designed for experiments related to the subject of electrical measures. safety extra-low voltage ensures optimum safety for the user.

the use of the devie is possible without any problems in any room due to the use of a protective contact plug. the tn-c, tn-c-s, tn-s, tt and it systems can be represented.

you can perform the experiments with the listed learning objectives and topics using this training system.

Learning objectives

-) structure of electrical systems
-) Hazards due to overload, short circuit and overvoltage, as well as calculation of the required protection elements
-) Examination of different protective measures in tn-c, tn-c-s, tn-s, tt and it systems
-) Protective measures according to din vde 0100
-) Effect of current on the organism, safety rules, emergency measures in case of accidents
-) Measures against dangerous body currents according to valid regulations
-) determination of the heart current factor

Performance features

-) simulation of an electrical system with transformer station, house connection, rcd circuit breaker, fuse and consumers
-) simulation of a foundation earth electrode with different earth resistances
-) simulation of main potential equalization
-) simulation of the house connection with formation of different mains systems by means of jumper plugs
-) Built-in power supply, single-phase socket is sufficient

No.	Designation	Order No.
1	safety Measures Board	43400
2	digital multimeter	90600

Advantages

- › safe experimentation through the use of extra low voltage 1:10
- › no special measuring equipment necessary
- › representation of the protection classes



experimental procedure with commercially available multimeters

(More information about the digital multimeter can be found on page 70).

2

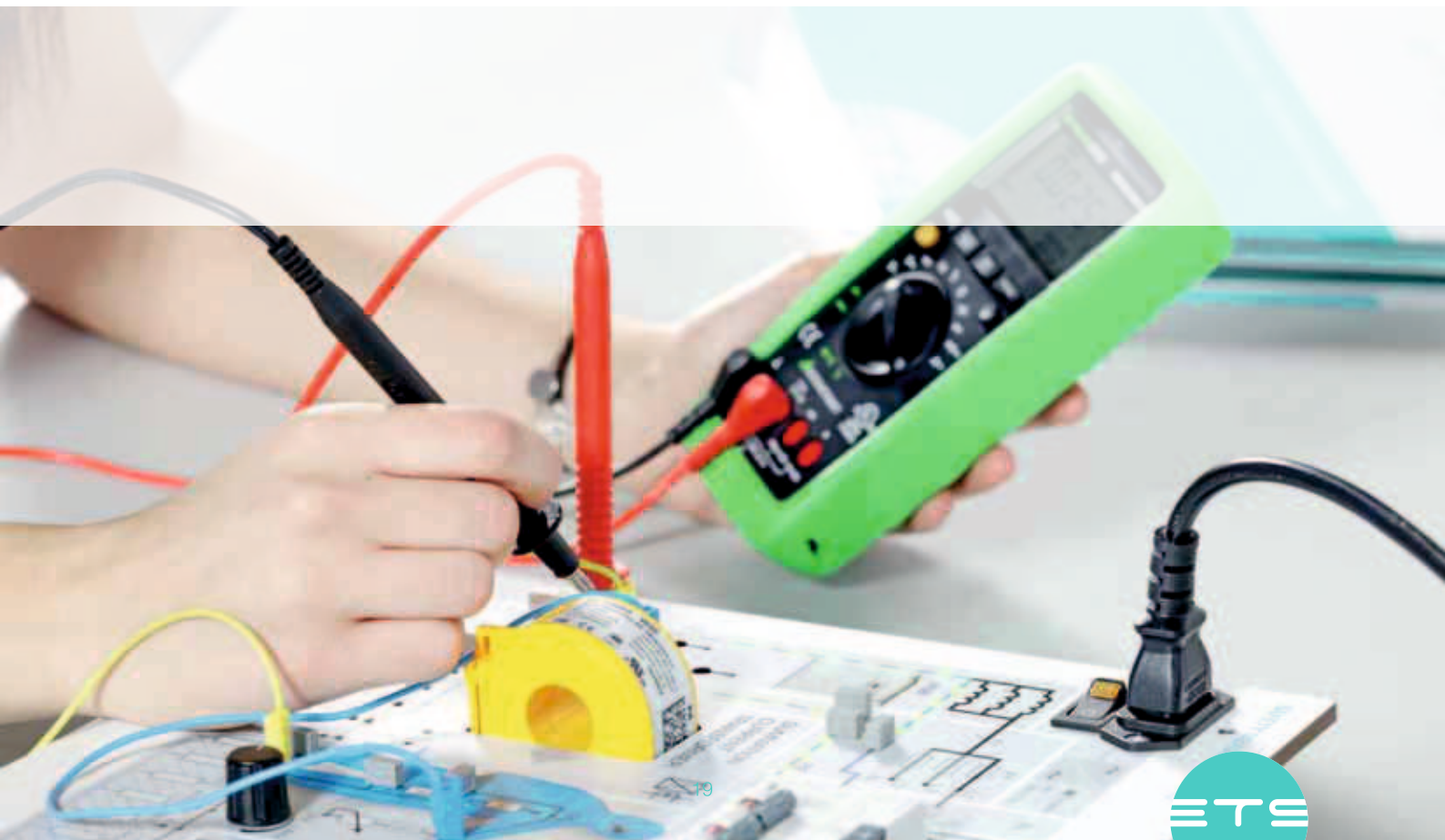
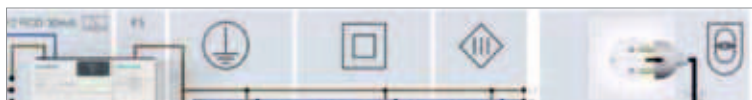

electrical Protective Measures

courseware



Printed and digital

1

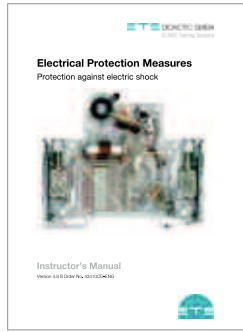

2

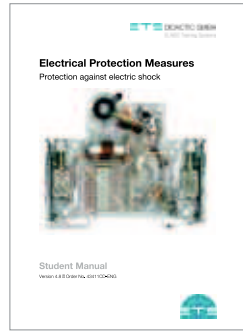

3

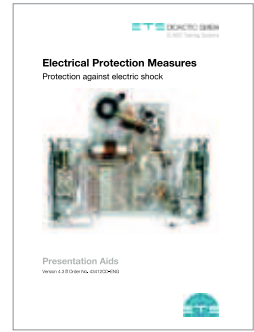

4

Manual content

- › fundamentals
- › network systems
- › Basic protection and fault protection
- › residual current device
- › Protective separation
- › it system
- › Protection by double or reinforced insulation
- › Protective extra-low voltage and functional extra-low voltage
- › s tep voltage



TECHNOCard®

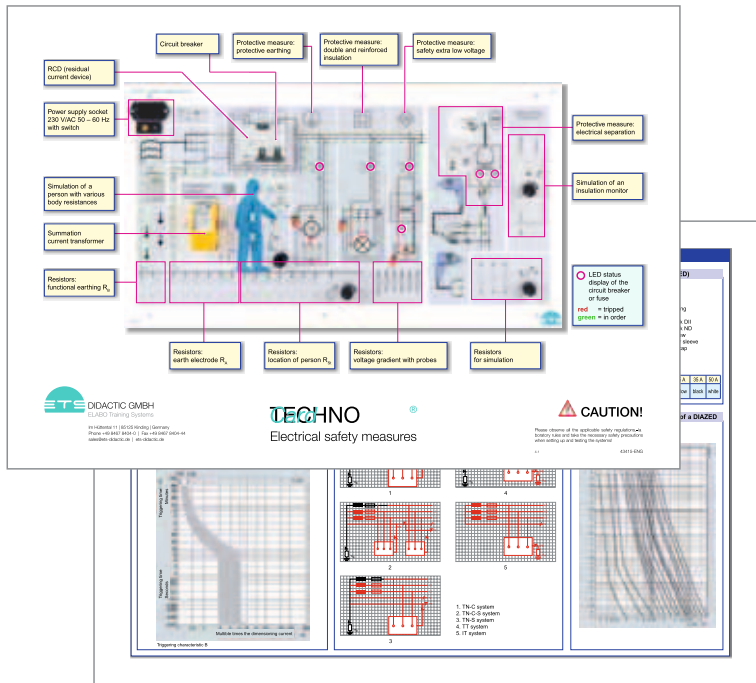

the techno cards® are a practical supplement to the training system. on them, the trainee finds a kind of knowledge store in concentrated, clear form for constant reference during practical work.

- › display board in 303mm x 426mm format
- › double-sided color design
- › robust, hard-wearing quality

5

No.	Designation	Order No.
1	set of ets ring binders	91903
2	electrical protective measures – instructor’s Manual	43410cd-eng
3	electrical protective measures – student Manual	43411cd-eng
4	electrical protective measures – Presentation aids	43412cd-eng
5	technocard® - electrical protective measures	43415-eng



Mains systems and Protective Measures

House connection of the customer plant

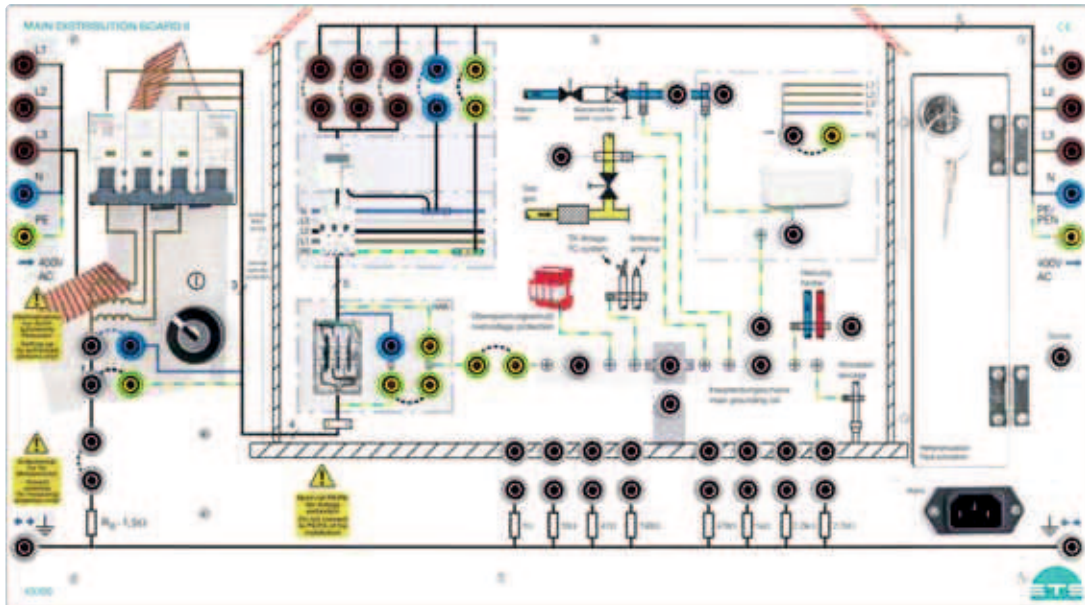

1

Learning objectives

- › structure of the public network/network system of the feeding network
- › network system of the consumer installation
- › selection of protective measures for a consumer installation
- › selecting and applying measuring and test equipment for measurements according to:
 - din vde 0100-410
 - din vde 0100-600
 - accident Prevention regulations dguv
- › interpreting measuring results
- › apply regulations for initial and repeat tests and create a schedule/flowchart of required measurements

- › carry out and describe the commissioning of low-voltage switchgear assemblies and create test report
- › carry out and describe initial and repeat tests of electrical systems and create test reports

Performance features

- › circuit breaker ($I_n = 6 \text{ a}$)
- › Key switch for enabling
- › easy change of the mains form via jumper plug
- › simulation of a foundation earth electrode with different earth resistances
- › simulation of the external lightning protection

- › Possibility to connect a probe for earth measurement
- › reproduction of main equipotential bonding
- › simulation of additional potential equalization in the bathroom
- › replication of the house connection with the formation of the different network systems using jumper plugs
- › replication of the counter space
- › connection panel for sub-distribution boards

- › simple fault simulation by rotary switches for:
 - loop and mains internal resistance measurement
 - low-resistance connection of protective and equipotential bonding conductors
 - insulation fault for insulation resistance measurement

No.	Designation	Order No.
1	Main distribution Board ii	43300

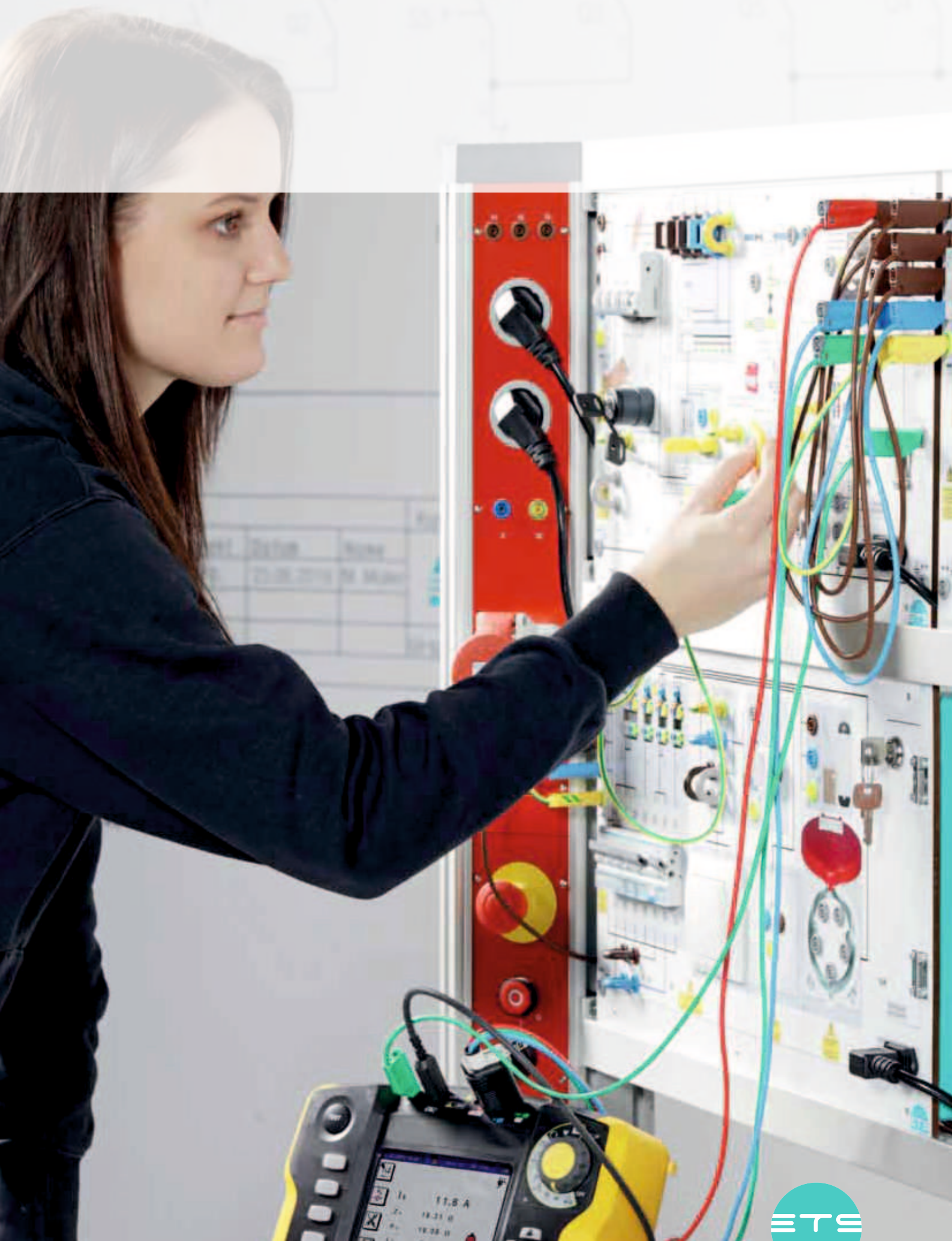

Main distriBution Board

House connection of the customer plant

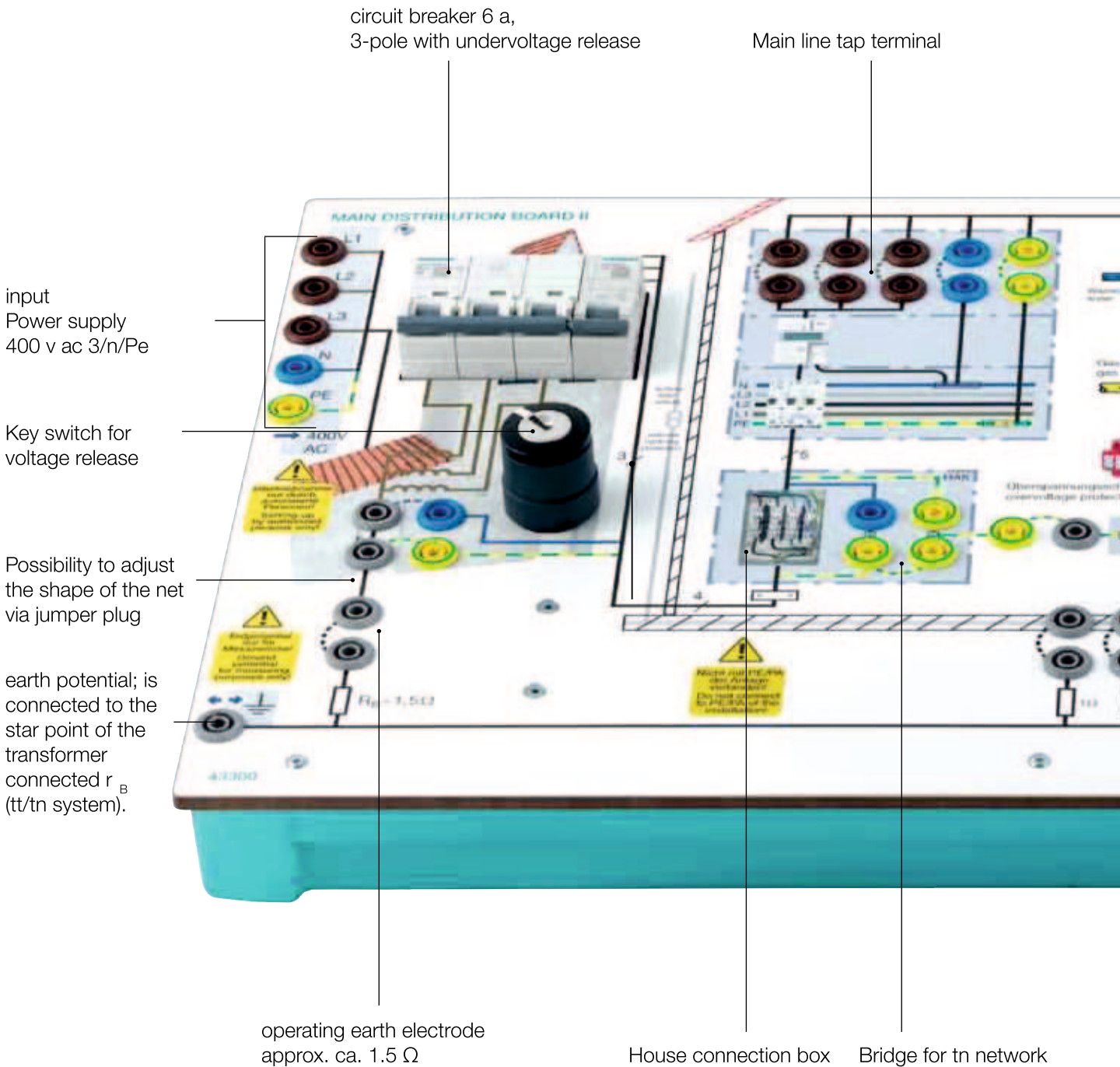

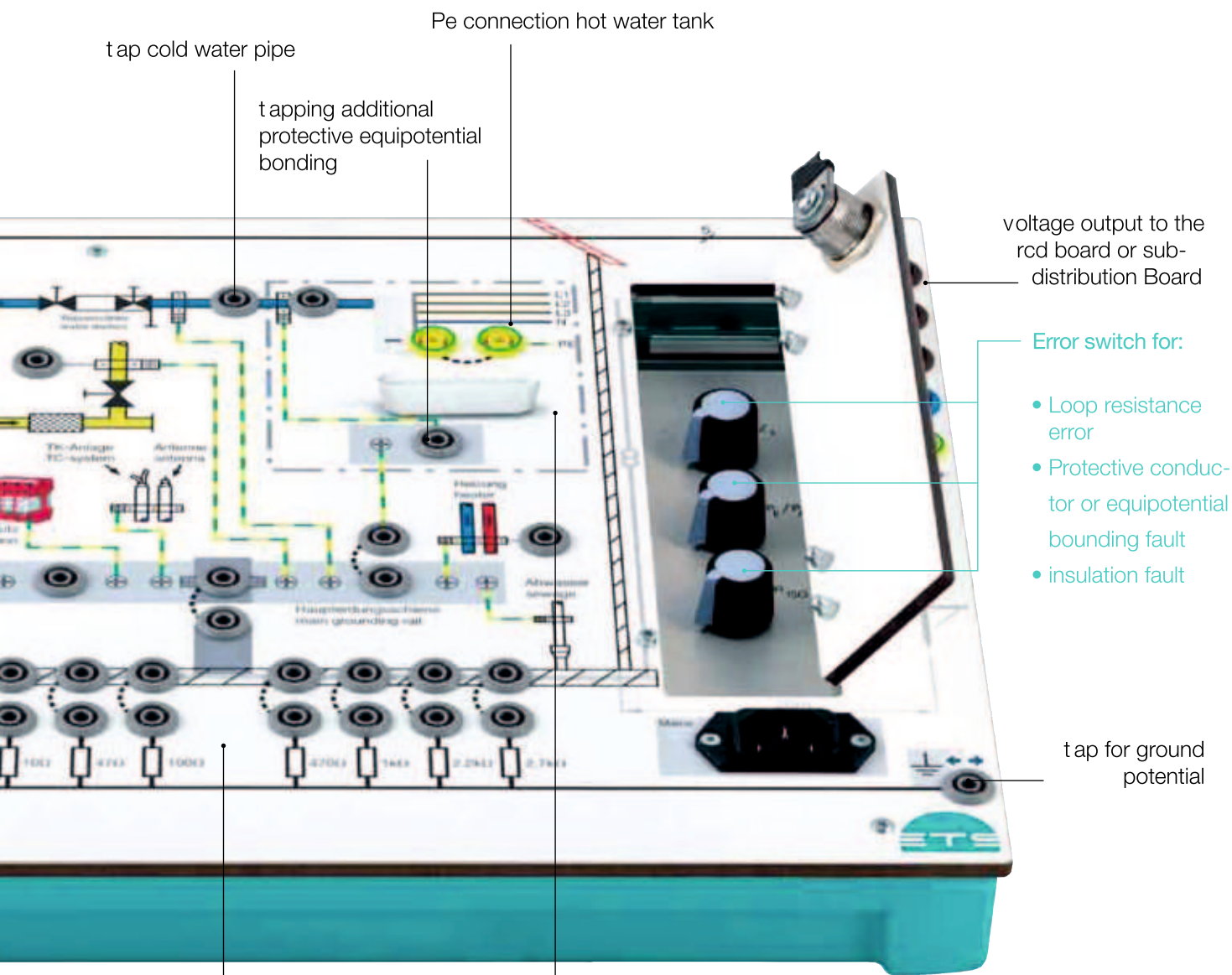

rcd circuit Breaker

rcd types

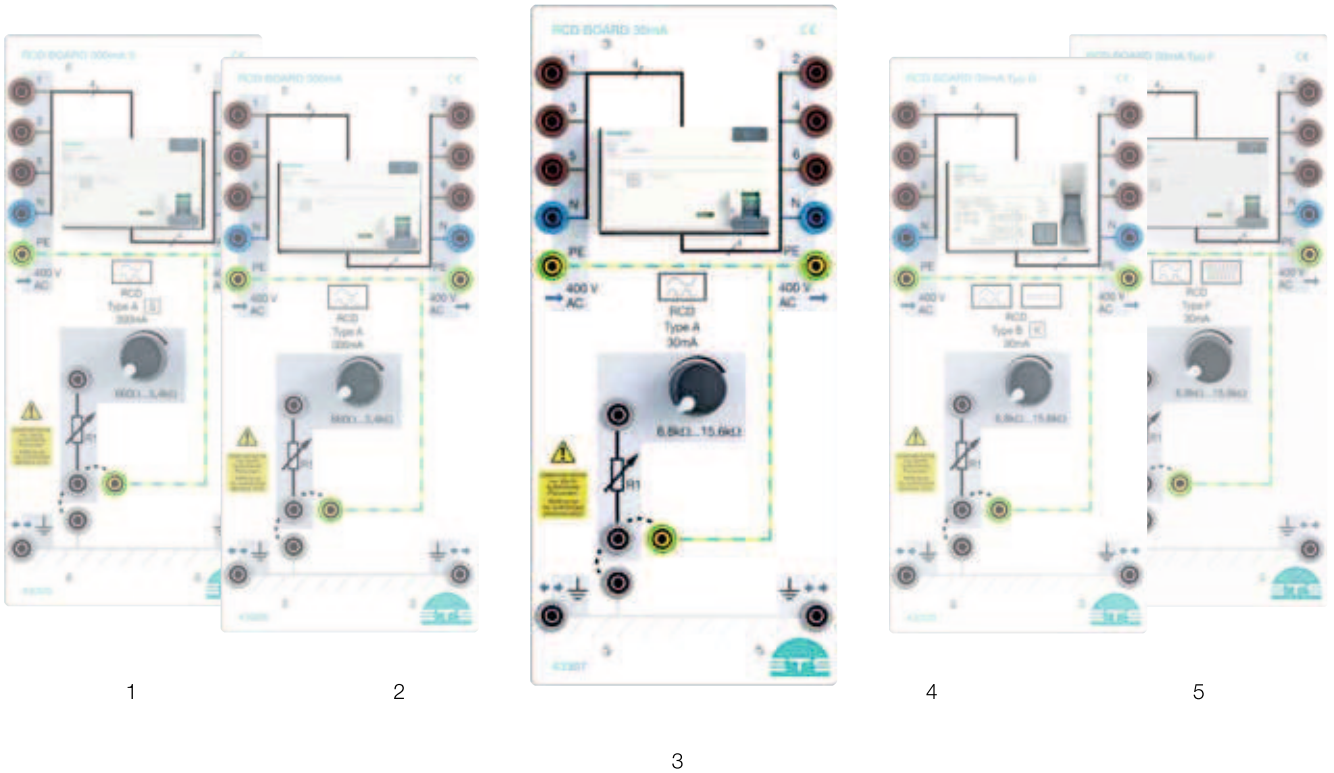

Learning objectives

- › selection of protective measures for a consumer installation
- › selecting and applying measuring and test equipment for measurements according to:
 - din vde 0100-410
 - din vde 0100-600
 - accident Prevention regulations dguv
- › interpreting measuring results
- › apply regulations for initial and repeat tests and create a schedule/flowchart of required measurements
- › carry out and describe the commissioning of low-voltage switchgear assemblies and create test report
- › carry out and describe initial and repeat tests of electrical systems and create test reports

Performance features (1)

- › residual current circuit breaker $i_{\Delta n}$ 300 ma/selctive
- › Potentiometer for simulation of residual currents

Performance features (2)

- › residual current circuit breaker $i_{\Delta n}$ 300 ma
- › Potentiometer for simulation of residual currents

Performance features (3)

- › residual current circuit breaker $i_{\Delta n}$ 30 ma
- › Potentiometer for simulation of residual currents

Performance features (4)

- › residual current circuit breaker $i_{\Delta n}$ 30 ma t ype B
- › Potentiometer for simulation of residual currents

Performance features (5)

- › residual current circuit breaker $i_{\Delta n}$ 30 ma t ype f
- › Potentiometer for simulation of residual currents

No.	Designation	Order No.
1	rcd Board 300ma s	43305
2	rcd Board 300ma	43306
3	rcd Board 30ma t ype a	43307
4	rcd Board 30ma t ype B	43308
5	rcd Board 30ma t ype f	43309



rcd circuit Breaker

rcd circuit Breaker – overview

rcd Board 300 ma s



rcd Board 300 ma

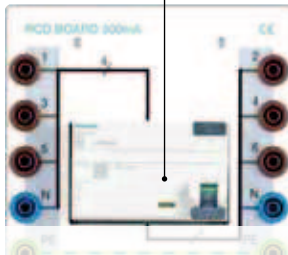

rcd Board 30 ma t type a

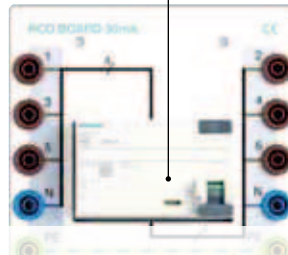

rcd Board 30 ma type B



rcd Board 30 ma t type f



Proper function of the residual current circuit breaker						
Current form	Type AC	Type A	Type F	Type B	Type B+	Tripping current
	•	•	•	•	•	0,5 – 1,0 I _{res}
	•	•	•	•	•	0,35 – 1,4 I _{res}
	•	•	•	•	•	Beed angle 135° 0,11 – 1,4 I _{res}
	•	•	•	•	•	max. 1,4 I _{res} + 6 mA (Typ A) + 10 mA (Typ F) + 0,4 I _{res} (Typ B+)
	•	•	•	•	•	0,5 – 1,4 I _{res}
	•	•	•	•	•	0,5 – 2,0 I _{res}

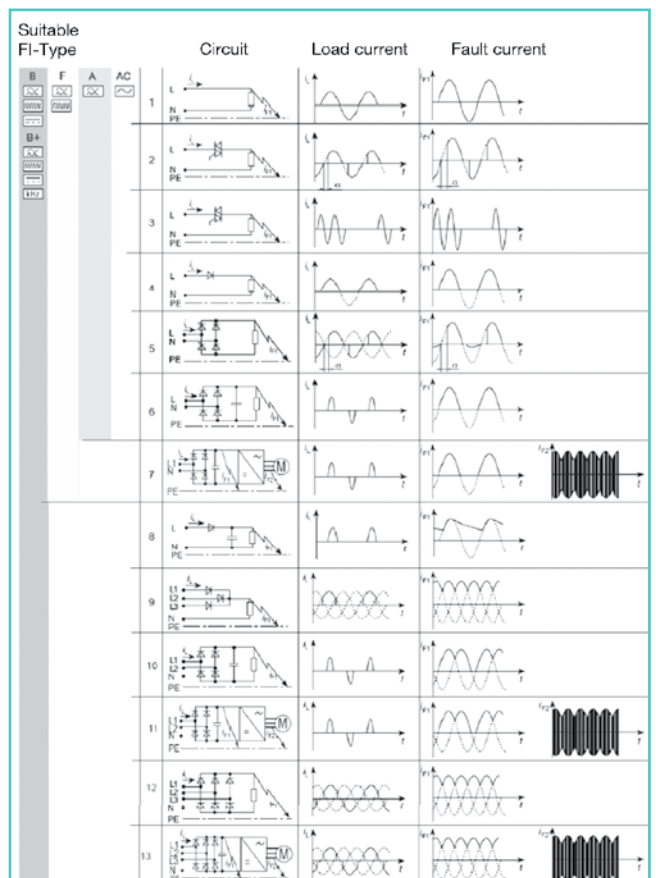

rcd circuit Breaker – in detail

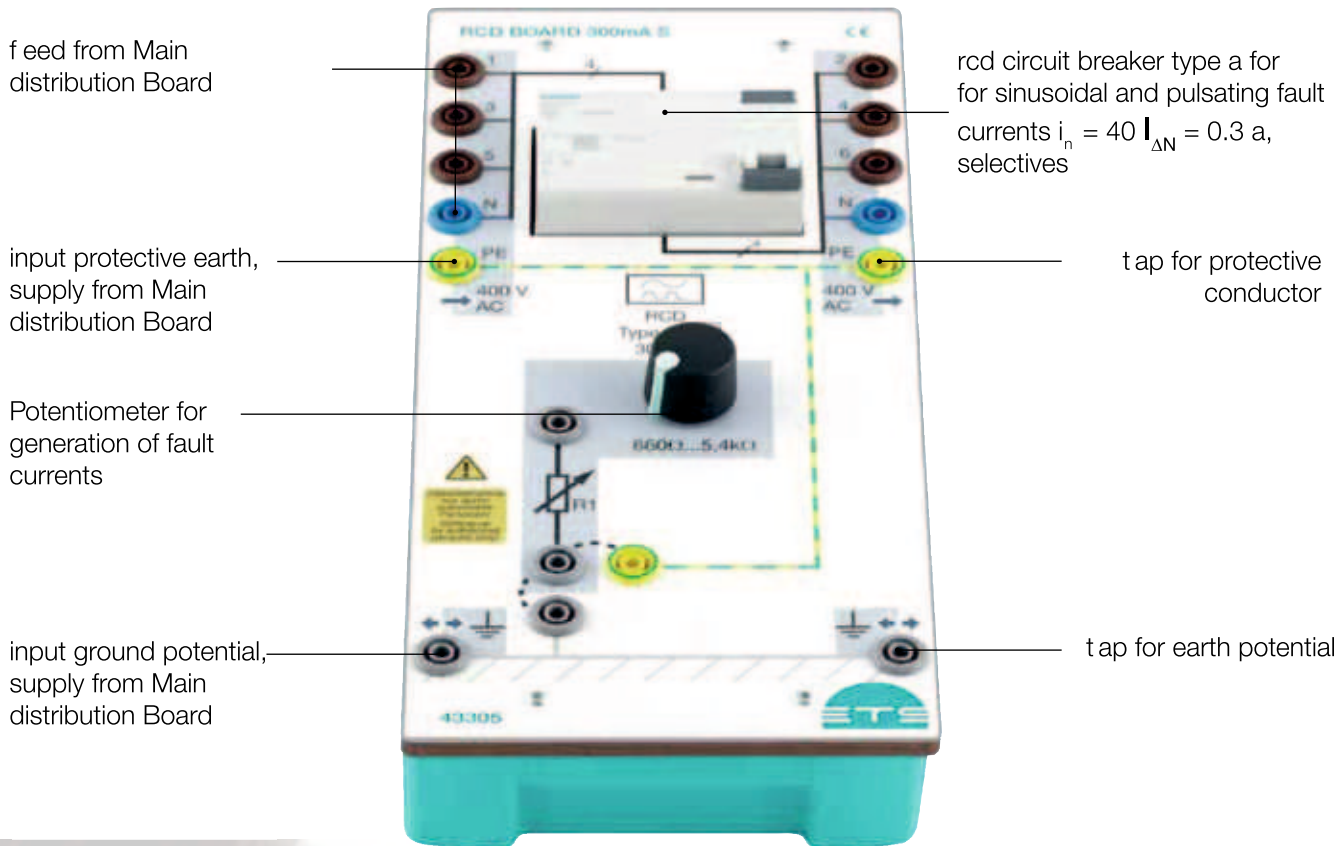

customer Plant

sub-distribution of the customer plant

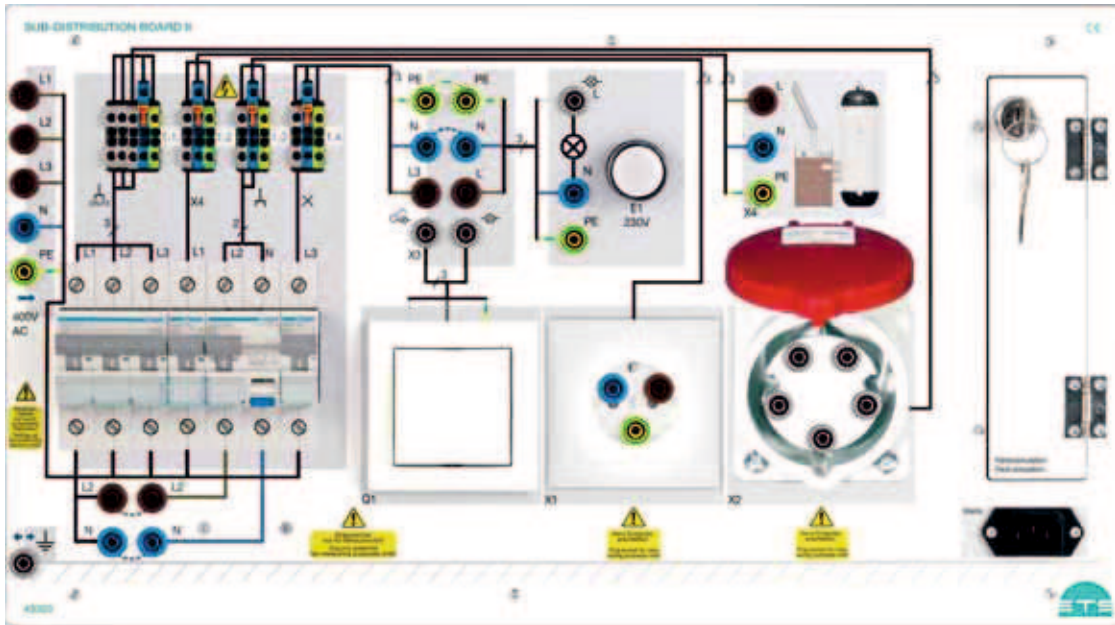

1

Learning objectives

- } selection of protective measures for a consumer installation
- } selecting and applying measuring and test equipment for measurements according to:
 - din vde 0100-410
 - din vde 0100-600
 - accident Prevention regulations dguv
- } interpreting measuring results
- } apply regulations for initial and repeat tests and create a schedule/flowchart of required measurements
- } carry out and describe the commissioning of low-voltage switchgear assemblies and create test report
- } carry out and describe initial and repeat tests of electrical systems and create test reports

Performance features

- } sub-distribution board with:
 - circuit breaker: c13 a; 3-pole
 - circuit breaker: B13 a; 1-pole
 - fi/ls circuit breaker (rcBo): B16 a/30 ma
 - circuit breaker: B10 a; 1-pole
 - Measuring points led out via commercially available terminal blocks
- } consumers:
 - three-phase consumer: indication of a cee sockets 5-pin with si sockets
 - } alternating current consumer:
 - luminaire switched via a switch junction box
 - schuko socket imitation 3-pin with si sockets
 - Heating connection indication of heating connection 3-pin with si sockets

No.	Designation	Order No.
1	sub-distribution Board ii	43303



customer Plant

sub-distribution of the customer plant

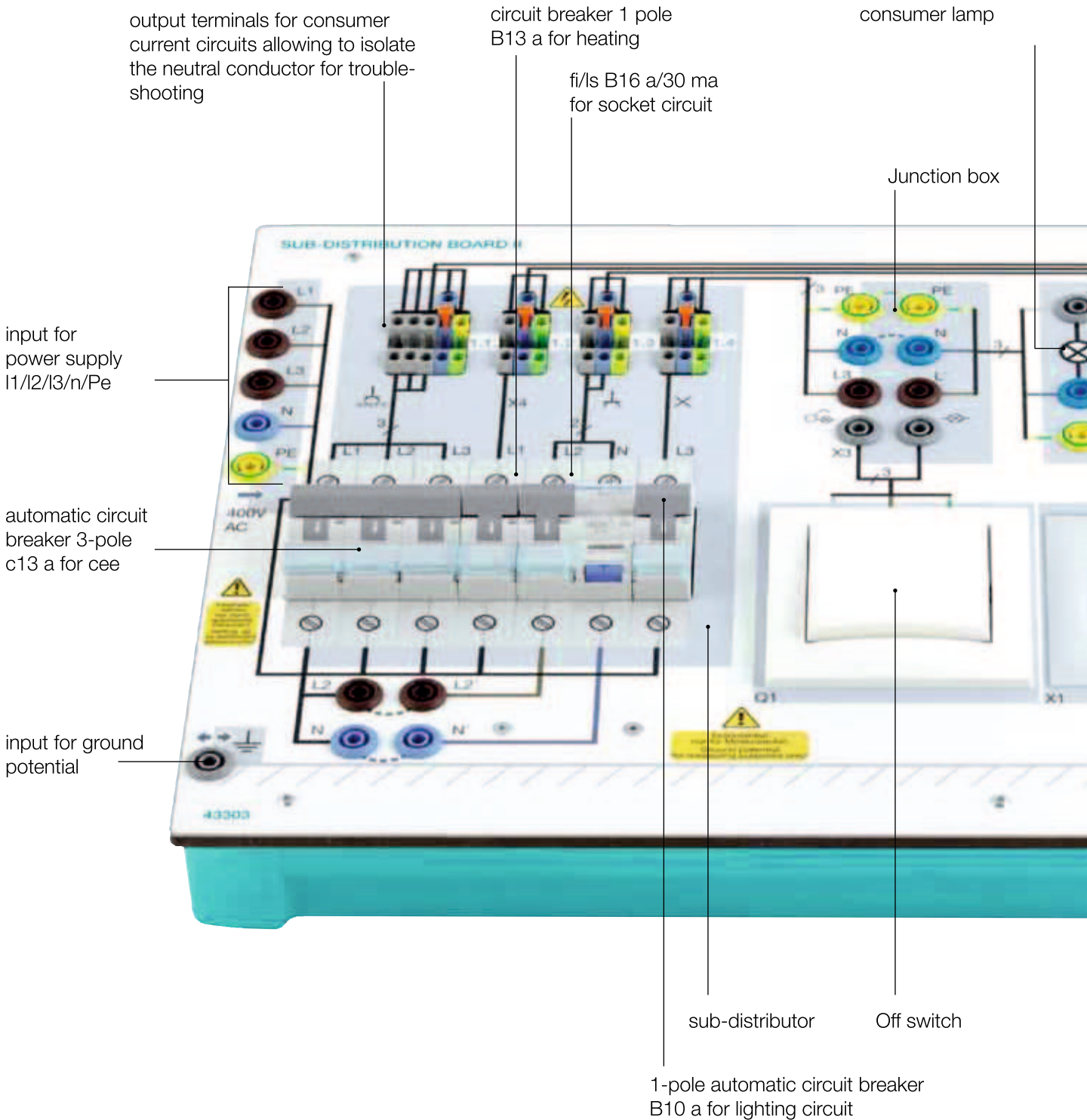

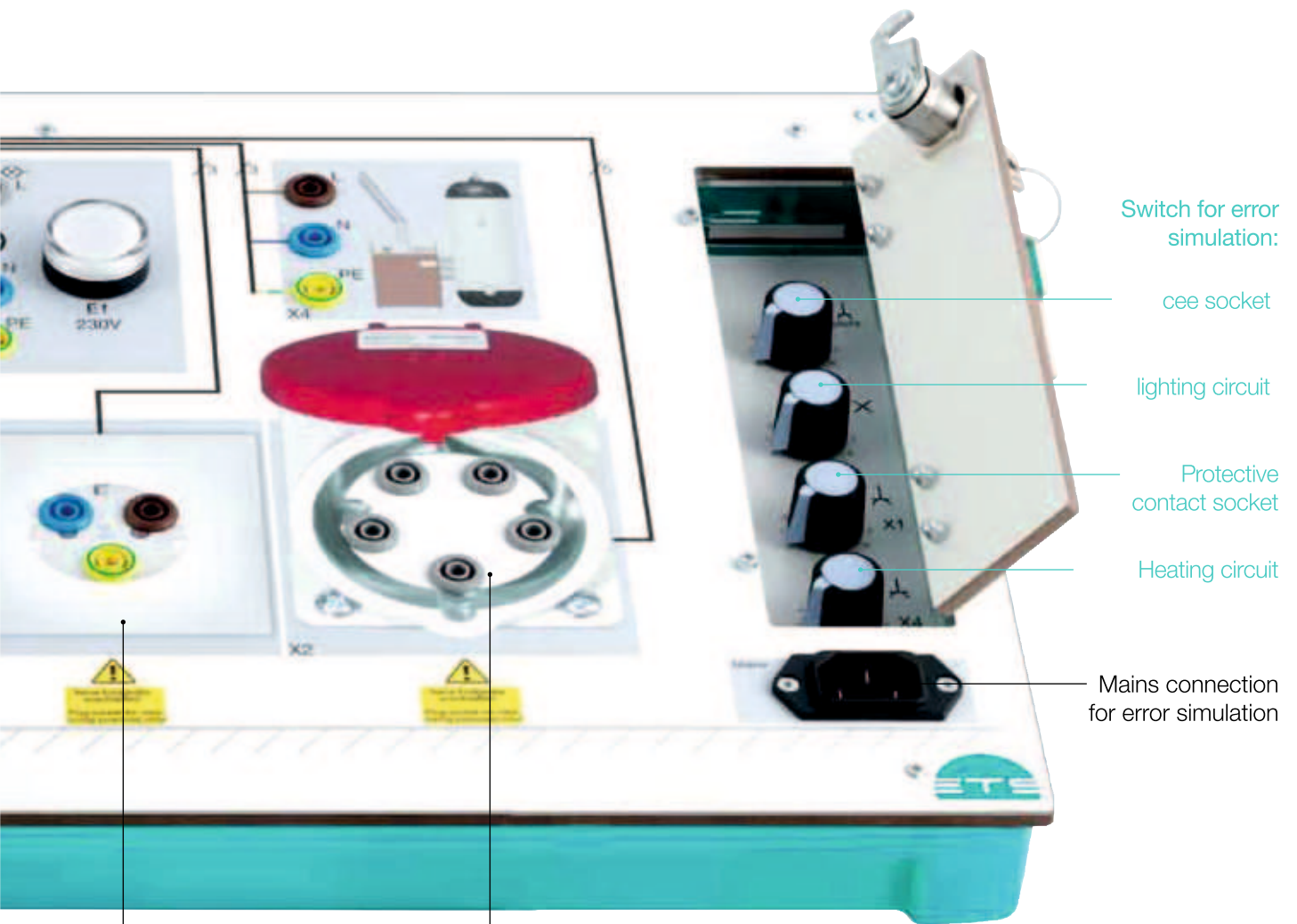

Switch for error simulation:

cee socket

lighting circuit

Protective contact socket

Heating circuit

Mains connection for error simulation

Protective contact sockets

cee socket

training Package tP 26.1.2

Main system and Protective Measures

Learning objectives

- > structure of the public supply main/incoming main system
- > customer installation of the main system
- > selection of protective measures according to the requirements of the customer's system
- > selecting and applying measuring instruments according to
 - din vde 0100-410
 - din vde 0100-600
 - din vde 0105-100
 - dguv regulation 3
- interpreting measurement results
- > applying the provision for the initial and repeated tests and drawing up a flow chart of the required measurements
- > carrying out and describing initial and repeated tests of electrical installations and writing test protocols

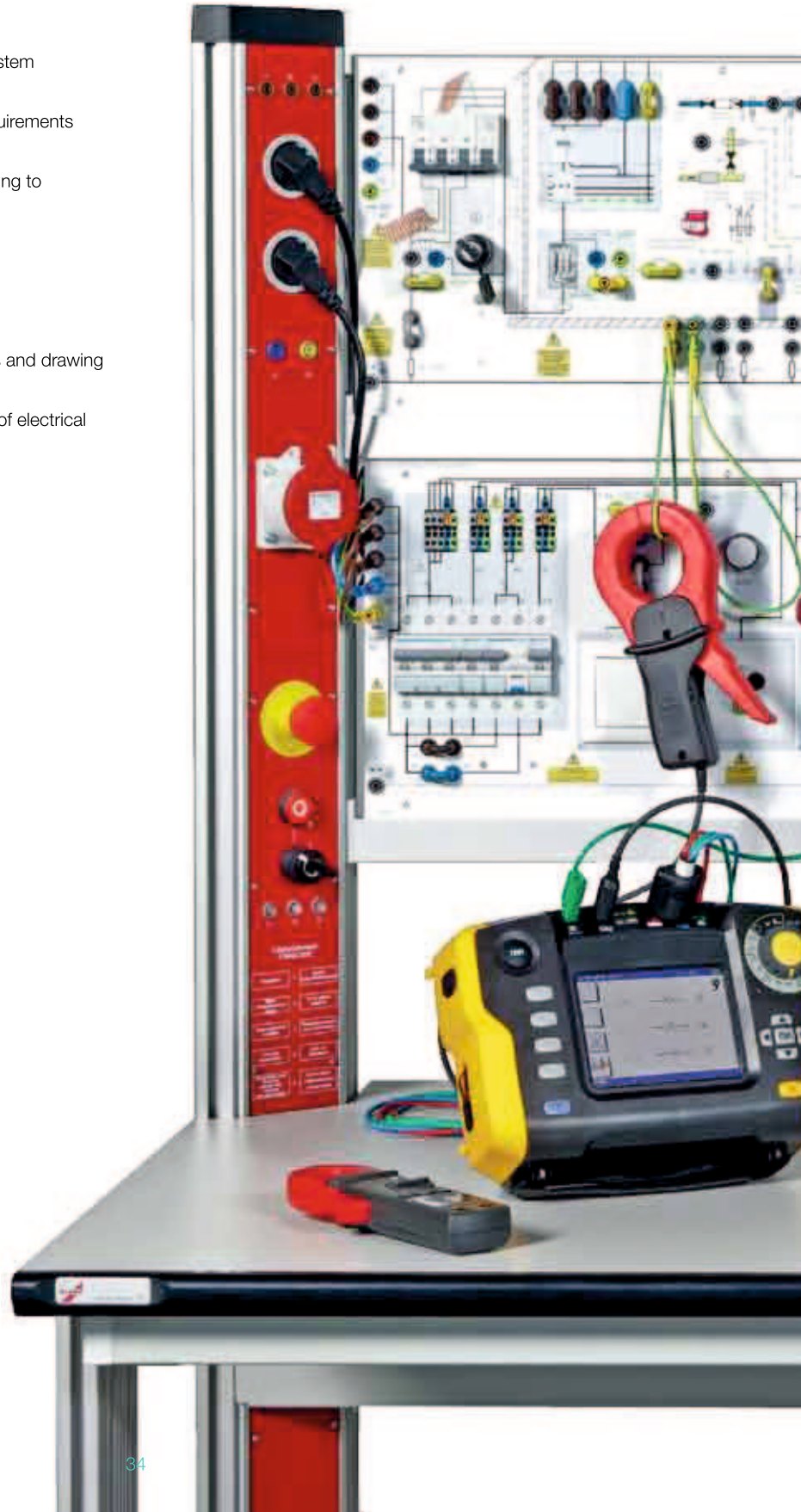

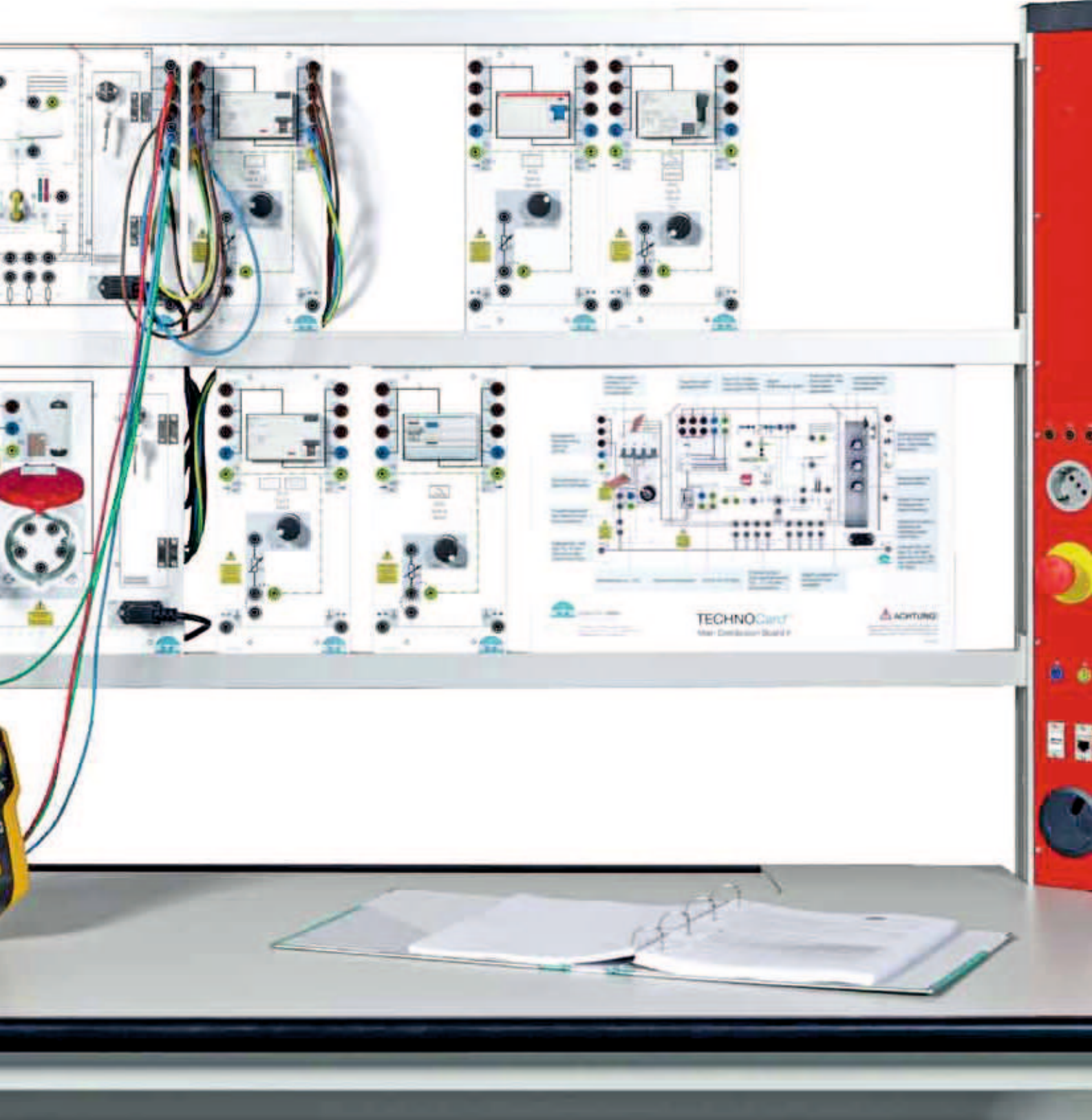

Mains systems and Protective Measures

it system: insulation Monitoring

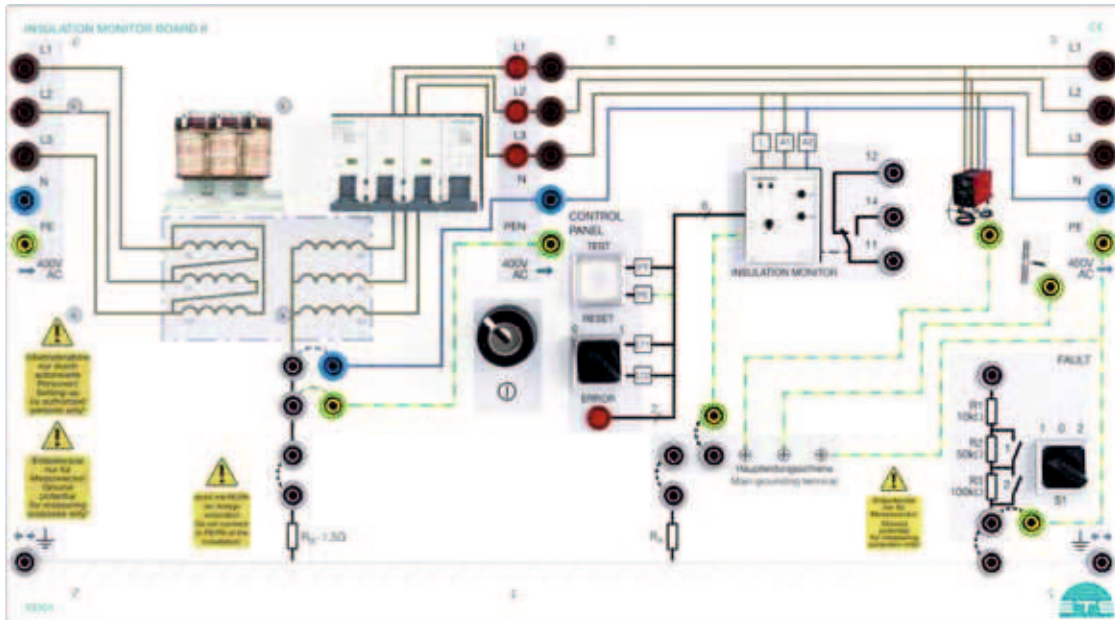

1

Learning objectives

- › selection of protective measures for a consumer installation
- › selecting and applying measuring and test equipment for measurements according to:
 - din vde 0100-410
 - din vde 0100-600
 - accident Prevention regulations dguv
- › interpreting measuring results
- › apply regulations for initial and repeat tests and create a schedule/flowchart of required measurements
- › carry out and describe the commissioning of low-voltage switchgear assemblies and create test report
- › carry out and describe initial and repeat tests of electrical systems and create test reports

Consisting of

- › three-phase transformer (400/400 v/200 va)
- › line circuit breakers ($i_n : 1a$)
- › Key-operated switch
- › Phase control lamps: I1, I2, I3
- › easy change of main form via jumper plug
- › insulation monitoring device for insulation monitoring of unearthed ac systems (it system) with one or three phases
 - supply voltage: ac 115/230 v
 - Measuring voltage: up to ac 500 v
 - Measuring range: 10 - 110 kΩ
- › Button for resetting the stored alarm
- › Button for fault simulation (external test button)
- › indicator light as an alarm signal generator
- › indication of the building potential equalization
- › switchable measuring resistors for generation of insulation fault/earth fault

No.	Designation	Order No.
1	insulation Monitor Board ii	43304

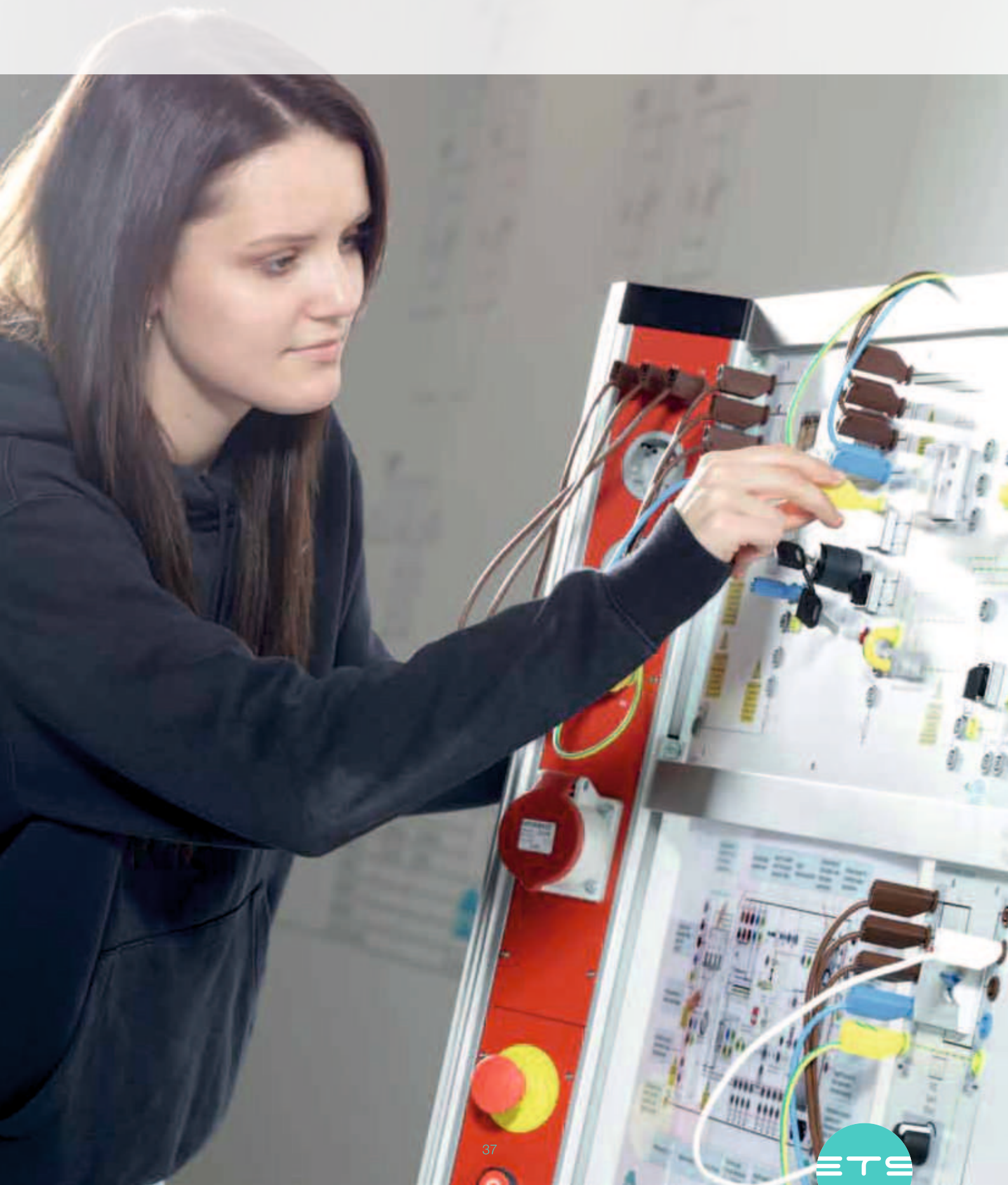

Main systems and Protective Measures

courseware



Printed and digital

1

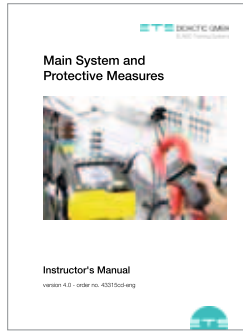

2

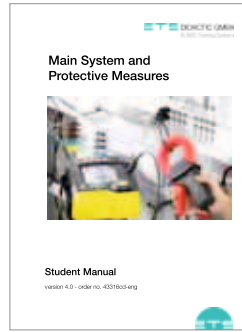

3

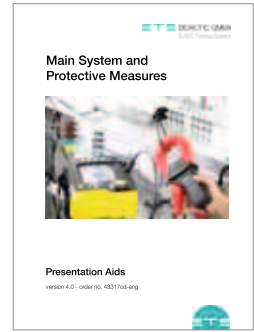

4

Manual content

- › Basics of network systems and their protective measures
- › electrical power supply and safety of equipment
- › testing of electrical equipment
- › initial test in tt systems
- › it system

No.	Designation	Order No.
1	set of ets ring binders	91903
2	Main systems & Protective Measures – instructor's Manual	43315cd-eng
3	Main systems & Protective Measures – student Manual	43316cd-eng
4	Main systems & Protective Measures – Presentation aids	43317cd-eng

TECHNOCard®

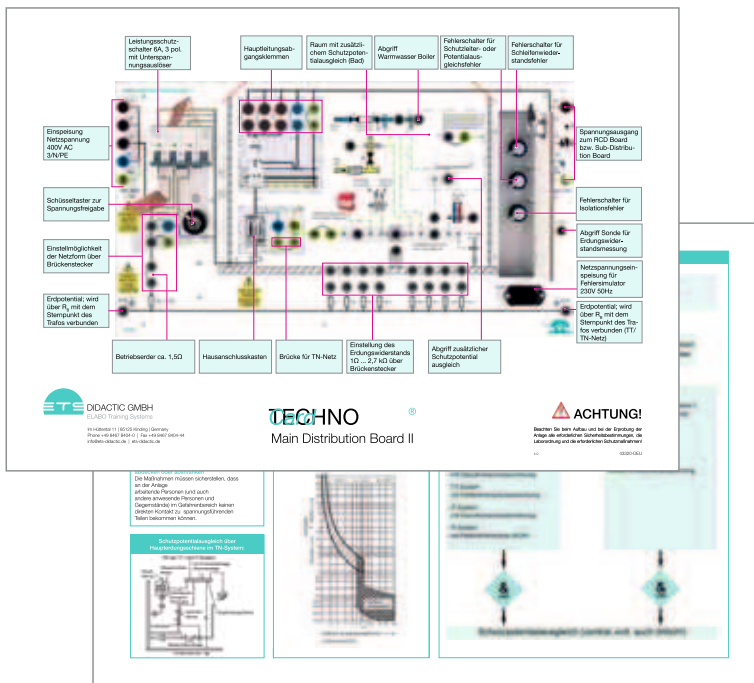

the techNoc ards® are a practical supplement to the training system. on them, the trainee finds a kind of knowledge store in concentrated, clear form for constant reference during practical work.

- › display board in 303mm x 426mm format
- › double-sided color design
- › robust, hard-wearing quality

5

No.	Designation	Order No.
5	techNoc ards® - Main distribution Board ii	43320-eng
n.ill.	techNoc ards® - sub distribution Board ii	43321-eng
n.ill.	techNoc ards® - insulation Monitor Board ii	43322-eng
n.ill.	techNoc ards® - rcd Board t ype a s 300 ma	43323-eng
n.ill.	techNoc ards® - rcd Board t ype a 300 ma	43324-eng
n.ill.	techNoc ards® - rcd Board t ype a 30 ma	43325-eng
n.ill.	techNoc ards® - rcd Board t ype B 30 ma	43326-eng
n.ill.	techNoc ards® - rcd Board t ype f 30 ma	43327-eng

vde 0100 / electric Main connection

Bst® Building systems rainer

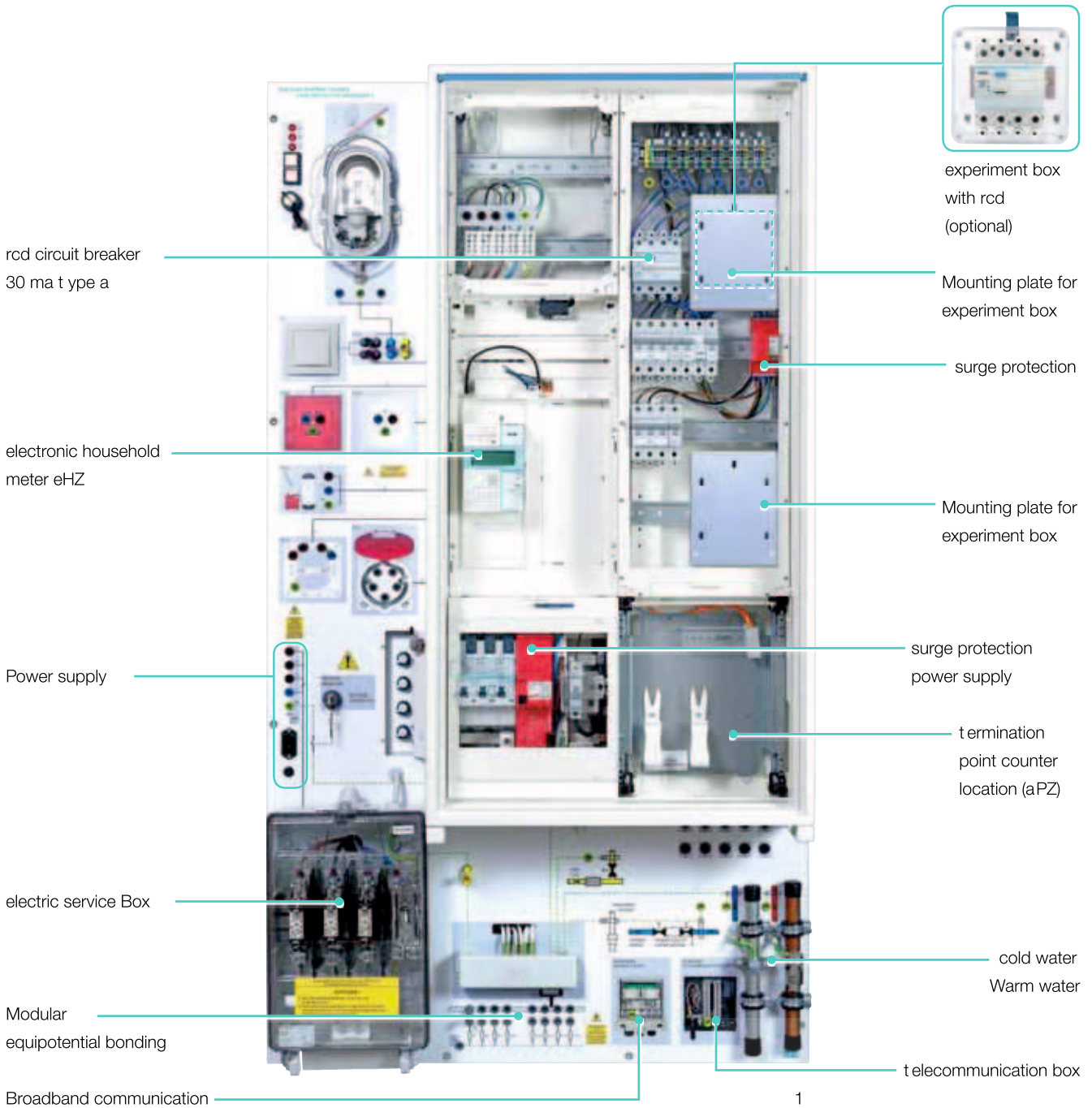

No.	Designation	Order No.
1	Bst® Protective Measures (mobile trolley optional)	43506
2	Bst® installation technologies (mobile trolley optional)	43504
3	Experiment boxes for different RCDs	on request

Learning objectives

- › structure of the public grid/grid system of the feeding grid
- › Mains of the consumer installation
- › selection of protective measures for a consumer installation
- › selecting and using measuring and test equipment for measurement according to din vde 0100-600 and interpreting measurement results
- › carry out and describe initial and repeat tests of electrical systems and create test reports
- › design of a meter system according to vde ar-n 4100



The flexible training system for building systems engineering with real components from ETS DIDACTIC.

The system is characterized by the holistic approach to knowledge transfer. It is mobile and the workplace can be fitted individually from two sides. the trainee can work and make measurements under real conditions and at the highest possible safety. apart from troubleshooting, the training concept comprises flush-mounted installation, replacement of NH-fuses and much more.



energy supply systems

courseware



Printed and digital

1

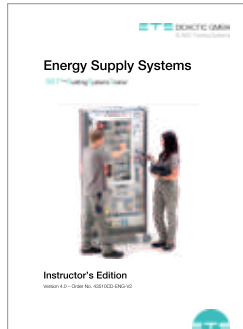

2

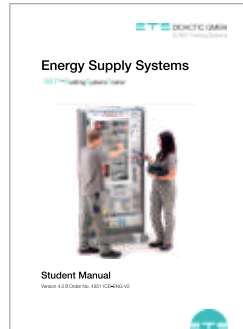

3

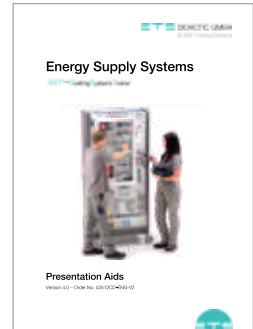

4

Manual content

- › Basics of network systems and their protective measures
- › electric power supply and safety of equipment
- › tn system
- › tn system (recurring test)
- › tt system



TECHNOCard®

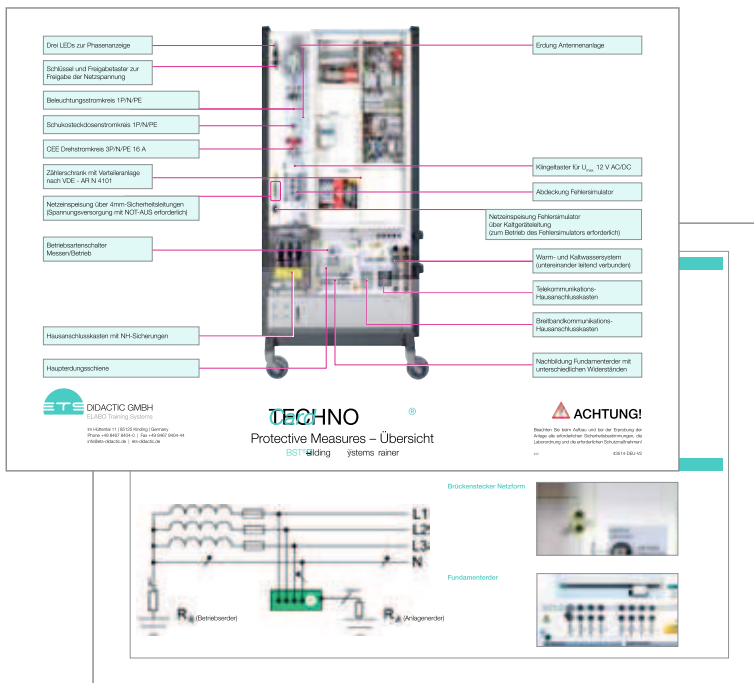

the techNoc ards® are a practical supplement to the training system. on them, the trainee finds a kind of knowledge store in concentrated, clear form for constant reference during practical work.

- › display board in 303mm x 426mm format
- › double-sided color design
- › robust, hard-wearing quality

5

No.	Designation	Order No.
1	set of ets ring bindres	91903
2	energy supply systems Bst ® – instructor’s Manual	43510cd-eng
3	energy supply systems Bst ® – student Manual	43511cd-eng
4	energy supply systems Bst ® – Presentation aids	43512cd-eng
5	techNoc ards® - overview	43514-eng
n.ill.	set of techNoc ards® - Building system trainer	43513-eng
n.ill.	techNoc ards® - Meter cabinet	43515-eng
n.ill.	techNoc ards® - fault loop impedance	43516-eng
n.ill.	techNoc ards® - Protective equipotential bonding via main earthing rail	43517-eng
n.ill.	techNoc ards® - Measurements for testing	43518-eng
n.ill.	techNoc ards® - test report according to din	43519-eng



loads on the neutral conductor
symmetrical | unsymmetrical load

loads on the neutral conductor

symmetrical and unsymmetrical loads

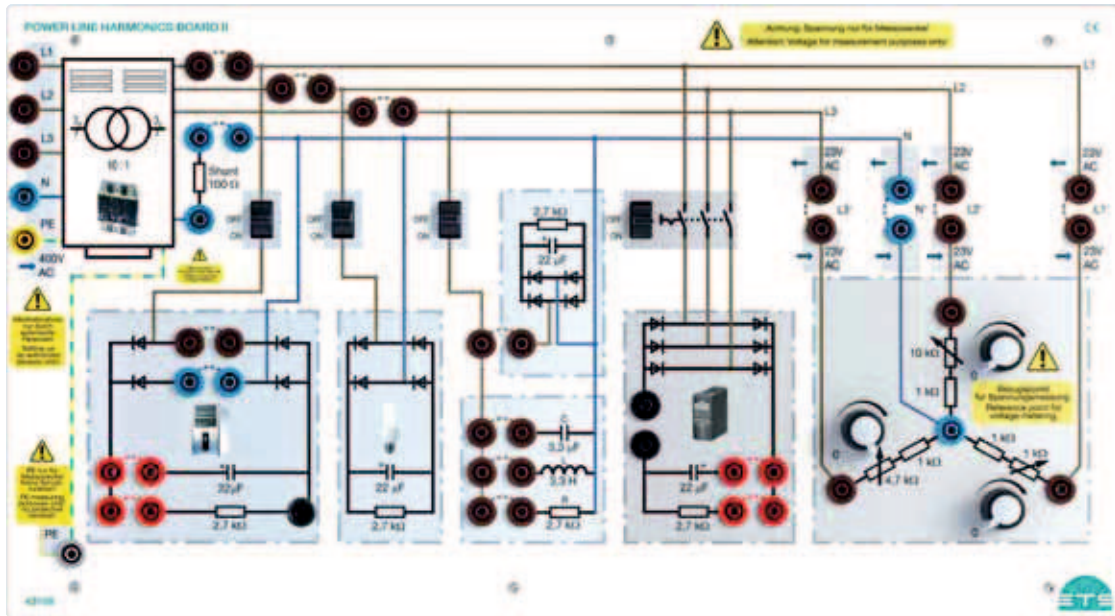

1

Learning objectives

- › understand the concatenation of voltages and currents of three-phase current systems through measurements, calculations, and plotting of line diagrams
- › determining currents, voltage and power in star circuits for symmetrical and unsymmetrical loads
- › Investigate effects of faults, e.g. failure of neutral conductor, outer conductor or load resistance
- › recognize the function of the neutral conductor in star connection and determine the cross-section
- › demonstrate the generation of harmonics by non-linear loads, such as PCs, motor control units or energy-savings lamps, using measurement techniques
- › recognize and measure overload of the neutral conductor by 3rd harmonic
- › examine the design and function of the M1, B2, B6u and M3u rectifier circuits
- › Measurement of voltages and currents at the rectifier circuits
- › isolating transformer 10:1
- › test circuit of a three-phase consumer in star connection

Technical data

- › isolating transformer 10:1
- › 3-phase
- › 3 linear loads in star connection
- › r, l and c load
- › 3 electronic consumers with rectifier
- › three-phase loads with B6u or M3U rectifier
- › Measuring shunt in the neutral conductor

No.	Designation	Order No.
1	Power line Harmonics Board ii	43108



PoWer line HarMOnics Board ii

symmetrical and unsymmetrical loads

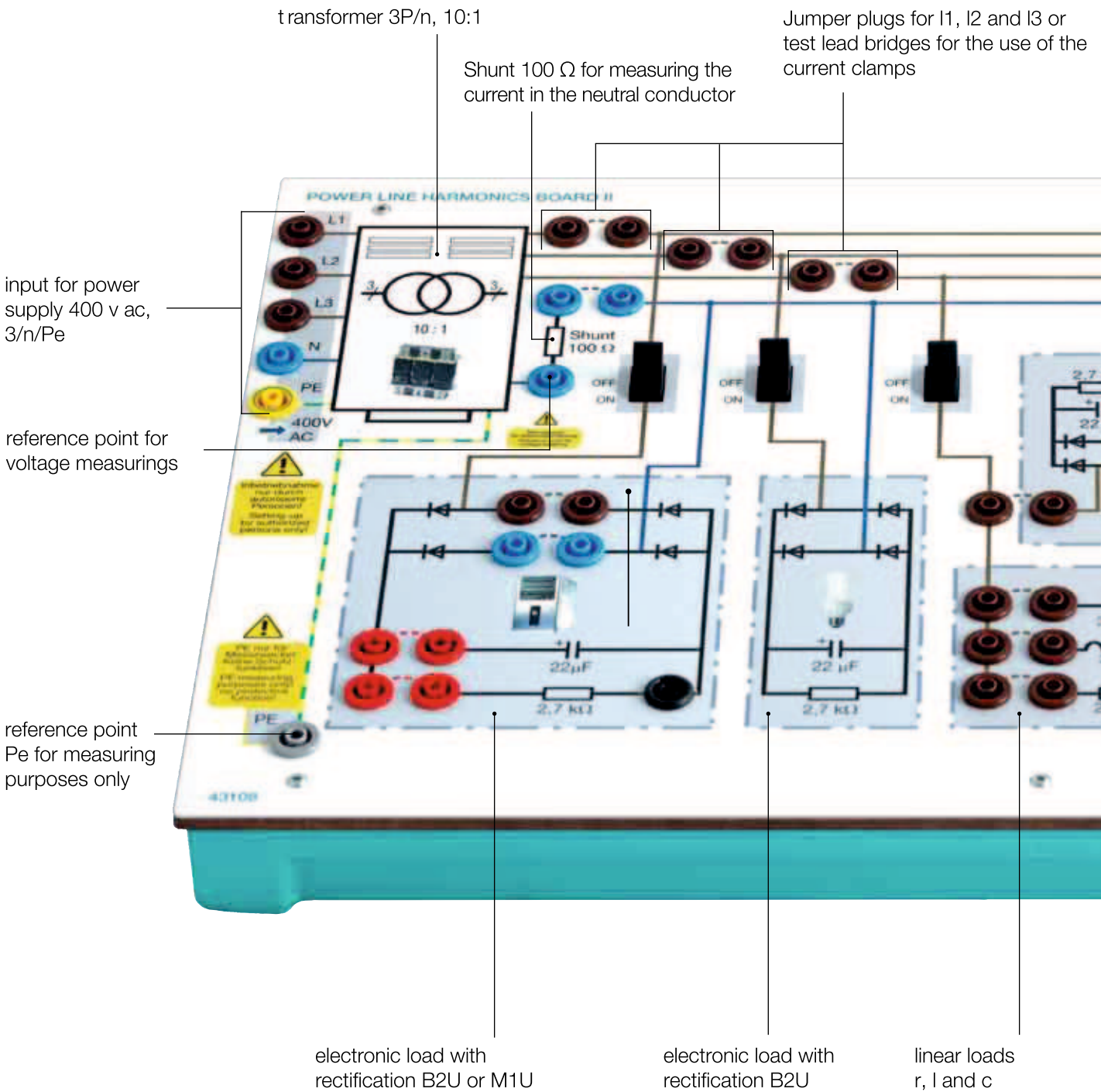

electronic load with bridge rectifier B2U

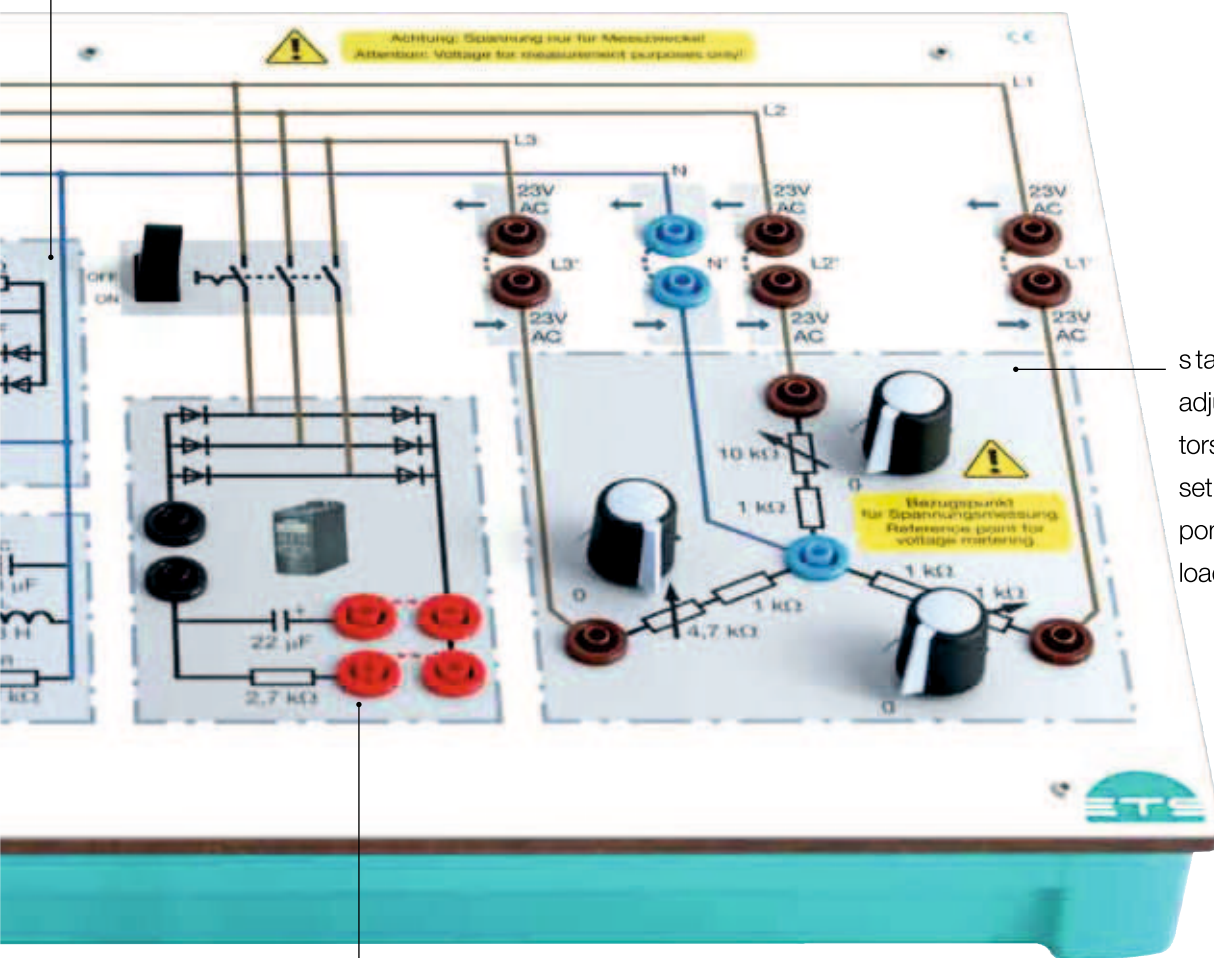

star-shaped network adjustable load resistors; all potentiometers set to left stop corresponds to symmetrical load of the network

3-phase consumer with B6u or M3U bridge rectifier

loads on the neutral conductor

symmetrical and unsymmetrical loads

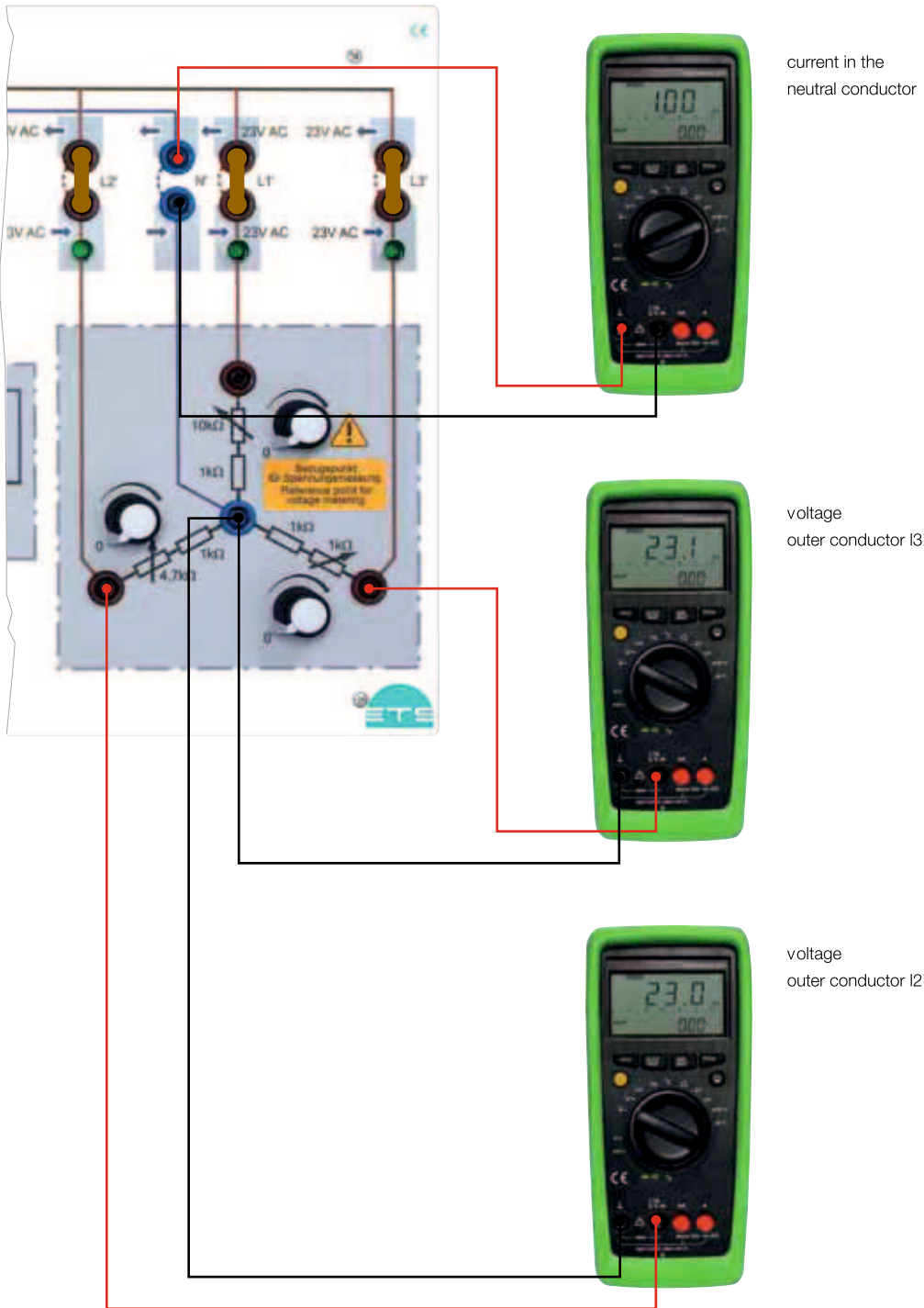

- › current in the neutral conductor with symmetrical load approx. 0 ma; current in the neutral conductor with unsymmetrical load higher than 0 ma.
- › With connected neutral conductor, the voltages in the outer conducts are approximately equal
- › Voltage offsets occur when the neutral conductor is not connected, with the lowest voltage drop on the wire with the lowest resistance and the highest voltage drop on the wire with the highest resistance.

non-linear load

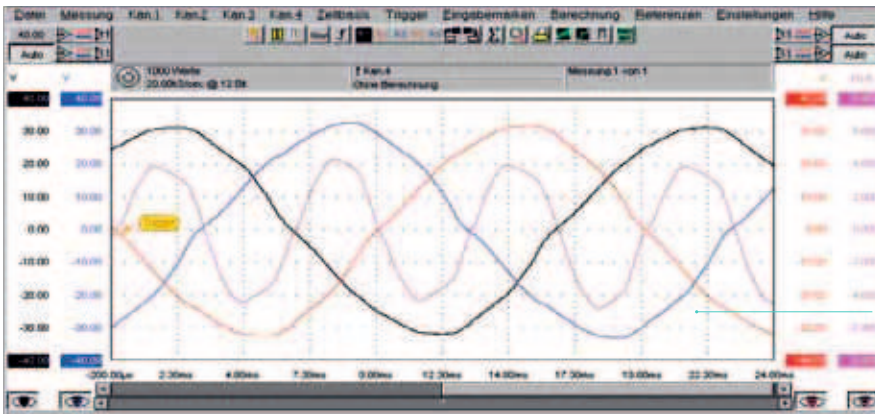
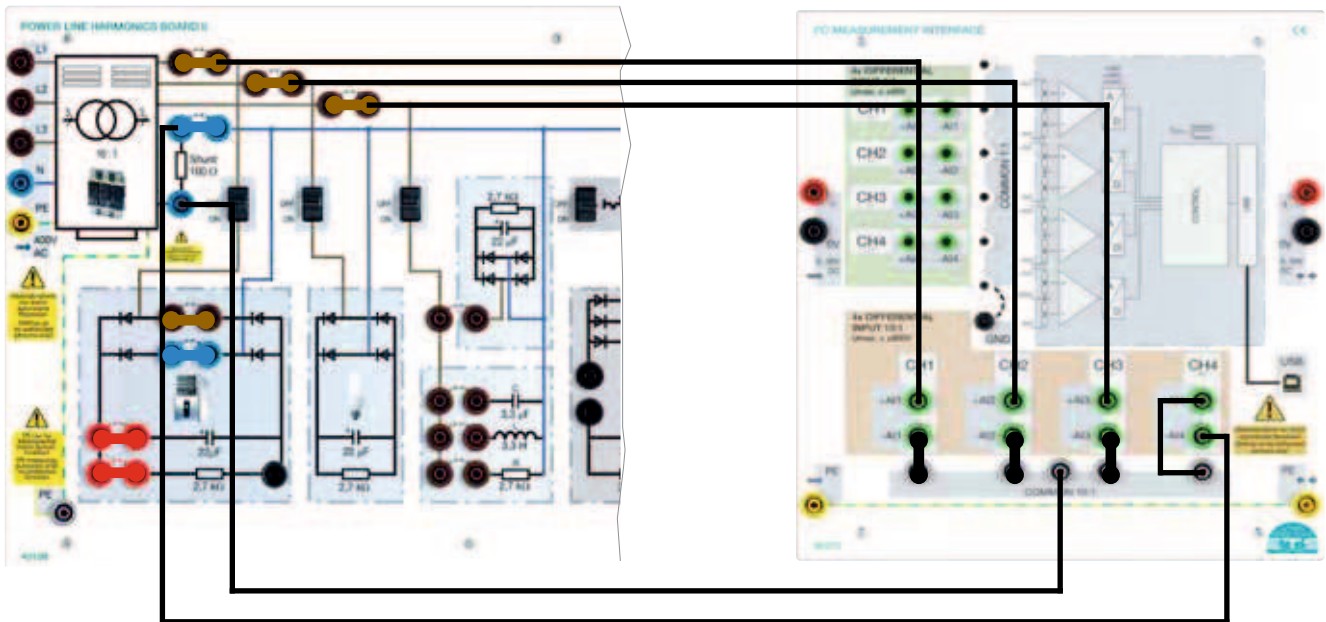

Current in neutral conductor:
display of the three outer conductors and the neutral conductor current with a load from three non-linear consumers. it shows a current with triple frequency flowing through the neutral conductor!

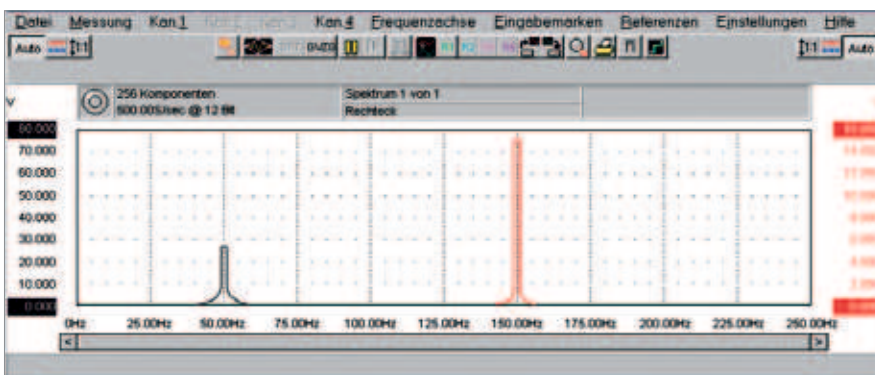

3rd harmonics 150 Hz:
each of the outer conductors, I1, I2 and I3 is loaded with one non-linear consumer. this results in a three times higher current!

loads on the neutral conductor

Measurements with the Pc Measurement interface

up to 600 V AC / 4-channel



1

the Pc Measurement interface is a four-channel measuring instrument with differential inputs. It allows safe measuring of voltages and deduced magnitudes of up to 600 v ac.

display and evaluation of the measuring results by means of a software on a connected Pc.

Learning objectives

- › Plotting and interpreting measuring charts
- › getting to know the utilization of an oscilloscope in the region of power lines
- › carrying out spectrum analyses

Technical data

- › 4 analog input channels with differential input
- › 5 MHz band width (5.000.000 samples/s)
- › sample rate of up to 5 MHz
- per channel
 - 16 bits up to 195 kHz
 - 14 bits up to 3,125 MHz
 - 12 bits up to 5 MHz
- › input 1:1
 - Measuring ranges from ± 200 mv up to ± 80 v (peak value)
 - Maximum input voltage ≤ 200 V AC
 - 2mm safety sockets
- › input 10:1
 - Measuring ranges from ± 2 v up to ± 800 v (peak value)

- maximum input voltage ≤ 600 V AC
- 4mm safety sockets
- › all inputs touch-safe 600 v , catiii
- › all inputs allow clear and easy configuration with 19mm bridging plugs
- › 4 measuring instruments in one unit
 - 12 ... 16 Bit 4-channel-oscilloscope
 - spectrum analyzer
 - transient recorder
 - voltmeter (average, true rms)
- › spectrum analyzer with distortion factor calculation

- › comprehensive trigger function
- › rapid transient recorder with 0,01 s - 500 s sampling time
- › usB 2.0 High speed (480 MBit/s)
- › optional operating voltage: 8 ... 30 v dc
- › dimensions: 266 x 297 x 85mm
- › front panel design

No.	Designation	Order No.
1	Pc Measurement interface	90272



unsymmetrical load, I1 low-resistance, neutral conductor closed



symmetrical load, neutral conductor closed

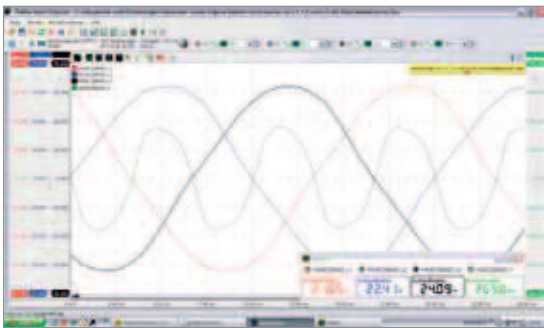

consumer connected to I1, I2 and I3 with current in neutral conductor

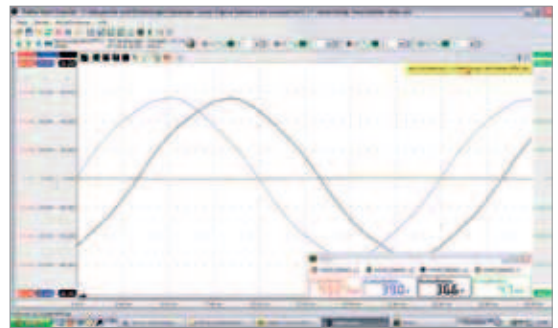

unsymmetrical load, I1 low-resistance, neutral conductor open



loads on the neutral conductor

Measurements with the 3-phase mains and power supply analyzer

Investigation: B6U bridge rectifier circuit

in industrial plants, many 3-phase equipment can be found. The figure shows the typical waveforms of the current (I1) of one phase at the input of a frequency converter with 6-pulse rectification.

Here the pulse-like charging currents of the dc link capacitor can be seen. However, their maxima lie shortly before and after the maximum of the voltage sine (referred to neutral) and therefore do not lead to a flattening but to a "spiking" of the voltage curve.

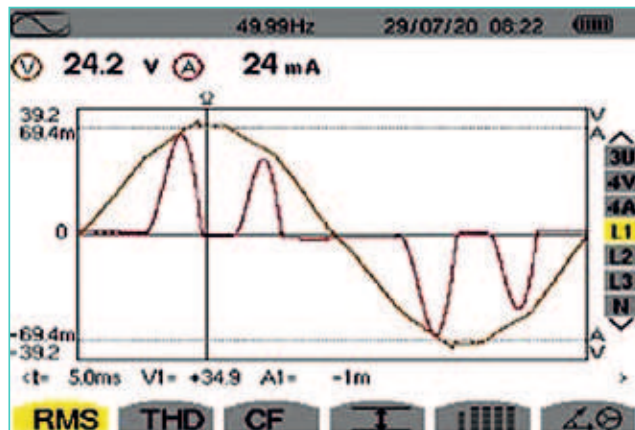

set-up plan with the main analyzer from the manual "neutral conductor load"

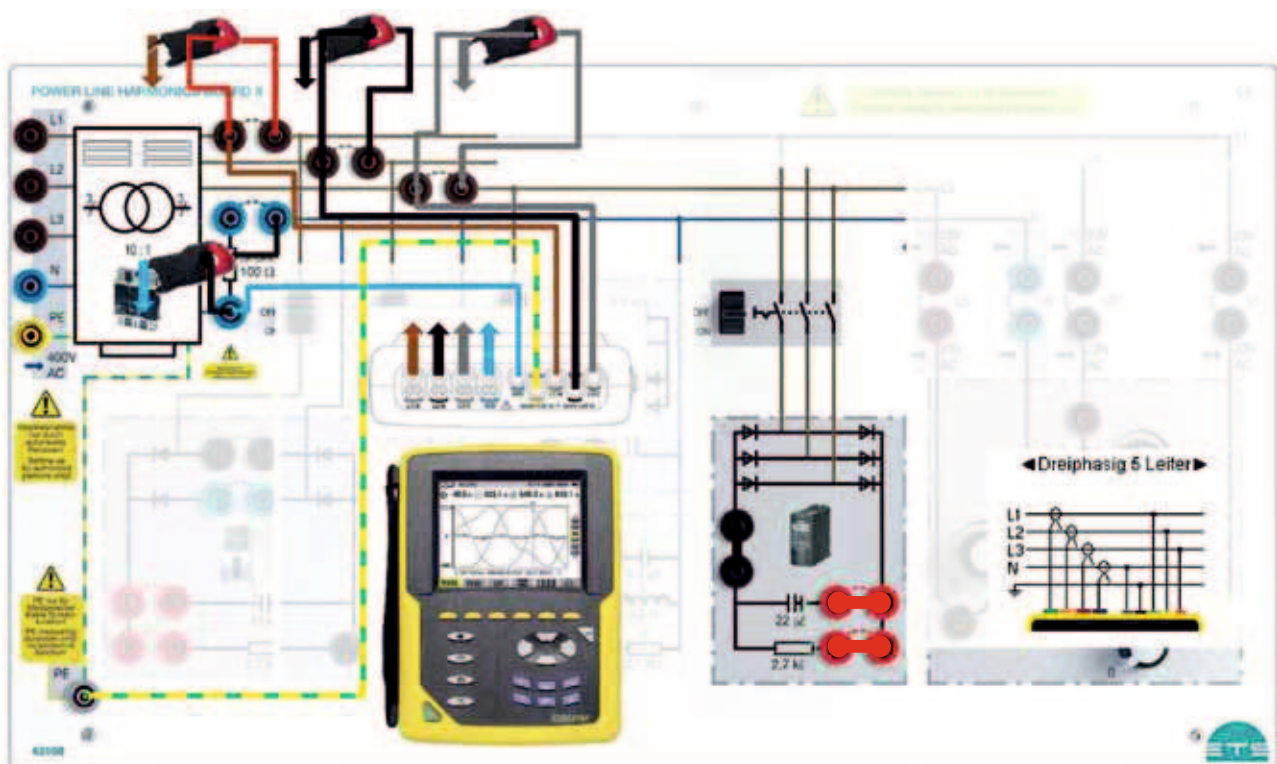



loads on the neutral conductor

courseware



Printed and digital

1



2



3



4

Manual content

- › important technical terms of the three-phase system
- › interconnection for three-phase current
- › network analysis

- › formation of harmonics, metrological investigation



TECHNOCard®

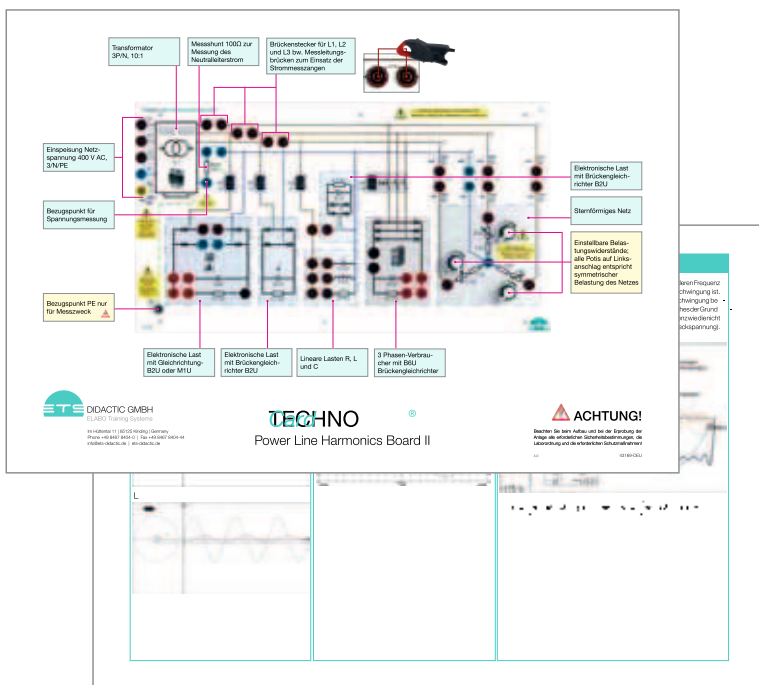

the techno cards® are a practical supplement to the training system. on them, the trainee finds a kind of knowledge store in concentrated, clear form for constant reference during practical work.

- › display board in 303mm x 426mm format
- › double-sided color design
- › robust, hard-wearing quality

5

No.	Designation	Order No.
1	set of ets ring binders	91903
2	neutral conductor load – instructor’s Manual	43140cd-eng
3	neutral conductor load – student Manual	43141cd-eng
4	neutral conductor load – Presentation aids	43142cd-eng
5	technocard® - Power line Harmonics Board ii	43169-eng

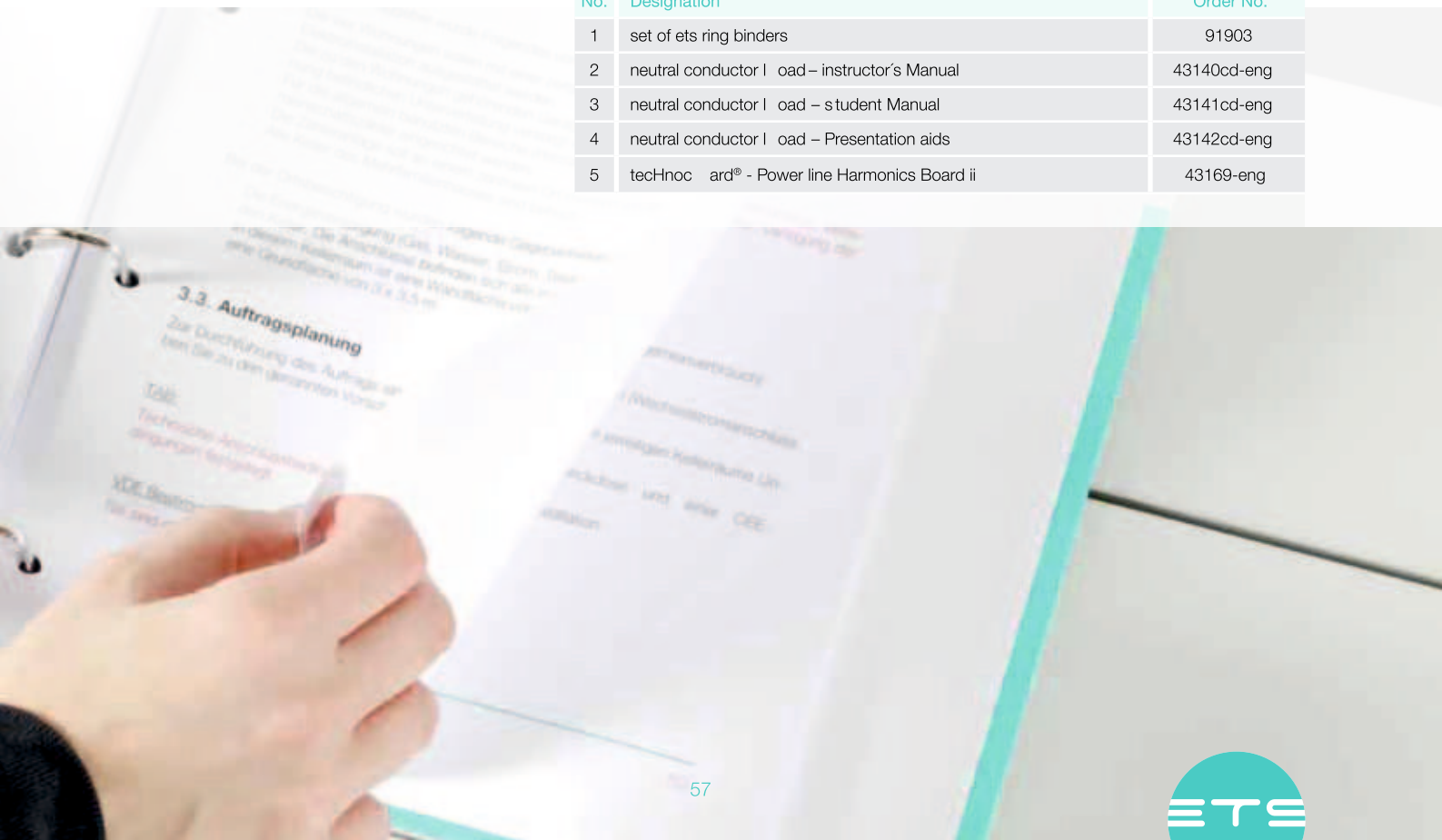





testing electrical devices
safety of electrical eQuiPMent



testing electrical devices

safety of electrical equipment | simulator Boxes for din vde 0701-0702



5

repeat testing of electrical appliances/equipment in accordance with din vde 0701-0702 can be taught with the help of the new appliance simulations under safe and realistic condition.

Learning objectives

- } gathering legal provisions
- } understanding the data on the type plate
- } describing the protection classes of the devices and assigning symbols
- } testing the suitability of the selected devices for the location
- } apply the provisions for initial and repeated tests and drawing up a flow chart of the required measurements

- } selecting and using measuring and test instruments according to din vde 0701-0702 and accident Prevention regulations dguv and interpreting the measuring results
- } Planning, executing and describing repeated tests of electrical equipment according to din vde 0701-0702 and accident Prevention regulations dguv and writing test protocols
- } systematic troubleshooting of devices

Technical data

- } the set consists of 10 appliance simulators
- } the devices correspond to consumers of protection classes i, ii and iii
- } active components in some of the consumers allow demonstrating the difference between active and passive measurements
- } faults can be simulated with toggle switches for:
 - protective conductor resistance
 - insulation resistance
 - leakage current/equivalent
 - touch current

application simulators:

- } electric iron
- } immersion Heater
- } drill Machine
- } computer
- } cable reel
- } Coffee Machine
- } cooker
- } radio
- } Power supply
- } Washing Machine
- } connecting line with appliance coupler 2 m
- } connecting line with european coupler 2 m

set of appliance simulators



1

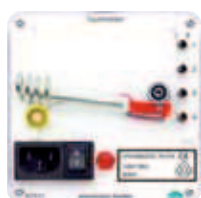

2



3



4



5



6



7



8



9



10



12



11



13

No.	Designation	Order No.
n.iii.	set of appliance simulators	42140
1	appliance simulator – electric iron	42130
2	appliance simulator – immersion Heater	42131
3	appliance simulator – drill Machine	42132
4	appliance simulator – computer	42133
5	appliance simulator – c able reel	42134
6	Appliance Simulator – Coffee Machine	42135
7	appliance simulator – cooker	42136
8	appliance simulator – radio	42137
9	appliance simulator – Power supply	42138
10	appliance simulator – Washing Machine	42139
11	t est case with appliance tester	90227
12	c ase – storage device simulators	42145-Z01
13	Plate for Holding the Modules	20999

Protective Measures

courseware



Printed and digital

1



2



3



4

Manual content

- } introduction
- } test procedure
- } Definitions
- } tasks
- } fault tables

No.	Designation	Order No.
1	set of ets ring binders	91903
2	t esting electrical devices – instructor’s Manual	42150cd-eng
3	t esting electrical devices – s tudent Manual	42151cd-eng
4	t esting electrical devices – Presentation aids	42153cd-eng

TECHNOCard®

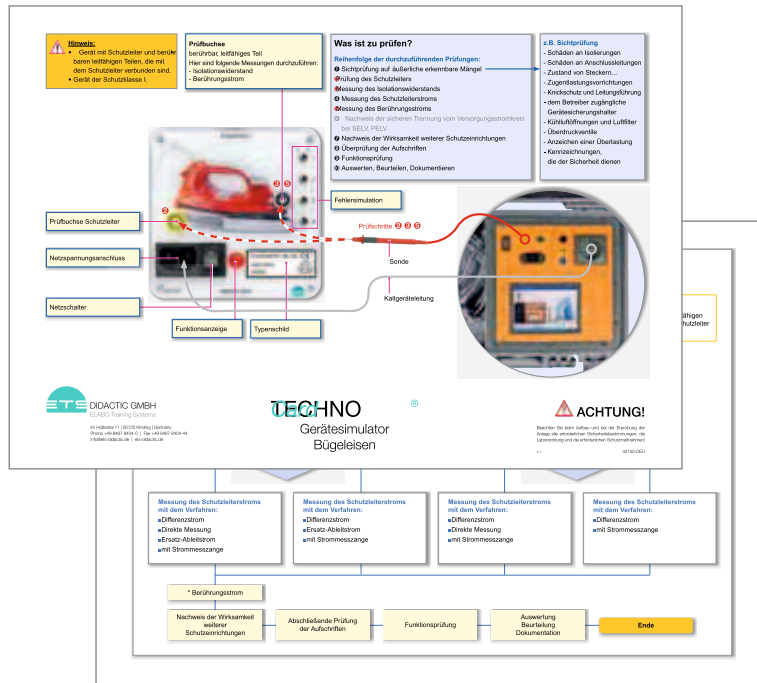

the techNoc ards® are a practical supplement to the training system. on them, the trainee finds a kind of knowledge store in concentrated, clear form for constant reference during practical work.

- › display board in 303mm x 426mm format
- › double-sided color design
- › robust, hard-wearing quality

5

No.	Designation	Order No.
5	techNoc ards® - appliance simulator electric iron	42155-eng
n.ill.	set of techNoc ards® - appliance simulator	42154-eng
n.ill.	techNoc ards® - appliance simulator immersion Heater	42156-eng
n.ill.	techNoc ards® - appliance simulator drill Machine	42157-eng
n.ill.	techNoc ards® - appliance simulator computer	42158-eng
n.ill.	techNoc ards® - appliance simulator cable reel	42159-eng
n.ill.	techNoc ards® - Appliance Simulator Coffe Machine	42160-eng
n.ill.	techNoc ards® - appliance simulator cooker	42161-eng
n.ill.	techNoc ards® - appliance simulator radio	42162-eng
n.ill.	techNoc ards® - appliance simulator Power supply	42163-eng
n.ill.	techNoc ards® - appliance simulator Washing Machine	42164-eng

testing electrical devices

Projects



1

Learning objectives

- › setup and commissioning of cross and two-way circuits
- › Mounting of meter cabinet and sub-distribution
- › inspection according to din vde 0100-600

Project 1:

› the company does not want to use the basement room from project 1 for storage any longer, but to rent it to another company. f or this purpose, the electrical installations have to be modified. The room installations are planned for control via a meter cabinet with t-n-c-s system and subdistribution. the cross circuit established in project 1 is laid idle and replaced by a pushbutton circuit. f urthermore a 16 a cee socket has to be installed and connected. the electrical installation has to be made in iPX4 and the subdistribution in iP30. c alculat ion and drawing of the distribution plan is made by

means of a planning software. Mounting of the installations has be effected in compliance with the provisions for protective areas.

Project 2:

› a company wants to use an empty basement room for storage. f or this purpose, a lighting shall be installed consisting of two fluorescent lamps which are to be actuated from three access doors. the room can be ventilated, but not heated. as the room is only intended for storage use, the electrical installations are mounted on the surface. the installation

material to be selected should be suitable for damp locations.

Project 3:

› the system mounted in Project 2 has to be inspected according to the din vde regulations with submission of a measuring and inspection protocol.

installation material sets



2 and 3



6

grid Plates/screws/dowels

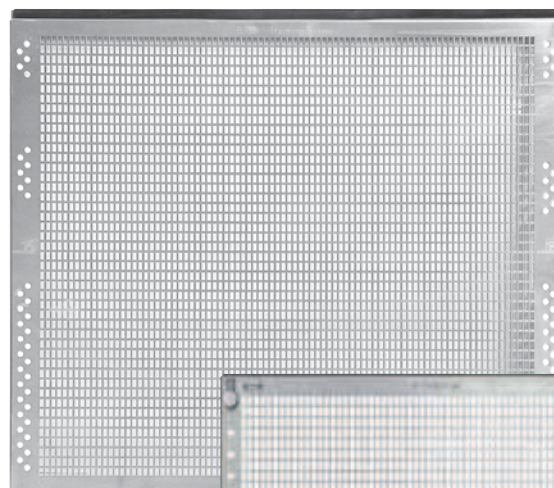

4

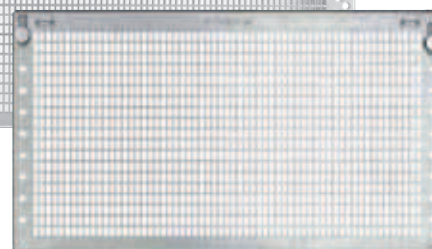

5

Components and equipment set consisting of:

- > 2 x off and changeover switches
- > 1 x cross switch
- > 1 x light strip
- > 1 x fluorescent tube
- > 1 x junction box
- > 3 x push button
- > 1 x socket
- > 1 x cee socket
- > 1 x small distribution box aP, 3-row
- > 1 x residual, current circuit breaker
- > 1 x lss B16a, 3-pole
- > 1 x lss B16a ,1-pole
- > 1 x lss B10a, 1-pole
- > 1 x remote switch
- > 1 x phase bar
- > 1 x main line branch terminals
- > 1 x busbar with terminals
- > 1 x set of accessories

No.	Designation	Order No.
1	Mobile learn trainer (Mlt) as a double workstation for project work (accessories)	89200
2	installation and material set: components and equipment set	42213
3	installation and material set: cable and wiring set	42214
4	interchangeable perforated plate wall for hanging in front of experiment frames of the Mlt (766 x 687 x 45 mm)	89217
5	din a4 interchangeable perforated sheet wall for hanging up experiment frame (540 x 297 mm)	89214
n.ill.	set of dowels 5/10 (100 s tk./set)	0d90203
n.ill.	set of dowels 5/5 (250 s tk./set)	0d90204-01
6	set of assembly accessories, consisting of: - special dowels 5 x 5 mm, 100 s t. - special dowels 5 x 10 mm, 100 s t. - screws 3,5 x 12 mm, 100 s t. - screws 3,5 x 20 mm, 100 s t. - screws 3,5 x 30 mm, 100 s t.	90055

installation technology

courseware



Printed and digital

1



2



3



4



5

Manual content

- › installation of basement room
- › installation of a distributor
- › testing of the installation and creation of an acceptance protocol

No.	Designation	Order No.
1	set of ets ring binders	91903
2	If 2 – installation technology – instructor's Manual	42201cd-eng
3	If 2 – installation technology – student Manual	42200cd-eng
4	If 2 – installation technology – commissioning and troubleshooting	42202cd-eng
5	If 2 – installation technology – Presentation aids	42203cd-eng

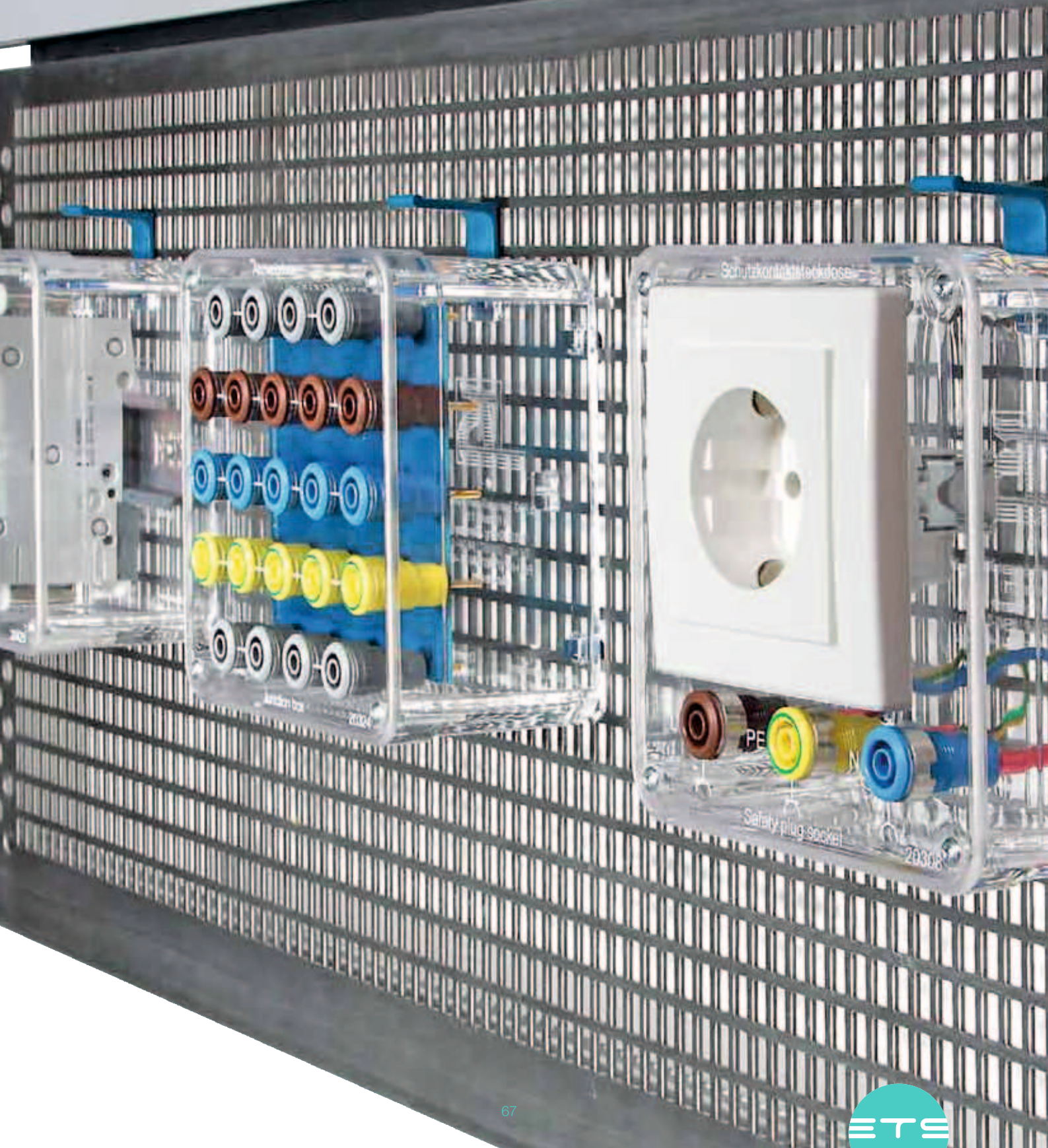





Measuring and test instruments

Measuring and testing

Measuring and test instruments

digital multimeter, analog multimeter



1

2



3

Professional digital multimeter

The multimeter for training

the professional multimeter is designed to safely measure dc & ac voltages up to 1000 v in the measurement category cat iii 600 v or cat iv 300 v , according to the specifications of IEC/EN61010-1.

the multimeter, equipped with a mechanical protection against incorrect operation, has a large, high-resolution display with bar graph and an AutoPowerOff function to save batteries.

ideal for laboratory use in school and training.

Functions

- › Mechanical safeguard against faulty operation
- › ac and dc voltage up to 1000 v
- › ac and dc current values up to 10 a
- › resistance tests with 60 M Ω and continuity tester
- › frequency and capacitance
- › temperature with Pt -1000 sensor
- › diode test and duty cycle
- › auto-ranging
- › MaX/Min and data Hold
- › autoPoweroff

Analog multimeter for training

the multimeter meets the requirements on didactic as well as professional training and for balancing and service work as well.

Functions

- › voltages measuring ranges 0...100/300 mv/1 v – 0 ... 3/10/30/100/300 v – / ~
- › ac current range 0 ... 100 ma/1/10/100 ma/1/3 a – ~
- › optional settings:
zero left/centre
- › excellent overload capacity, automatic battery switch-off
- › accessories

No.	Designation	Order No.
1	digital multimeter	90600
2	storage case "universal" for eight measuring instruments	90275
3	analog multimeter	90200



Measuring and test instruments

voltage tester



Technical data

- › dc voltage: 12 - 690 v
- › ac voltage: 12 - 690 v
- › Continuity test: 0 - 400 k Ω
- › Phase rotation: 100 - 690 v

1



direction of rotation tester



2

Technical data

direction of rotation tester for three-phase networks and for non-contact testing of motor direction of rotation.

- › voltage range 40 - 600 v
- › frequency range: 15 - 400 Hz
- › operating time: continuous
- › Power supply: over 9 v battery

No.	Designation	Order No.
1	voltage tester	90285
2	direction of rotation tester	90276



Measuring and test instruments

Leakage current clamp meter



1

Technical data

- } Resolution of 10 μ A
- } current unbalanced between the phases
- } one disengageable harmonic filter
- } current up to 100 a

Measuring ranges

- } Current AC: 10 μ A – 100 A
- } voltage ac: 0.1 v – 600 v
- } voltage dc: 0.1 v – 600 v
- } Resistance: 0.1 Ω – 1k Ω
- } f requency: 0.1 Hz – 1 kHz

No.	Designation	Order No.
1	Leakage current clamp meter	90605



Measuring and test instruments

installation tester



Installation tester for DIN VDE0100 multifunctional device for initial and repeat testing

- › ac voltage: measuring range 500 v
- › low resistance measurement: 0.01...39.9 Ω
- › insulation resistance measurements: test voltage: 50 - 100 - 250 - 500 - 1000 v Insulation: 10 kΩ - 2 GΩ
- › live circuit detection: prevents test if extraneous voltage before test starts
- › loop impedance measurement: phase to ground
- › line impedance: phase to neutral
- › rcd circuit breaker test: a, ac, f, B, B+ and ev type
- › Tripping time test (ΔT): current settings 10, 30, 100, 300, 500 ma tripping current
- › earth resistance (r_e): measuring range 0...40 kΩ. selective earth measurement with current clamp.
- › Harmonic analysis up to 50th order, with current clamp 90228
- › Rotary field direction
- › internal memory
- › documentation via software
- › transport bag
- › Batteries, charger, test lead set, probe for remote control, software

Optional current clamp for installation tester

- › for selective earth measurement
- › current measurement for network analysis
- › 5 ma – 200 a

No.	Designation	Order No.
1	installation tester for din vde 0100 multifunction device	90226
2	current clamp for installation tester	90228



Measuring and test instruments

installation tester



1



2

Technical data MTECH (1)

- › ac voltage:
measuring range: 500 v
- › low impedance measurement:
measuring range: 0.01...99.9 Ω
- › insulation resistance measurements: test voltage:
50 – 100 – 250 – 500 – 1000 v
Isolation: 10 kΩ – 300 MΩ
- › live circuit detection
- › loop impedance measurement
- › line impedance: phase to neutral
- › rcd circuit breaker test:
type a, ac, f, B, B+
- › Tripping time test (ΔT):
current settings:
10, 30, 100, 300, 500 ma
- › earth resistance test (r_e):
measuring range 0...10 kΩ.
- › Phase sequence
- › internal memory function
- › documentation of software via Pc
- › visualisation of the device via Pc

Technische Daten MXTRA (2)

- › ac voltage:
measuring range 500 v
- › low impedance measurement:
measuring range: 0.01...99.9 Ω
- › insulation resistance measurements: test voltage:
50 – 100 – 250 – 500 – 1000 v
Isolation: 10 kΩ – 300 MΩ
- › live circuit detection
- › loop impedance measurement: phase to earth
- › line impedance: phase to neutral
- › rcd circuit breaker test:
types a, ac, f, B, B+
- › Tripping time test (ΔT):
current setting:
10, 30, 100, 300, 500 ma
- › earthing resistance measurements (r_e):
measuring range 0...10 kΩ.
- › Phase sequence measurements
- › tests in it systems: insulation monitoring devices
- › testing of residual current monitoring devices
- › documentation of software via Pc
- › visualisation of the device via Pc



3

Technical data

Profitest INTRO (3)

- › Measurement of r_{lo} , Z_{1-Pe} , Z_{T-n} , r_{iso} , r_e , ΔU , rotating field and voltage
- › offset management $r_{1-Pe} / r_{n-Pe} / r_{T-n}$
- › direct selection of measuring functions via rotary switches
- › rod measurement type a, ac, f, B, B+, ev, Mi, g/r, srcds, Prcnds
- › display of allowable standardized fuse types for electrical installations
- › Measuring the phase sequence (phase sequence: highest interlinked voltage)
- › Measurement of the touch voltage via finger contact
- › connection of rfid or barcode scanners
- › individual measurement data memory and generation of a memory structure
- › Help function with circuit diagrams
- › Bidirectional data exchange per usB, dds-cad, epinstroM
- › Measurement category cat ii 600 v / cat iv 300 v
- › international control guidance (12 languages)
- › etc software (electrical testing center), among other things, for creating tree structures and documentation according to ZveH

No.	Designation	Order No.
1	Installation tester for DIN VDE 0100 Profitest MTECH	90221
2	Installation tester for DIN VDE 0100 Profitest MXTRA	90222
3	Profitest INTRO – Test instrument for DIN VDE 0100-600/iec 60364-6	90223

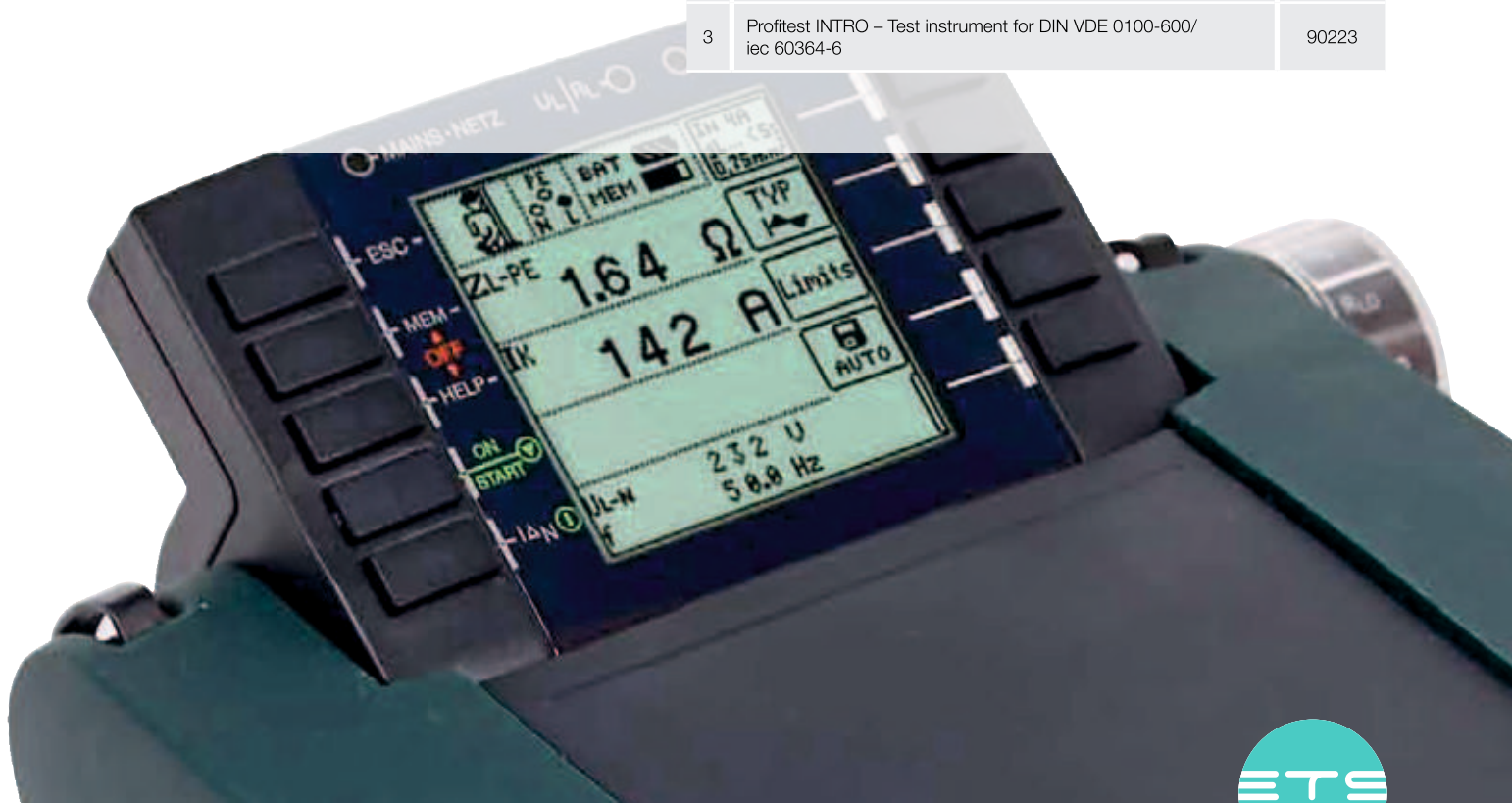

vde Measuring instruments

appliance tester in Protective case for testing

according to din vde 0701-0702 and accident Prevention regulations dguv



1

Learning objectives

- › selecting and applying measuring and test equipment for measurements according to: din vde 0701-0702 and accident prevention regulations dguv
- › interpreting measurement results
- › apply the regulations for initial and repeat testing and draw up a flow chart for the required measurements

Technical data

- › accident Prevention regulations dguv , din vde 0701-0702: testing of electrical appliances/equipment, din vde 0751 (en 62353): testing of medical electrical devices, such as hospital beds etc.
- › features: indication and operation via large color touch screen (14,1cm), direct test sample/customer entry via touchscreen keypad, one tester for testing devices acc. to vde 0701-702 and vde 0751 type B, Bf , cf tests
- › individual – easy setup of individual test procedures as template, automatic manual and auto-configurable testing procedure, measuring result with "pass/fail" indication, help function and schematic connecting diagrams, 2 x usb interface for data exchange, rfid reader/writer and external keyboard, 1 x rs 232 interface for barcode scanner, printer/writer and sd-card slot

- › Measurements: Measuring the protective conductor resistance, measuring the insulation resistance, protective conductor current/contact current, leakage current, load current

No.	Designation	Order No.
1	appliance tester in protective case for testing according to din vde 0701-0702 and accident Prevention regulations dguv	90227



Measuring and test instruments

3-phase mains and power supply analyzer



Set consisting of power analyzer and 4 current clamps with current measuring range starting at small currents (from 5 mA)

Technical data

- › Measurements:
 - voltage: 2 v - 1000 v
- › Power: 5 ma - 100 a with the supplied current clamp (max. 10 ka)
- › f frequency: 40 Hz - 69 Hz
- › crest factor: 1.0 - 99,0
- › Power: Watt, var, va, Pf , cos φ, tan,
- › Harmonics voltage: - 50 order
- › Harmonics current: - 50 order
- › Phase diagram
- › flicker
- › transient detection
- › inrush current
- › oscilloscope functions: dc, ac, ac+dc, peak-to-peak, Hz, duty cycle, phase
- › Pulse width, crest factor:
- › recoding: v/a/HZ, power, harmonics, oscilloscope function

Features

- › Measured value display in real time
- › voltage and current inputs with color markings
- › connection via Pc interface
- › automatic recognition of the used current transformers
- › energy measurement P, Q1, s and total and per phase
- › simultaneous operation in multiple modes
- › viewing the data during recording
- › Measurement according to en50160 directly adjustable in the software

1

No.	Designation	Order No.
1	Power analyzer 3-phase incl. current clamps	90291



MeasureMent and test instruMents

thermal imager



Technical data

image performance:

- field of view 20° x 20°
- thermal sensitivity: 80 mK, 30 °C
- frame rate: 9 Hz
- focus: auto/manual

infrared sensor features:

- detector type uFP a microbolometer, 8 - 14 µm
- sensor size: 160 x 120

Measurement and image display:

- ir / true image/image in image (320 x 240 pixels)
- temperature range: -20 °C bis +250 °C
- display: 2.8 "

image storage:

- external memory: 2 GB sd card
- file format: png
- storage capacity: max. 4000 images

data transmission:

- PC connection: USB 2.0

Included in delivery:

thermal imaging camera, carrying case, battery pack, charger, sd card, USB cable, Bluetooth headset, protocol software, user manual.

Features

- } large 2.8 inch screen
- } roller shutter
- } Bluetooth connection to other measuring devices
- } standard AA batteries
- } camreport software

No.	Designation	Order No.
1	thermal imager	90302



stay connected
with us on social Media

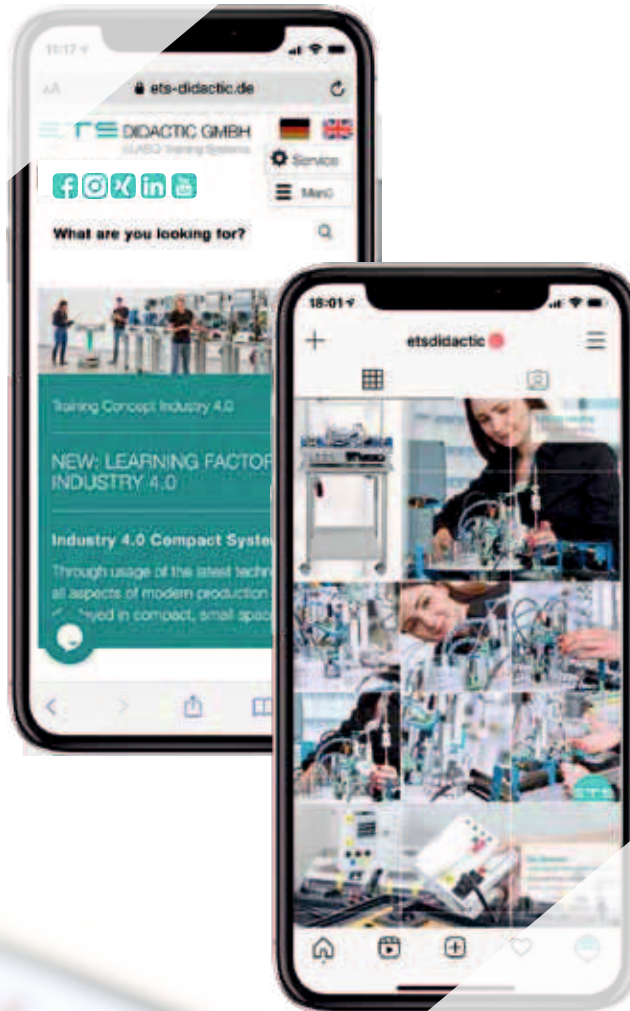



didactic solutions from ets

catalog „installation technology“

ETS DIDACTIC GMBH

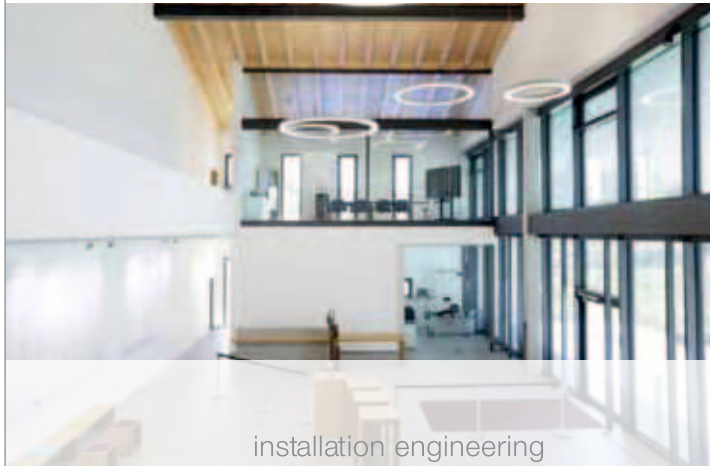

installation engineering

lighting technology



catalog „Building communication“

ETS DIDACTIC GMBH



building communication

commissioning of VoIP and classic call systems



Quality is the Measure of all success

inspiring technologies

ETS DIDACTIC GMBH is a symbol of high quality and outstanding flexibility. This means that ETS DIDACTIC products are convertible, they can – thanks to the modular conception and the versatile range of accessories – be quickly and efficiently matched to changed requirements and extended nearly without limits.

our high quality standards refer not only to the products from ets didactic, but especially also to the quality of the training that customers achieve thanks to the use of ets didactic products. and in this, we also include the process quality: ets didactic supports procedures during the training that are as problem-free as possible.

The solutions offered by ETS DIDACTIC can be matched to individual customer requirements to a great extent. customers of ets didactic are supported and accompanied in the successful implementation of their training objectives by a comprehensive range of services.





Please contact us

We are always ready to assist you



Katharina Gietl
service center



Monday to Friday from 7.45h to 16.30h

Phone: +49 8467 / 8404-0

email: sales@ets-didactic.de

We accompany you and are at your side with active advice. Whether you need information, or some advice in advance of making an investment, or have questions regarding the daily use of the products:

Contact us –
we are ready to assist:

ets didactic gMBH
service-center
im Hüttental 11
85125 Kinding / germany

Phone +49 8467 8404-0
f ax +49 8467 8404-44

sales@ets-didactic.de
www.ets-didactic.de



Customer-oriented solutions

- › Presentation, product demonstrations and on-site consultancy
- › support in the selection of educational systems according to the syllabus requirements
- › Matching of the training systems to customer requirements
- › Working out room concepts
- › designing ergonomic workstations

Experience

- › comprehensive range of innovative products
- › systems and solutions from our own (in-house) production
- › development and design, technical training systems
- › Quality right from the consultancy up to delivery and onward
- › trainer workshops / in-house training / Webinars
- › references world-wide
 - industrial educational institutions
 - vocational schools / technical schools
 - chambers of crafts
 - technical colleges / universities

We support you

- › installation and commissioning of the systems on-site
- › technical support
- › Warranty and repairs
- › instruction and training
- › further education, training, seminars
- › comprehensive product documentation
- › courseware for instructors and trainees

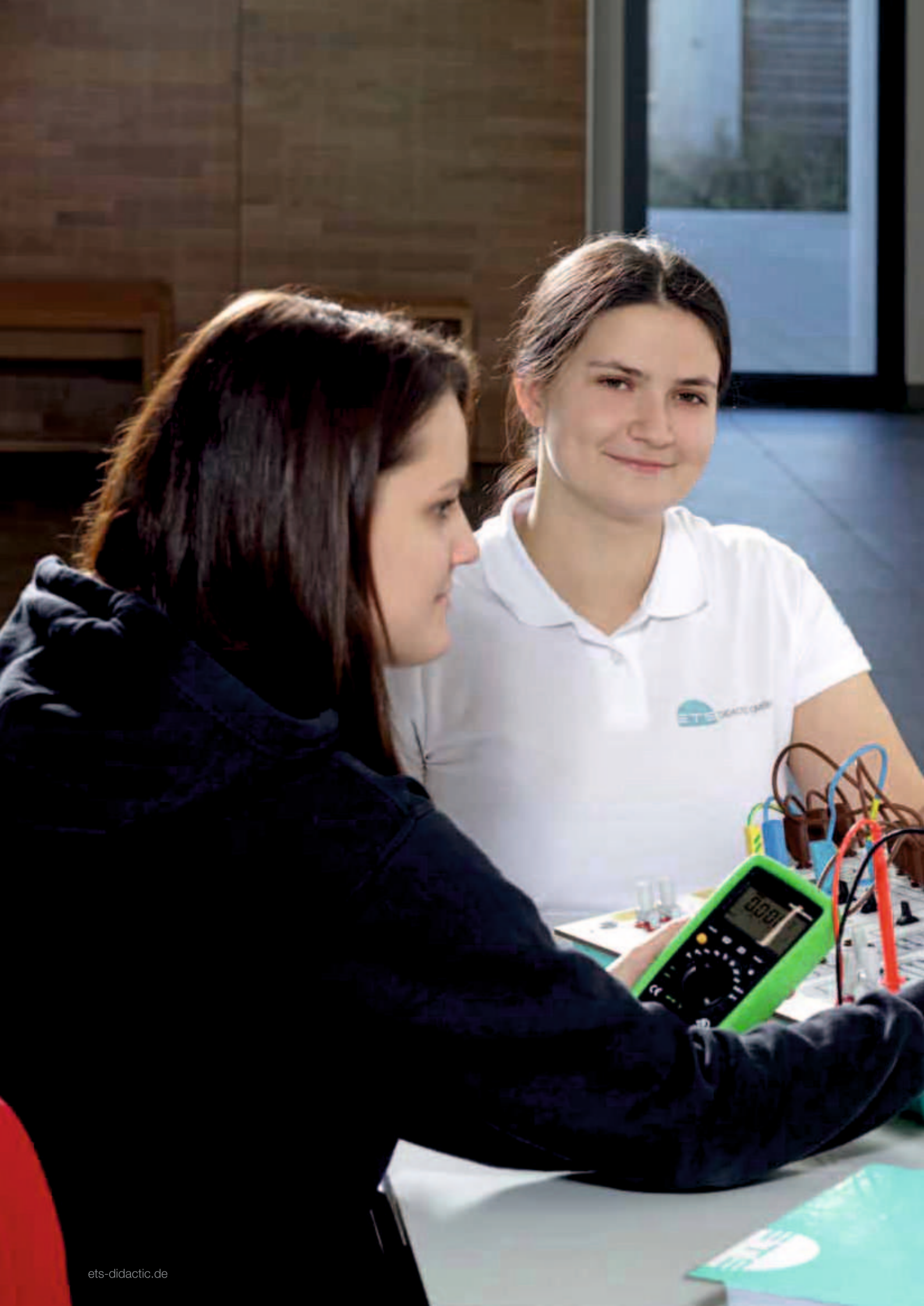

your enQuery

We are always ready to assist you

via the following QR code you are welcome to download the enquiry form and send it filled out via e-mail or fax to ETS.



Qty	Description	Order No.	Qty	Description	Order No.
	Energy supply system BST [®] - Student Manual	430100-ENG		TECHKOCard [®] - Appliance Computer	42198-ENG
	Energy supply system BST [®] - Presentation Aids	430100-ENG		TECHKOCard [®] - Appliance Cable Tool	42199-ENG
	TECHKOCard [®] - Overview	430100-ENG		TECHKOCard [®] - Appliance Safety Monitor	42199-ENG

ETS DIDACTIC GMBH

ETS DIDACTIC GMBH

ETS DIDACTIC GMBH

Im Hiltorf 11
85125 Kinding | Germany
Phone +49 89 607 8004-0
Fax +49 89 607 8004-44

We would like:

Contact by telephone Information on seminars Telephone Video

Consultation on site Receive an offer about ...

E-Mail

YOUR ENQUIRY

Safety of electrical installations and devices

Name / Function

Employ Institution / Authority

Street / Postcode

Post code / Phone

Qty	Description	Order No.	Qty	Description	Order No.
	Safety Measure Board	43400		Network Systems/Protective Measures - Instructor's M	433100-ENG
	Set of ETS ring breakers	43700		Network Systems/Protective Measures - Student M	433100-ENG
	Electrical Protective Measures - Instructor's Manual	434100-ENG		Network Systems/Protective Measures - Present. Aid	433100-ENG
	Electrical Protective Measures - Student Manual	434100-ENG		TECHKOCard [®] - Main Distribution Board I	43320-ENG
	Electrical Protective Measures - Presentation Aids	434100-ENG		TECHKOCard [®] - Sub-Distribution Board I	43321-ENG
	TECHKOCard [®] - Electrical Protective Measures	43410-ENG		TECHKOCard [®] - Insulator Monitor Board I	43322-ENG
	Main Distribution Board I	43300		TECHKOCard [®] - FCD Board Type A 300 mA	43323-ENG
	FCD Board 200mA	43306		TECHKOCard [®] - FCD Board Type A 300 mA	43324-ENG
	FCD Board 200mA	43306		TECHKOCard [®] - FCD Board Type A 50 mA	43325-ENG
	FCD Board 20mA	43307		TECHKOCard [®] - FCD Board Type B 30mA	43326-ENG
	FCD Board 20mA 50	43308		TECHKOCard [®] - FCD Board Type B 30mA	43327-ENG
	FCD Board 20mA 10 P	43309		BST [®] Protective Measures	43308
	Sub-Distribution Board I	43320		BST [®] Insulation Technology	43304
	Insulator Monitor Board I	43324		Energy supply system BST [®] - Instructor's Manual	430100-ENG





Scarica il catalogo completo



Cataloghi digitali, alberi felici:
scegli **Abintrax** che con **mydidactstore**,
abbraccia la sostenibilità!

Concessionario

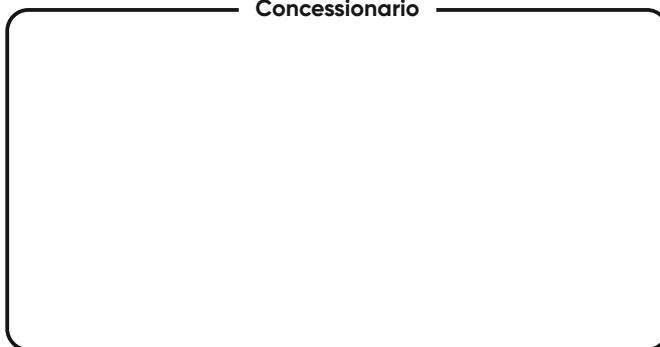

Abintrax s.r.l.
Via Marina del Mondo, 62 | 70043 Monopoli (Ba) Italy
tel. +39 080 2149700 | www.abintrax.com | info@abintrax.com

www.mydidactstore.it