



Domotica con tecnologia KNX

Progettazione e gestione di sistemi di domotica e di automazione intelligente degli edifici con moduli KNX

ETS DIDACTIC



KNX

Configuration and commissioning of KNX Systems

another way to care

Visita il nostro store



www.mydidactstore.it



KNX SYSTEMS

Configuration and Commissioning of KNX Systems



CONTENTS

Didactic solutions

Information

Editorial	4
Visit ETS in the Valley of River Altmühl.....	6
Approach and Room Concept.....	8
People and Technology.....	10
Workshops with ETS	13
The ETS Training Concept	14

Fundamentals of KNX

KNX Professional Programming Board II.....	20
KNX Heating control	24
KNX Software.....	26
KNX IoT Visualization Server	28
KNX Touch Panel.....	32
KNX Universal Sensor Board	34

Smart lighting

Smart Home Lighting Set	38
Bulb Socket Board	39

Weather

KNX Weather Station.....	42
Blinds Board.....	44

System overview

KNX Weather Station.....	42
--------------------------	----

KNX Topology

KNX Network.....	60
Line coupler.....	62
Gateway DALI lighting control.....	66

KNX BST®

BST® Building System rainer	70
KNX Project Dimming	72
KNX Project Heating Control.....	74
Training package Smart Home Manager	76
BST® Building System rainer, Smart Home Manager	78
LOGO!.....	80

Information and Consulting

Quality is the Measure of all Success	86
Please contact us	88
Your Enquiry	91



PEOPLE AND TECHNOLOGY – A PERFECT MATCH

Technology to inspire you: understanding – comprehending – applying

ETS DIDACTIC is your partner for in-house and institutional education and training in the professional fields of electrical engineering and metal technology.

Topics such as Industry 4.0, electrical engineering, power electronics, pneumatics, drive technology, automation technology, sensor technology, bus systems, mechatronics, transmission technology and the complete scope of building systems engineering including renewable energies are presented as a training system. With the help of well thought-out learning-oriented hardware and accompanying courseware, the specialist skills are quickly learned, grasped by hands and lead to didactic learning success in a goal-oriented manner.

The service spectrum of ETS DIDACTIC ranges from the provision of didactic hardware, courseware and software to the planning and equipping of the complete training rooms. ETS meets all requirements with practice-oriented workshops on the complete spectrum of technical professions for lecturers, trainers and instructors in a specially built modern training center or online.

Vocational schools, training centres of the ICC, Chamber of Crafts or the industry, polytechnics and universities are among the long-standing customers of ETS DIDACTIC.



Welcome to ETS DIDACTIC

ETS DIDACTIC is the pioneer and market leader in the development, manufacture and sales of electrical, automation and mechatronic workstations for training and instruction.

ETS DIDACTIC counts among the leading international manufacturers in the market environment. Located in Kinding, in the beautiful natural reserve of Altmühltal – high-quality products and solutions are developed and manufactured for you.

In the training centre in Kinding, the focus is on the practical application of the systems and fast learning of new technologies by the customers.

The knowledge, experience and the above-average personal involvement of the motivated employees of ETS DIDACTIC are vital factors for the company's efficiency.



Sven Urban
Managing Director



Udo Urban
Managing Director
(Founder)



MADE IN GERMANY

Visit ETS in the Valley of River Altmühl

Welcome to Germany - Bavaria

The Altmühltal Nature Park is one of the largest in Germany and offers a thousand ideas for families, history fans, cultural discoverers and nature lovers.

You can travel to our workshop in Kinding-Haunstetten by train. The regional train station Kinding/Altmühltal is located directly on the ICE route between Nuremberg and Munich. The regional express trains of Deutsche Bahn stop every two hours. The journey from Kinding to Ingolstadt takes 17 minutes, to Munich 1 hour 15 minutes and to Nuremberg only 27 minutes.

Local cab companies are available to take you from Kinding to Haunstetten. We will be happy to assist you with the organization.

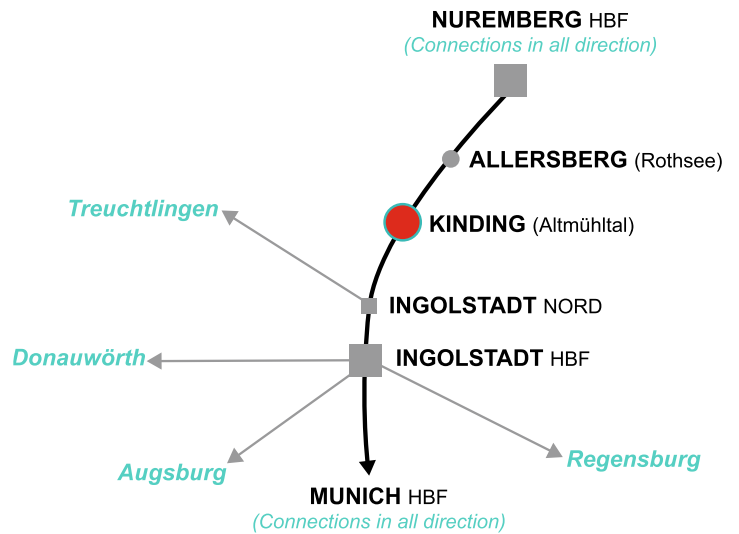

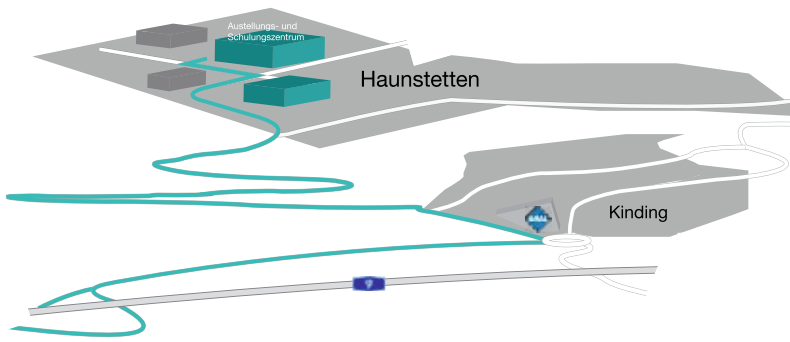

Kloster Weltenburg



Naturpark Altmühltal

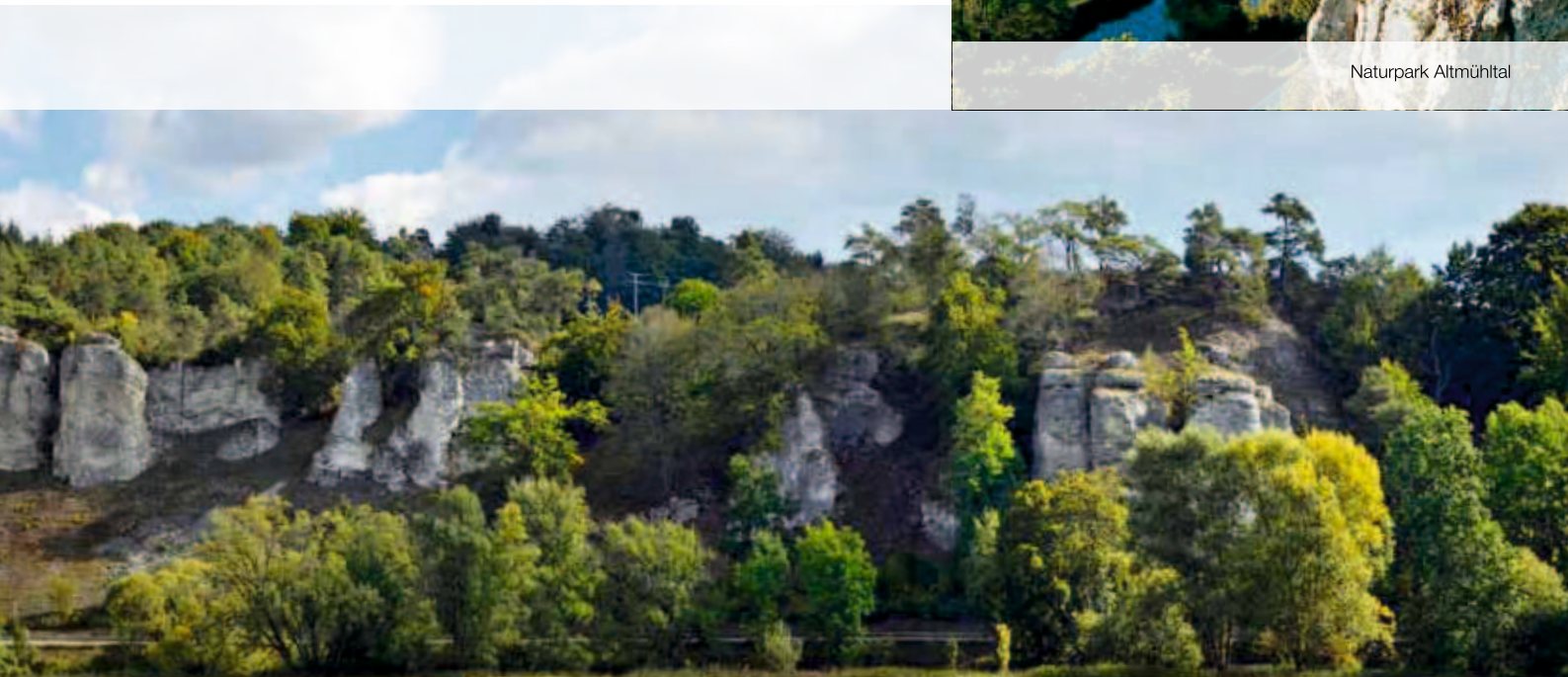

APPROACH AND ROOM CONCEPT

To plan a custom-made room concept with you, we proceed in the following steps:

- › A good room concept is based on professional advice. The technical consultants of ETS DIDACTIC are pleased to support you in the local planning phase. Benefit from their technical expertise and experience.
- › Planning a room concept is more than selecting the furniture. Each room concept is adapted and developed for the local requirements of the customer.
- › Taking into account the learning contents an equipment list can be set up. As soon as the extent is defined, the storage equipment is optimised and designed.



Analysis

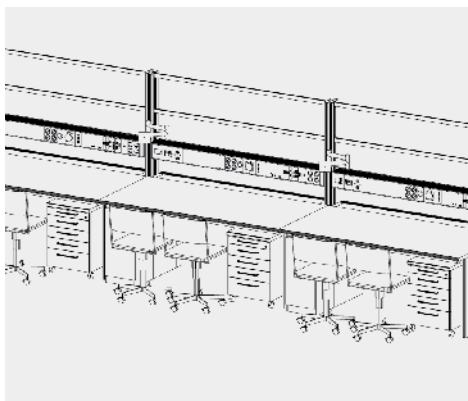

Conception



Consulation / Planning

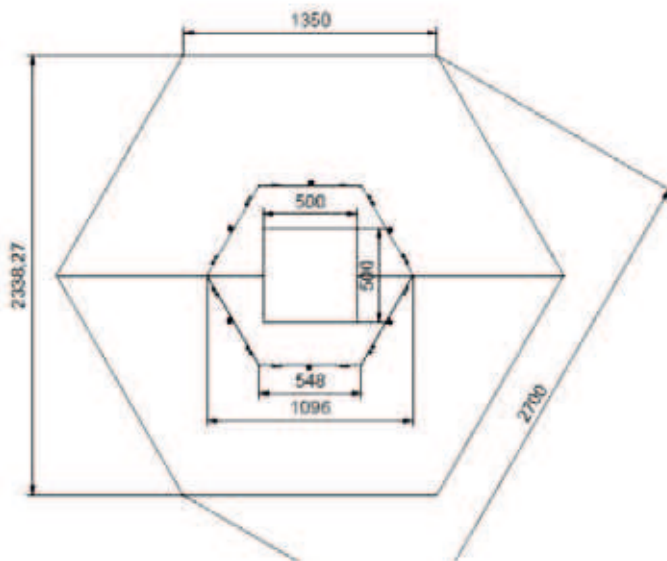

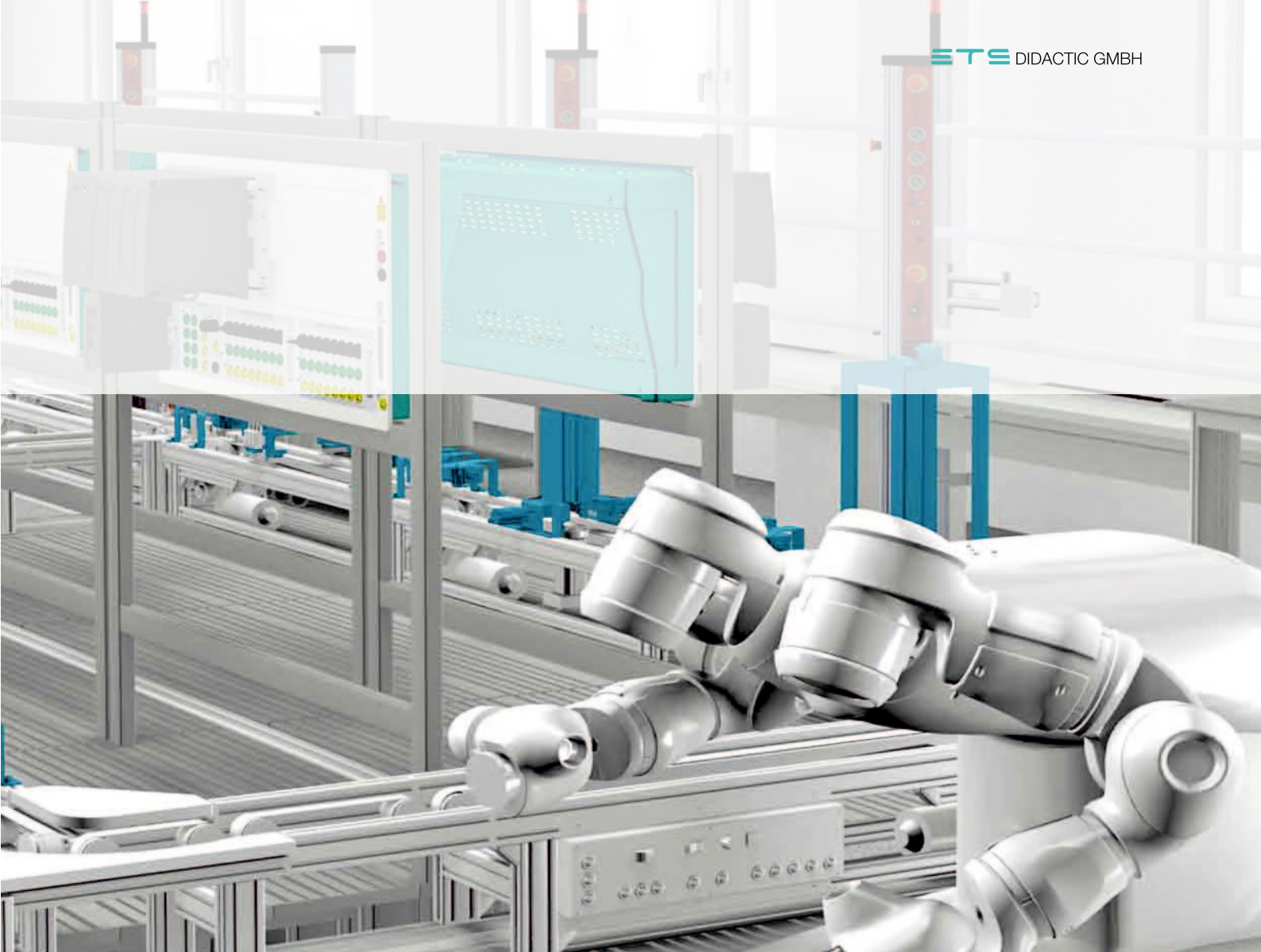

Design / Construction



Workshops



Application



PEOPLE AND TECHNOLOGY – A PERFECT MATCH

Didactic and Technology Result in the ETS-Concept

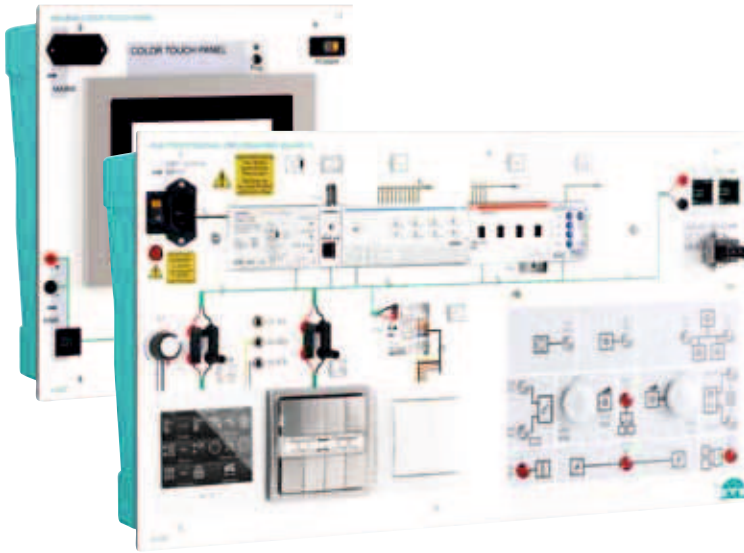

Compact Boards

- › Their didactical concept makes our training systems in A4 format outstanding.
- › The photorealistic design of their front panels with graphics, pictures, connection details or warning messages assist and guide the experiments - cognitive didactics. Due to the graphics, users comprehend and remember the technologies more easily.
- › The systems can be mounted in an A4 frame or placed directly on a table.

Experimental Boxes

- › Construct your own experiments. Beside the wiring, the arrangement of the components is focused. With the experimental boxes it's possible to practice basic circuits as well as complex installations
- › Always close to practice, fast and safe!
- › Wide range of industrial components.



BST®-BuildingSystemsTrainer

- › The BuildingSystemsTrainer® is a mobile training system that can be taken from one classroom to another and then is ready for use within some minutes.
- › Beside our laboratory equipment with the experimental boards, these flexible training systems represent an independent product line covering many topics as e.g. the VDE protective measures according to VDE 0100 or the KNX building communication sector, communications technology and renewable energies, SmartBuilding and internet-of-things.
- › Boards can also be integrated in the BuildingSystemsTrainer®

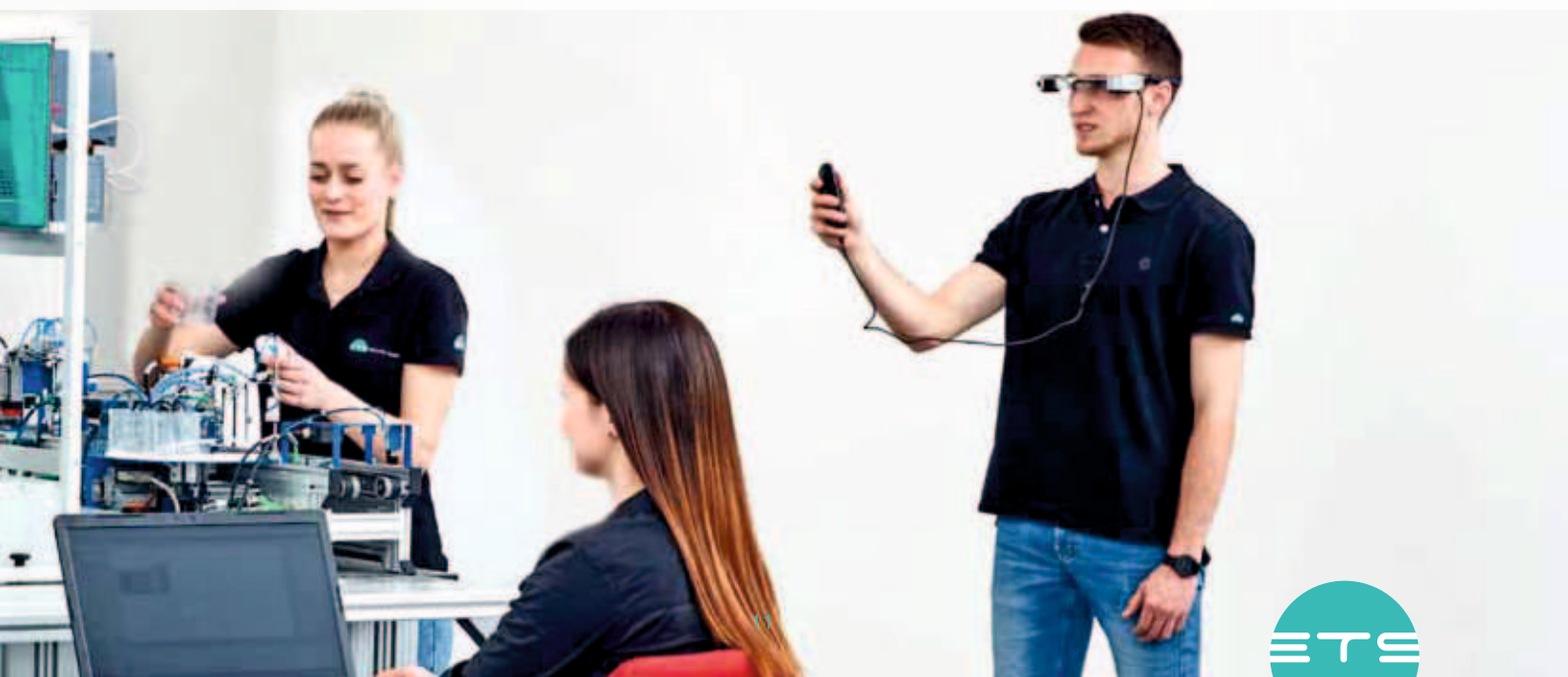

WORKSHOPS WITH ETS

Always up to Date – Training at the Highest Level



› Train the Trainer – workshops for teachers, trainers and lecturers in the field of electrical engineering, mechatronics and metal technology.

› Learn more about the management and the application of various technologies with the support of the ETS trainers. Find out more about the didactic concept and learn to teach the material quickly and safe.

› ETS offers a perfect seminar for all groups of products and topics of technical education. Scan the QR code to subscribe in a workshop:



ets-didactic.de/hp584/Workshops.htm



Fast and Safe into New Technologies

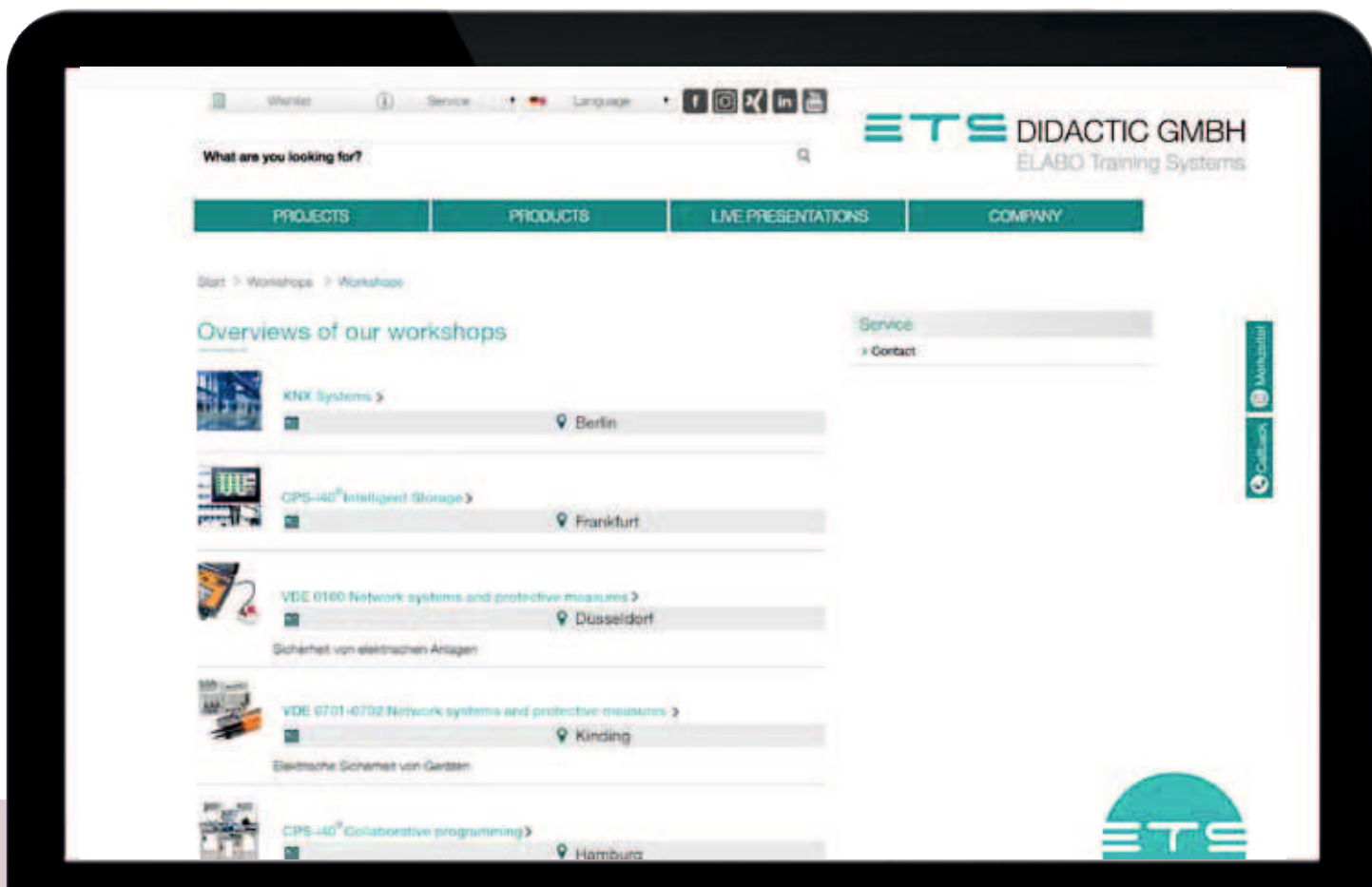

THE ETS TRAINING CONCEPT

Innovative Hardware / Perfect Courseware

Structure of the Manuals

- › Ringbinder principle
- › Dividers
- › Incorporation of personal documents

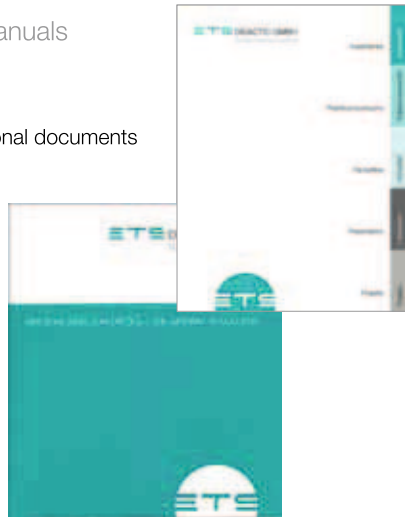

compact

TECHNOCards®

- › Depiction of the parameters in function groups
- › Start-up instructions
- › Safety functions
- › Individual learning help

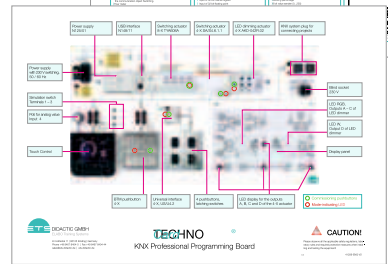
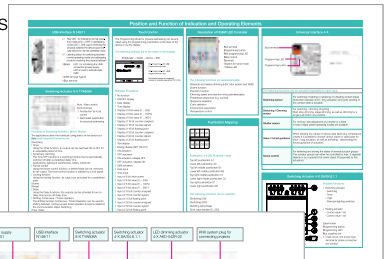

close to practice

Instructor's Edition / Student Edition

- › 100 % function guarantee
- › High print quality
- › Digital and on paper
- › Original photographs with practical references
- › Detailed work instructions



motivating

Simulations Software

- › Accompanying the courseware
- › Function simulation
- › Combination of theory and practice



multimedia

Front panel overlays

- › Contents reduced to main focus of the experiment
- › Clear layout
- › Basic function
- › Various languages



efficient

Furniture

- › Technically matched conception
- › Excellent functionality
- › Ergonomics at the workplace
- › Outstanding design



ergonomics

... the System for KNX Building Automation

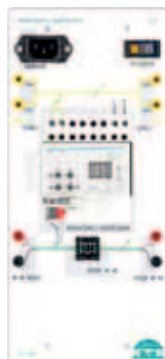
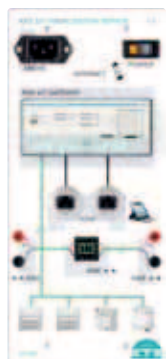
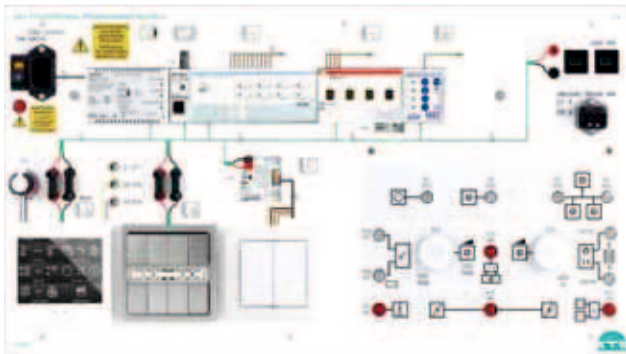

- › Latest technology
- › Easy to operate
- › Didactically prepared teachware
- › Safety for human and machine
- › Ergonomically perfect workstations



FROM ACUATOR TO ACCESS CONTROL

All at a Glance



KNX Weather Station



Project Dimming

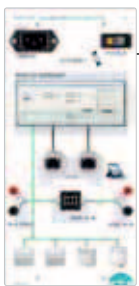

IoT Gateway



Access control

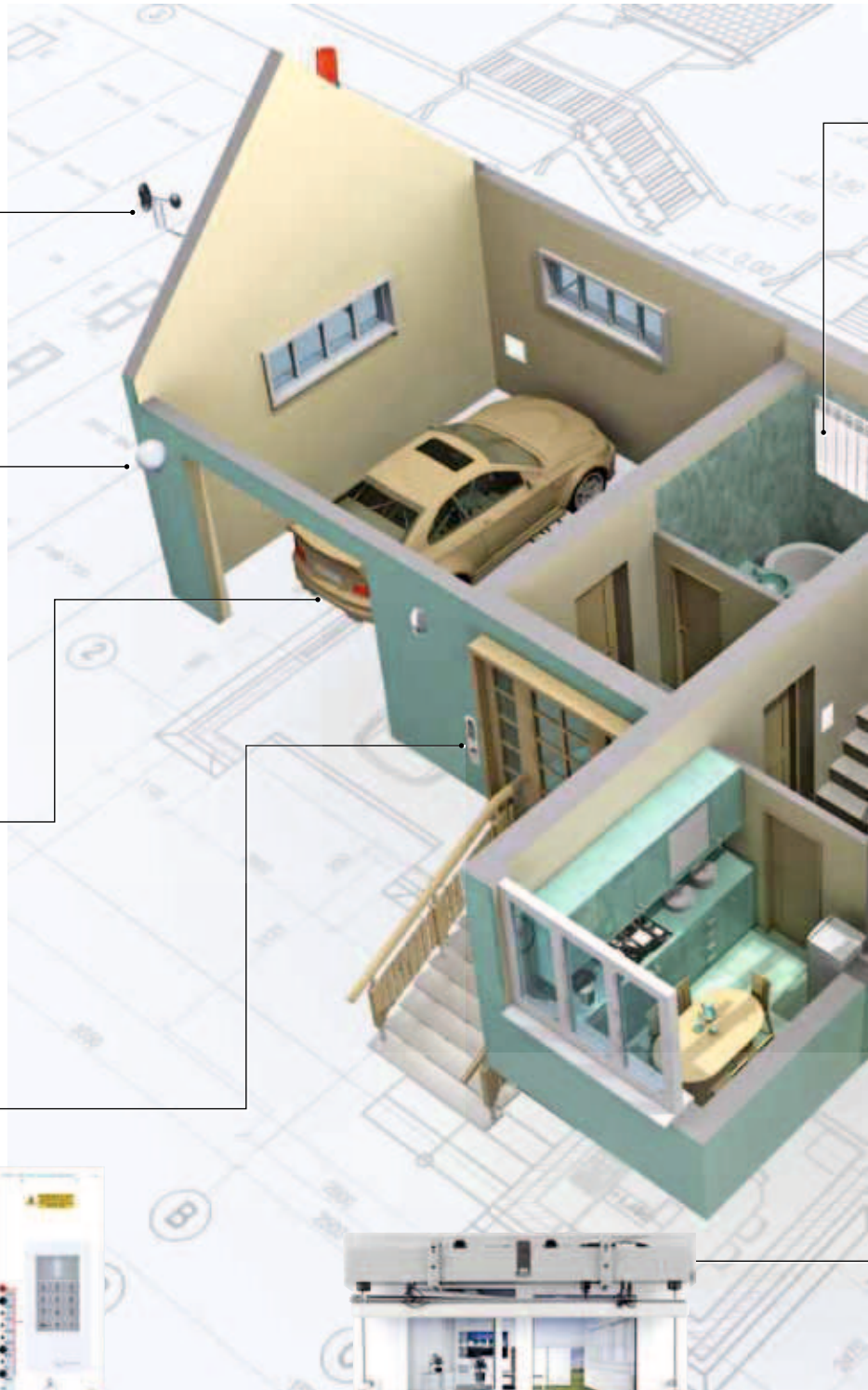

Technology model shutter



Project Heating Control

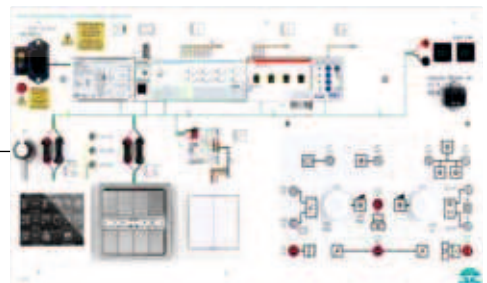

KNX Professional Programming Board II



KNX Color Touch Panel



PLC Board 230 V with KNX Extension Module

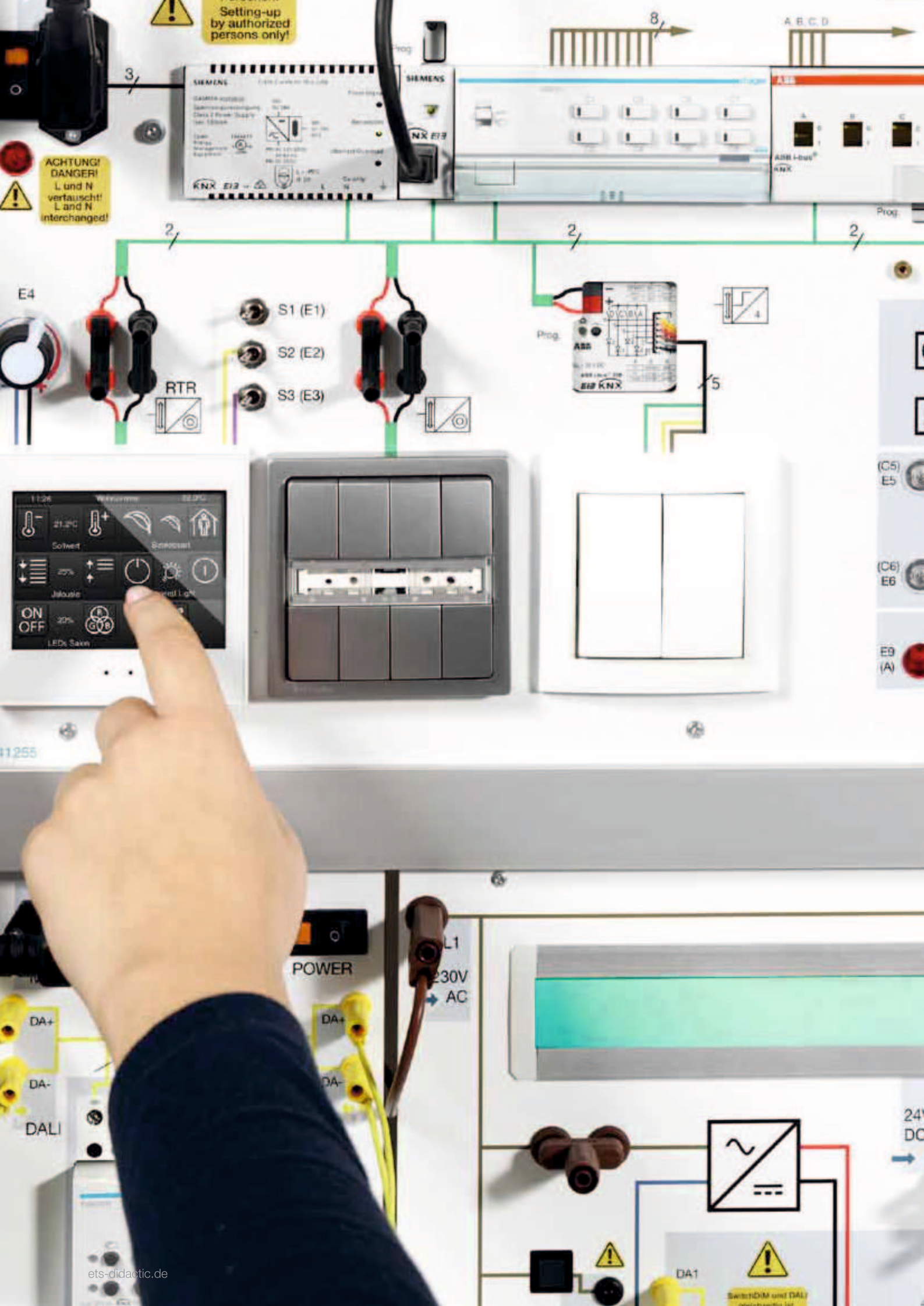

Setting-up by authorized persons only!

ACHTUNG! DANGER! L und N vertauscht! L and N interchanged!

E4

RTR

S1 (E1)
S2 (E2)
S3 (E3)

ABB KNX

(C5) E5
(C6) E6
E9 (A)

11255

POWER

L1
230V
AC

DALI

DA+

DA-

DA+

DA-

24V DC



DA1

SwitchDIM und DALI

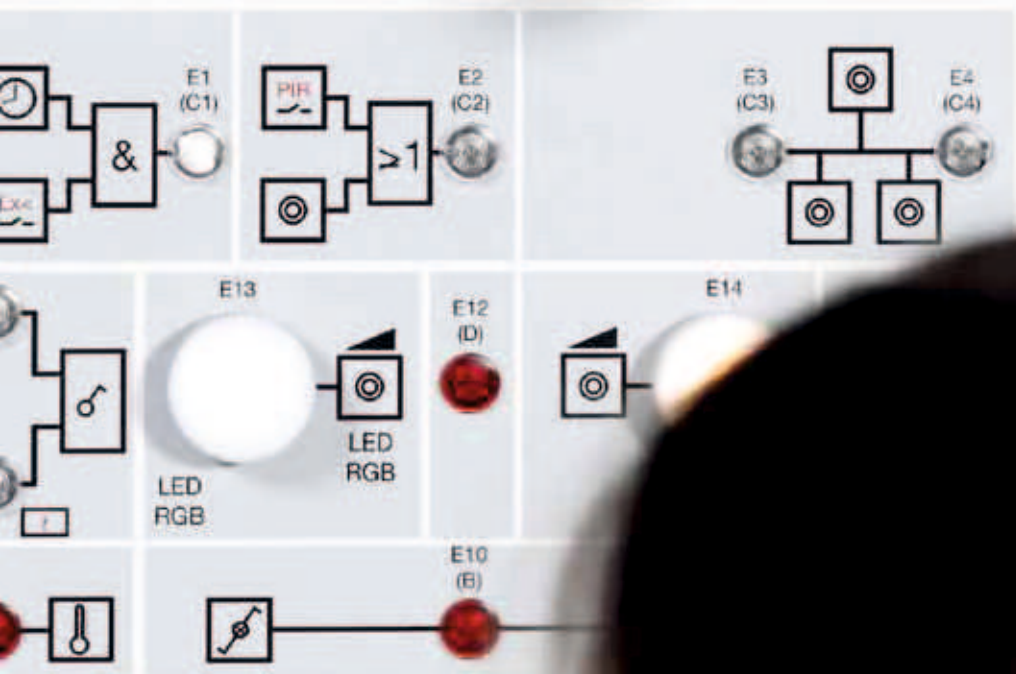
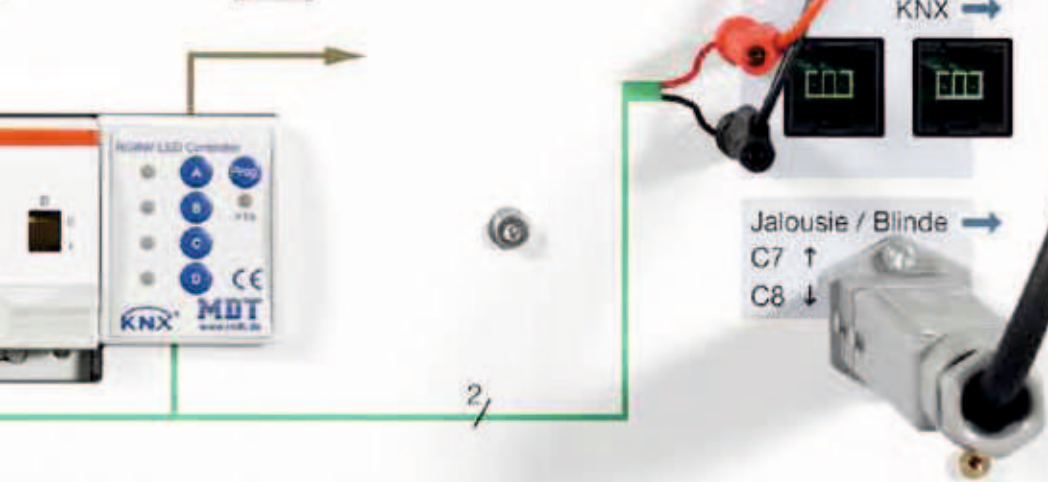

FUNDAMENTALS OF KNX

PROJECT PLANNING AND COMMISSIONING





Betriebsnahme
nur durch
autorisierte
Personen!
Setting-up
by authorized
persons only!

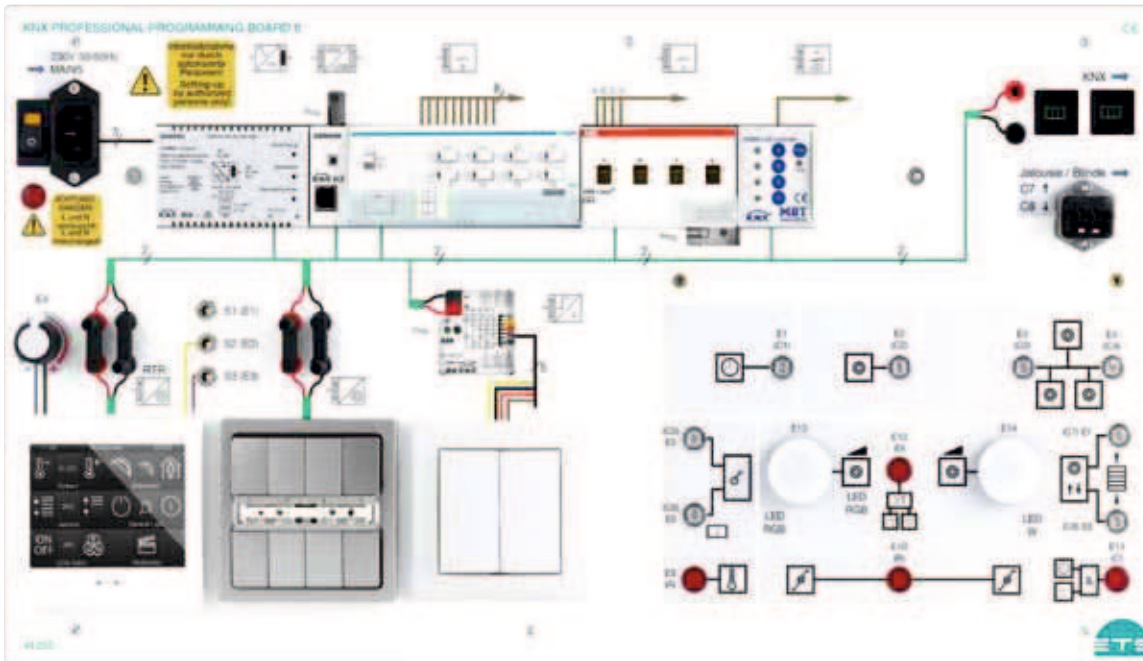

KNX PROFESSIONAL PROGRAMMING BOARD II

Configuring of KNX Systems



1

Learning Objectives

- › Configuring of KNX systems
- › Commissioning and troubleshooting
- › Documentation and maintenance

Technical data

- › Power supply
- › USB programming interface
- › Binary input 4-x with 4 simulation switches
- › 8-x switching-blind actuator
- › 4-x switching actuator with switching and heating functions
- › 4-x LED dimming actuator
- › 4-x multi-function pushbutton sensor with BTM
- › Touch screen control unit
- › 12 x indicator lamps
- › LED module white
- › LED module RGB
- › Sockets for onward connection to other KNX Boards



Various templates for exchange

No.	Designation	Order No.
1	KNX Professional Programming Board II	41255
2	Set of ET S ring binders	91905
3	Installation bus system KNX – Instructor's Manual	41264CD-ENG
4	Installation bus system KNX – Student Manual	41263CD-ENG
5	Installation bus system KNX – Presentation Aids	41265CD-ENG
6	TECHNOCard® – KNX Professional Programming Board	41266-ENG
7	Template / Application principle Circuit-breaking	41251
8	Template / Application principle Heating Control	41252
9	Template / Application Office building	41253
10	Template / Application Residential Building	41254

Courseware



2

Printed and digital

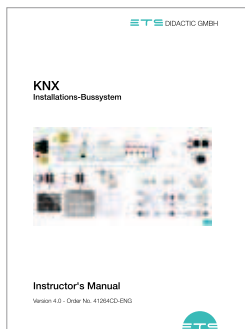

3

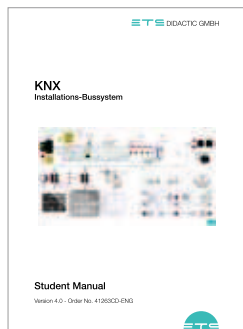

4

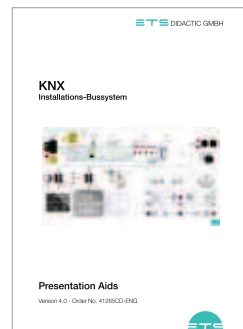

5

Manual

› Fundamentals

› 11 experiments on the basic building function: switch off, change-switch, push button switch, central off, dim lighting, blind control, time control, logic function AND, logic function OR, heating control and RGB color control.

› Project:

- Project 1:

Circuit-breaking, pushbutton circuit, dimming, blind function and-room temperature control

- Project 2:

Timer function extension

- Project 3:

Office building with safety function for blind and logic function AND

TECHNOCard®

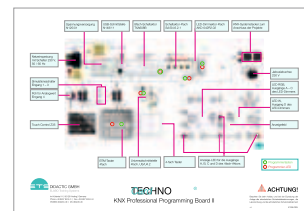

6

KNX-Applications

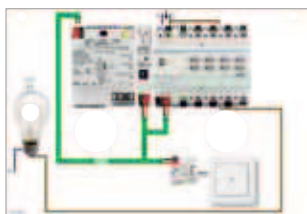

7

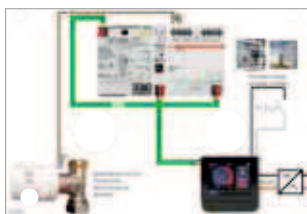

8



9



10

Templates (Applications)

for simulation of room constellations in indoor and outdoor areas of various buildings

› Principle: Circuit-breaking

› Principle: Heating Control

› Office building

› Residential Building

KNX PROFESSIONAL PROGRAMMING BOARD II

System Overview

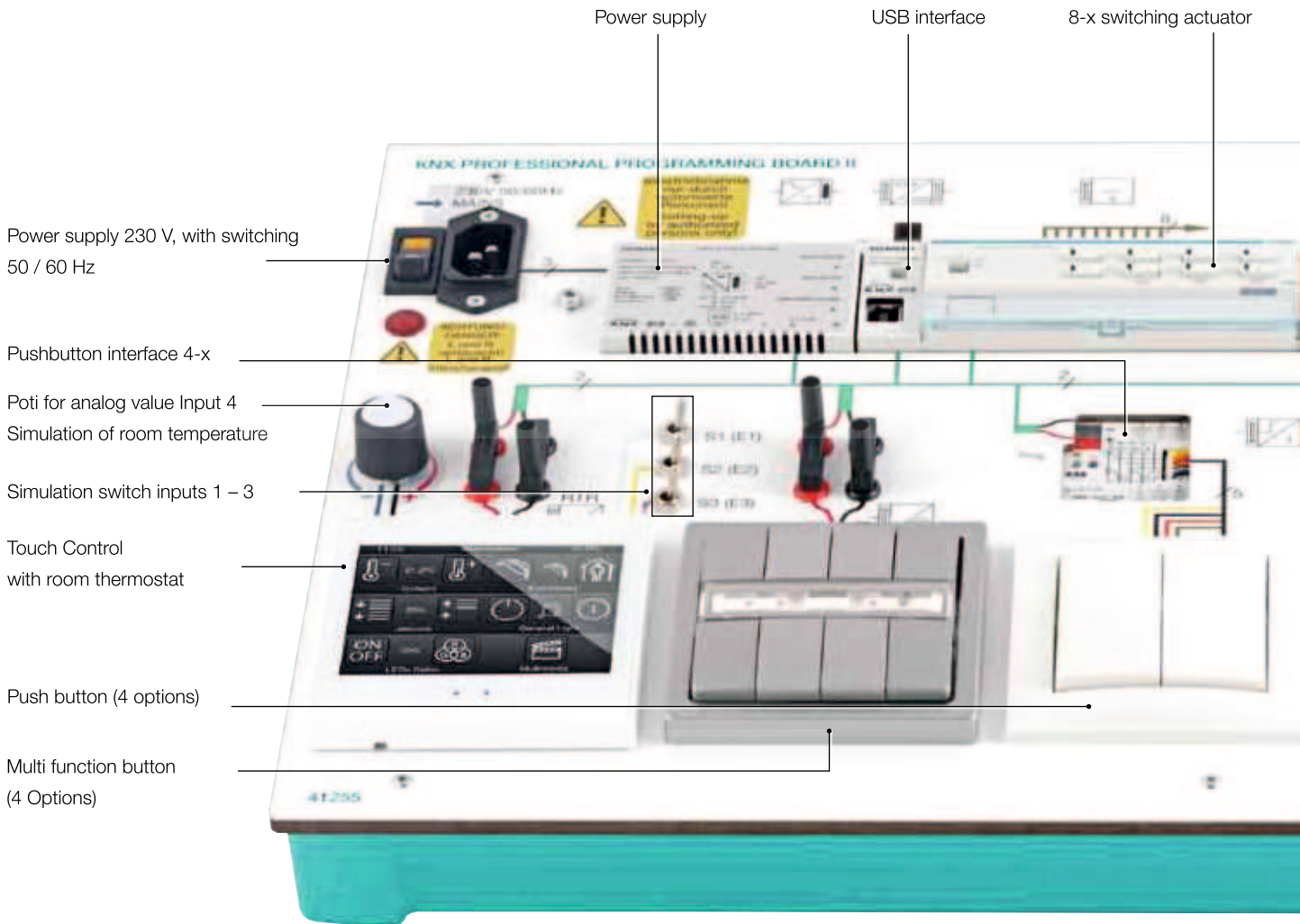

Templates for Exchange

- › Principle: Circuit-breaking
- › Principle: Heating control
- › Office Building
- › Residential Building

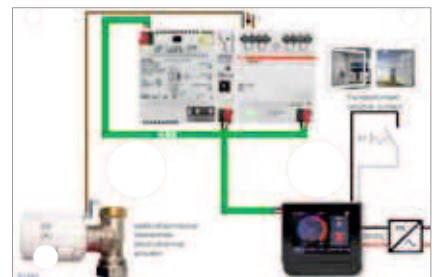
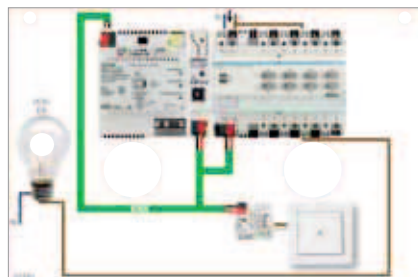

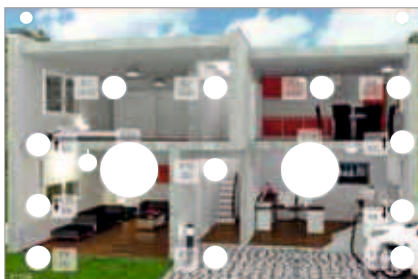
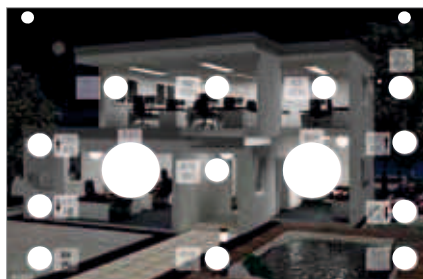
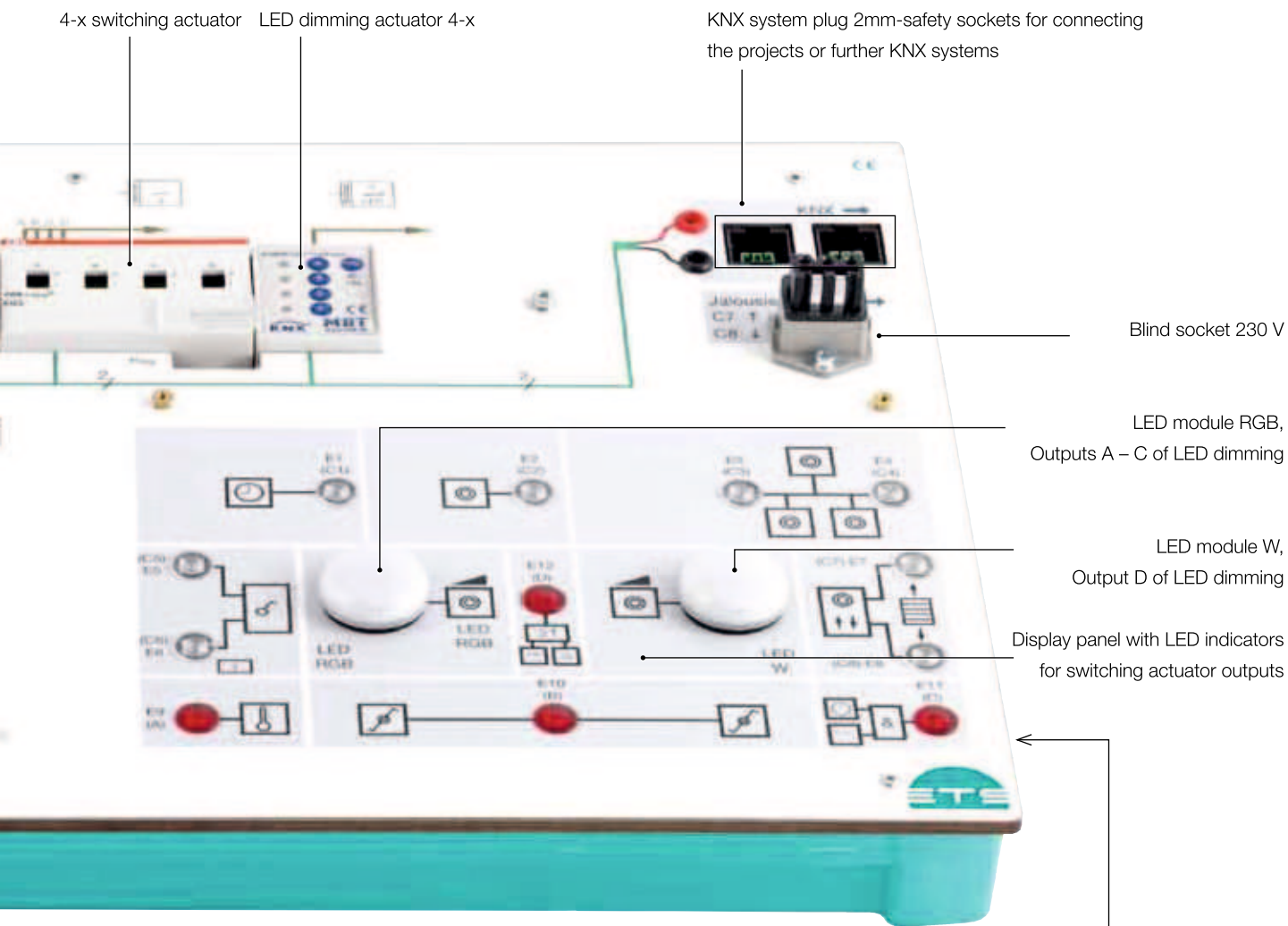

SOFTWARE

KNX Programming Environment



1

Learning objectives

- › Configuration of KNX systems
- › Commissioning and troubleshooting
- › Documentation

Technical data

- Configuration and commissioning of intelligent building automation solutions in residential and functional buildings
- › Resetting and restoring functions
- › Full drag & drop functionality
- › Editing feature within the working window
- › Clear parameter display
- › Bus connection via USB interface, network or internet
- › Reports for project documentation

No.	Designation	Order No.
1	KNX programming environment ET S 5 Lite	90144
2	KNX programming environment ET S 5 Trainer package	90146
3	KNX Professional Connection Line	41002
4	USB Programming Connection Line	80544

ETS5 Lite and ETS5 Trainer Package

KNX programming environment

) For planning and configuration of intelligent KNX home and building control. The ETS5 supports the realisation of home and building control projects in the following phases:

1. Configuration
2. Commissioning
3. Project documentation
4. Diagnosis and troubleshooting

ETS5 Lite

Full software version with bus access, pressure function, without time limitation for: max. 20 products; 1 line (no export function)

) Single licence with Dongle

ETS5 Trainer Package

consisting of:

-) 1 x ETS 5 Professional
-) 10 x ETS 5 Lite

System requirements

) Operating system

Microsoft Windows 8.1 x32/x64

Microsoft Windows 10 x32/x64

) Hardware

CPU: ≥ 2 GHz

RAM: ≥ 2 GB

HDD: ≥ 20 GB

Resolution: $\geq 1024 \times 768$



1 / 2

Accessories



3



4

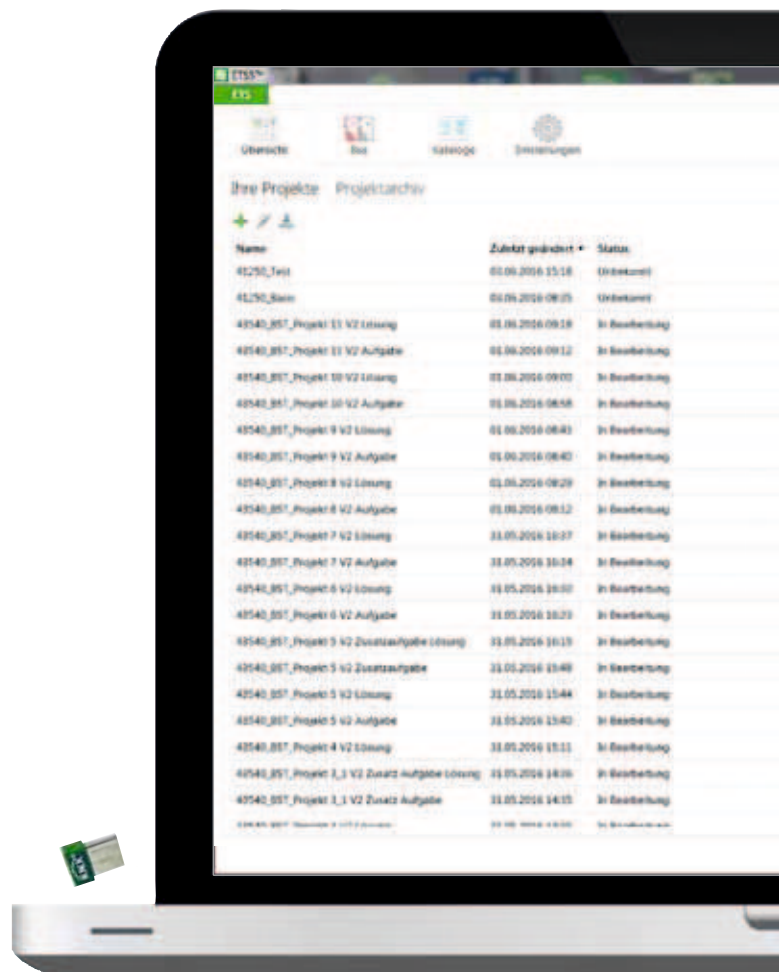

KNX HEATING CONTROL

Cooling and Heating with KNX

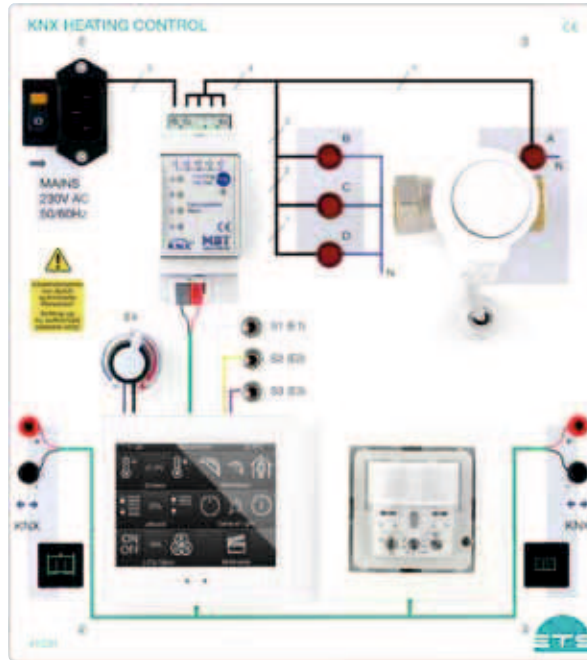

1

Learning objectives

- › Move to correcting variable, position and forced position
- › Test heating and cooling function
- › Parameterize comfort mode and night setback
- › Testing frost and heat protection and standby operation
- › Commissioning and troubleshooting
- › Parameterize 2-point control
- › Parameterize continuous control
- › Parameterize integrated controllers

Technical data

- › 1 Electrothermal actuator for 2-point or PWM control
- › 3 Simulation switch
- › KNX motion detector with integrated temperature sensor
- › Touch room controller with integrated thermostats
- › KNX heating actuator with integrated controller

TECHNOCard®

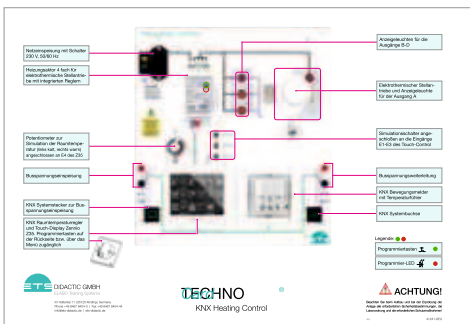

Further Course-ware to the product see page 75

2

No.	Designation	Order No.
1	KNX Heating Control	41031
2	TECHNOCard® KNX Heating Control	41241

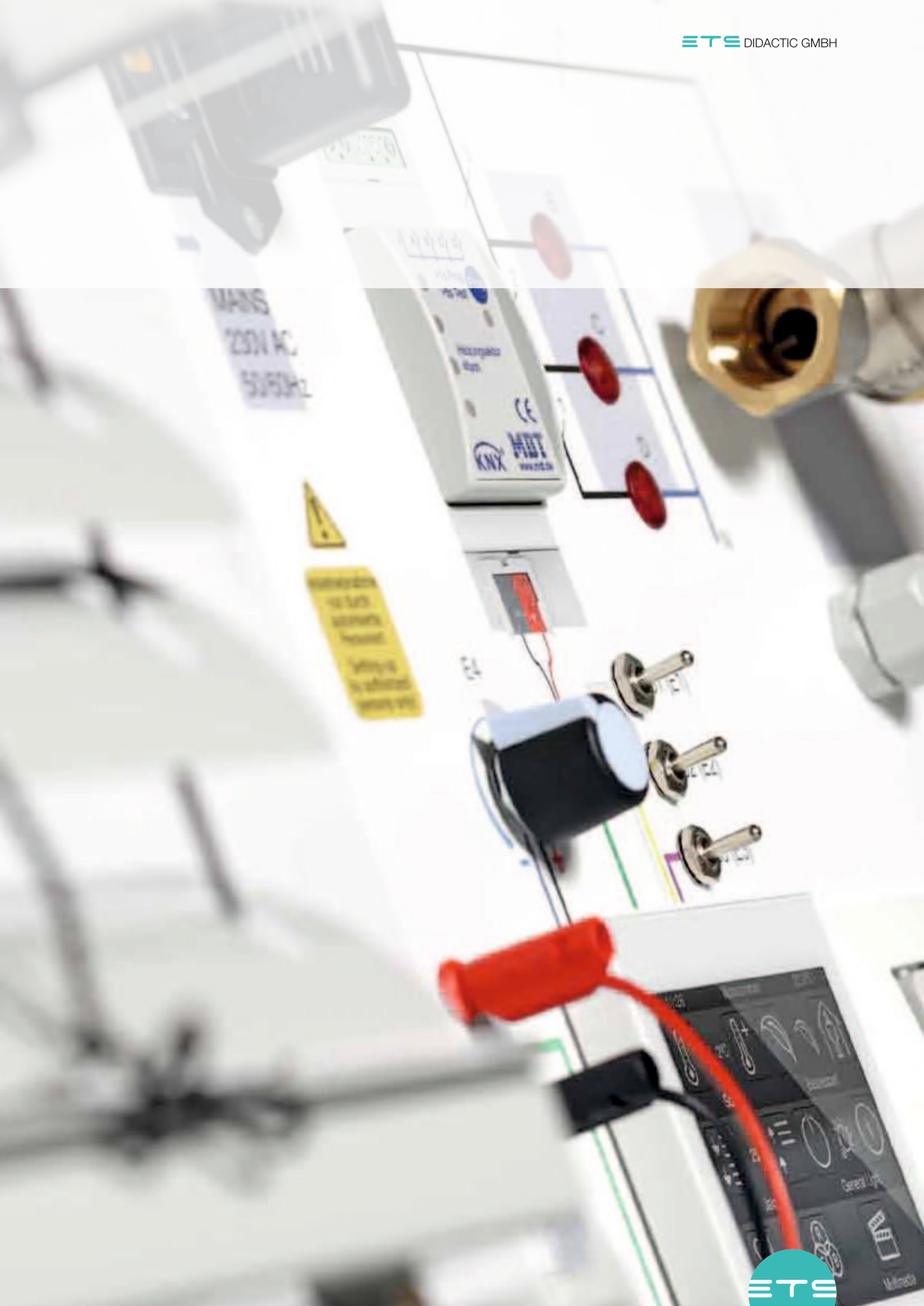

VISUALIZATION

KNX IoT Visualization Server

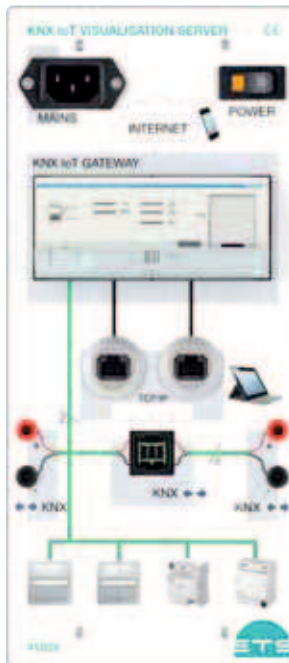

1

Learning objectives

- › Clearly display the operation states of the consumers in a building on a Windows PC, tablet or a smartphone (Android or iOS)
- › Central monitoring and operation of components
- › Create visualization pages
- › Visualization of states or object values
- › Creation of operating pages
- › KNX coupling to IoT
- › External system integrated

The visualization server offers following possibilities

- › Operating the KNX system
- › Observing the KNX installation
- › Alarm handling
- › E-Mail notification
- › Monitoring (e.g. via webcam)
- › Data archives
- › Calendar program
- › Use of own images
- › Full touchscreen support

Technical data

- › KNX connection
- › Network connection
- › Internal power supply unit
- › USB connection
- › Mains voltage connection

No.	Designation	Order No.
1	KNX IoT Visualization Server (Parameterization software included)	41029
2	Communication Center (see page 30)	41057
3	KNX Professional Programming Board (see page 30)	41255
4	Bulb Socket Board (see page 30)	43126
5	ZIG BEE Gateway Board (see page 30)	41026

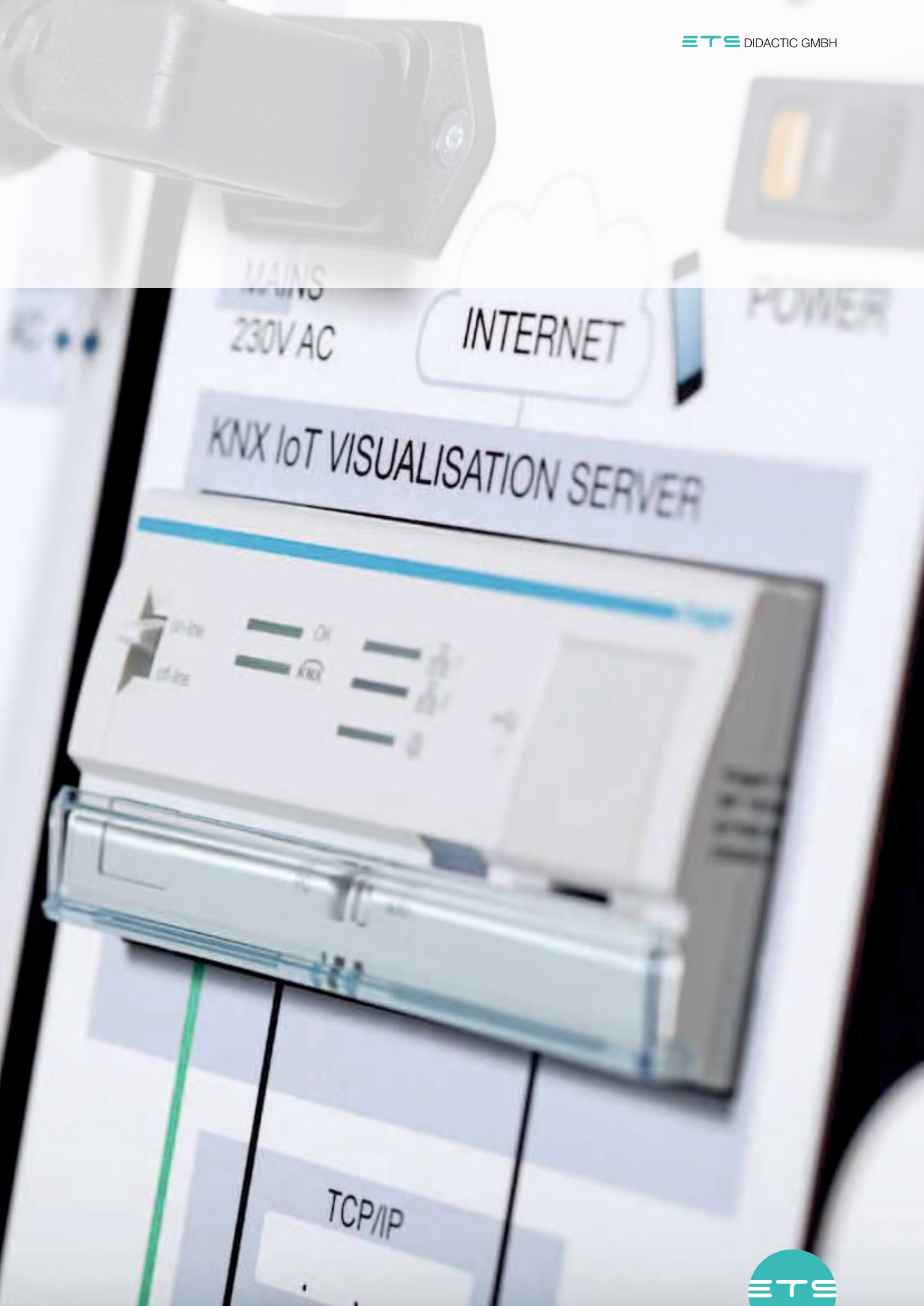

MAINS
230V AC

INTERNET

POWER

KNX IoT VISUALISATION SERVER

in-Net
out-Net

DI
KNX

DI
DI
DI

TCP/IP

VISUALIZATION

KNX Visualization Server

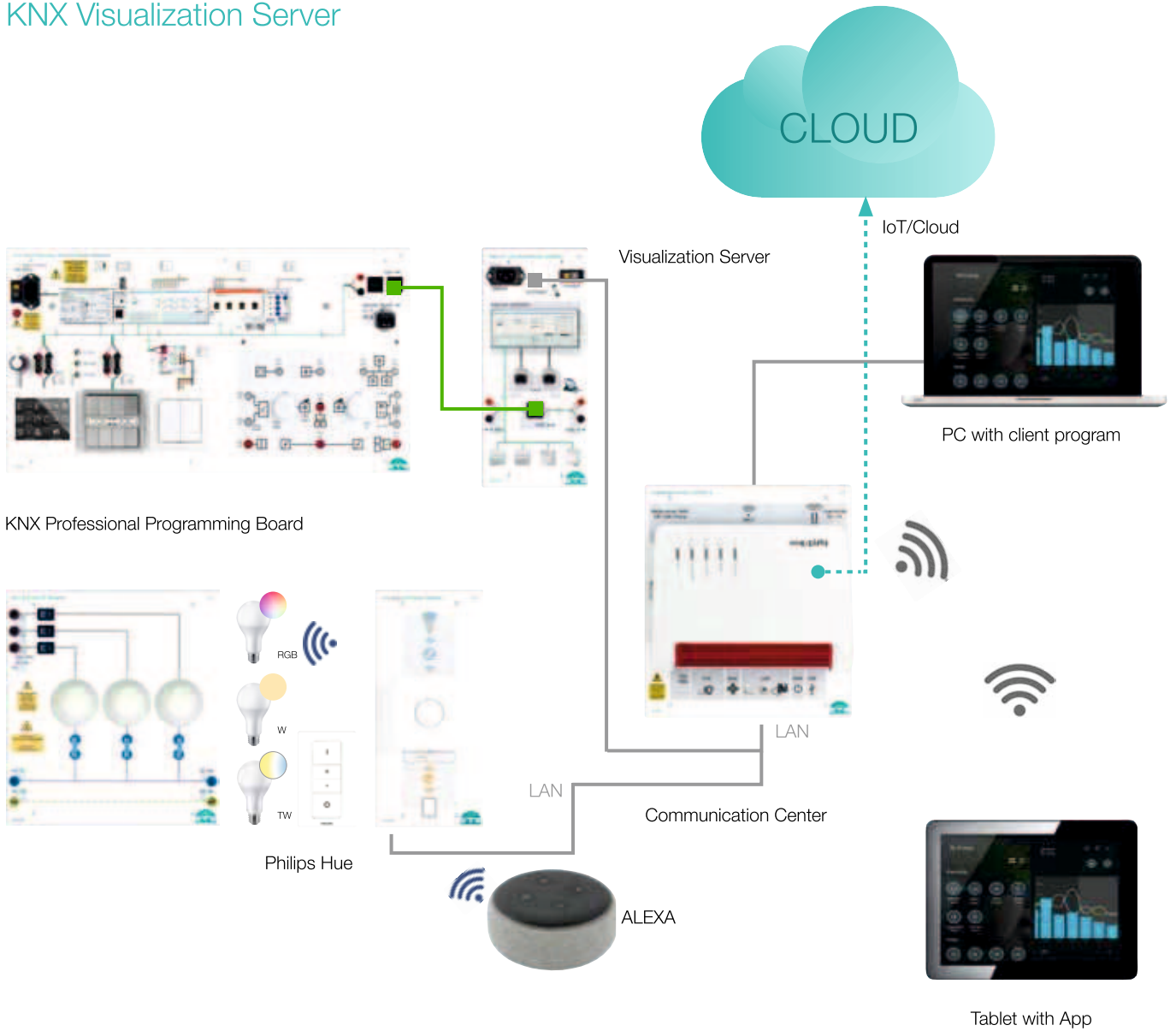

Visualization and Control via App

iOS or Android





KNX TOUCH PANEL

Control and visualization of KNX installations



1

Learning objectives

- › Control and visualization of KNX installations
- › Switching
- › Switching/dimming with stop telegram
- › Switching with forced guidance
- › Blind control
- › Set values 1 byte
- › Set temperature value
- › Set counter value
- › Recall/Save Scenes
- › Setting the heating operating mode
- › Status display 1 bit
- › Status display 1 Byte
- › Status display 2 Byte
- › Status display 4 Byte
- › Screensaver
- › Time and logic functions
- › Presence simulation

Technical data

- The board contains the following components:
- › KNX Color Touchpanel 5.7" color TFT
 - 10 operating pages with 5 functions each
 - up to 60 additional functions can be realized
 - up to 64 scenes can be stored
 - there are 16 alarm/event objects available
 - › Main and bus voltage connections

No.	Designation	Order No.
1	KNX Colour Touch Panel	41227

Examples of display pages on the Touch Panel

Conference 1	Office 1
Conference 2	Office 2
Meeting 1	Reception
Meeting 2	Kitchen
Lobby	Hall

10:42AM
03/05/10

Home	Configuration
General	
Scenes	
Logic	
Presence	
Schedules	
Curves	

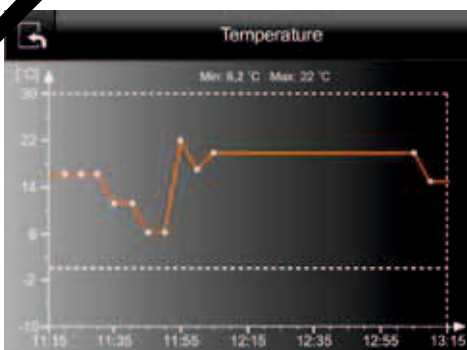

- › Operating and status pages
- › Configuration pages
- › Trend modules
- › Logic, scenes and presence simulation



KNX UNIVERSAL SENSOR BOARD

Installation and connection of KNX sensor technology

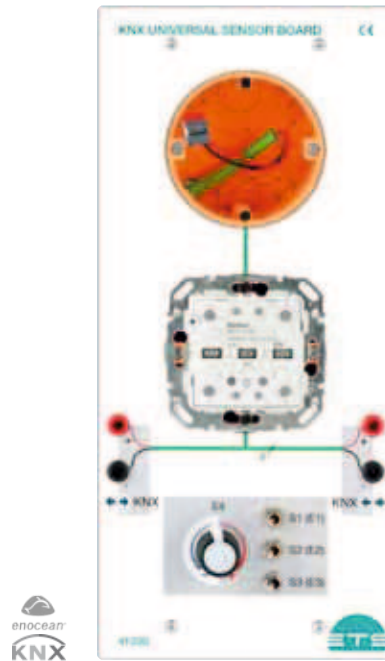

1

Learning objectives

- › Installation and connection of KNX sensors
- › Integration of further sensors
- › Select sensors for specific projects

Technical data

- › 2 mounting boxes for sensors
- › Potentiometer
- › 3 Push-button switch

No.	Designation	Order No.
1	KNX Universal Sensor Board	41030 XX*

* See page 35

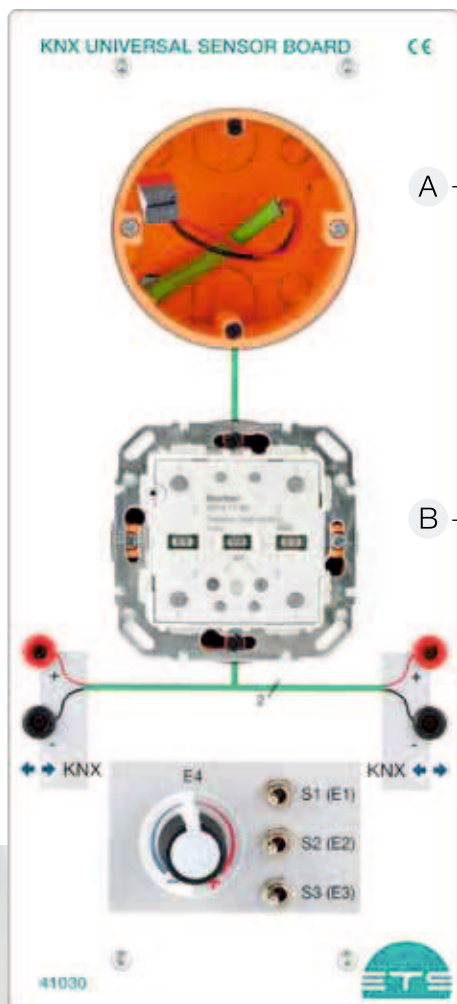

- a) Touch control
- b) Motion detector
- c) Room temperature
- d) Presence detector
- e) Enocean sensor
- f) Enocean interface
- g) KNX wireless sensor
- h) KNX radio gateway

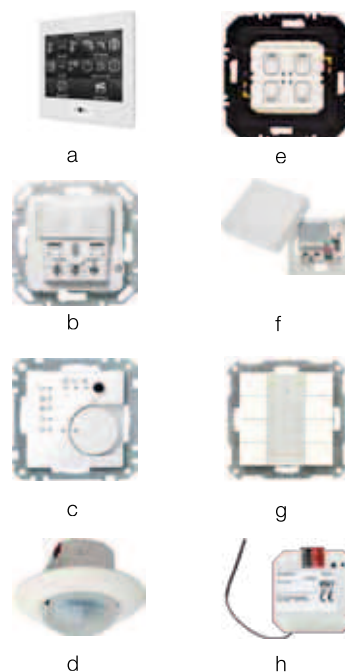

- a) Touch control
- b) Motion detector
- c) Room temperature
- d) Presence detector
- e) Enocean sensor
- f) Enocean interface
- g) KNX wireless sensor
- h) KNX radio gateway

Example Order no.

Order No.

41030 a d — Pos B

Pos A

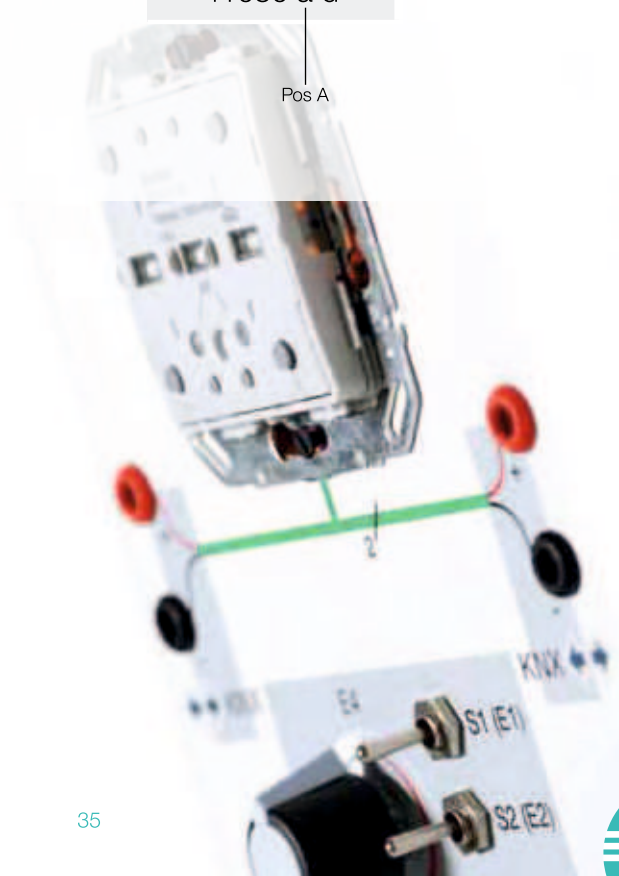



max
AC/5A

Inbetriebnahme
nur durch
autorisierte
Personen!
by authorized
persons only!

Achtung! Spannung!
Attention! Risk of burns

→ N



SMART LIGHTING

INTELLIGENT BUILDING CONTROL

SMART HOME LIGHTING SET

Intelligent lighting control



1

The Smart Home lighting set

consists of intelligent LED lamps. The set shows what is possible and will be possible in the future with digitalization of light. By means of iOS or Android devices, the illuminates can be controlled and designed. For example, you can create a multi-colored room ambience, create light recipes for relaxation, concentration, reading or vitalization and let yourself be woken up in the morning by a sunrise timer. The system can also be linked to other devices and applications.

Learning objectives

- › Commissioning of smart light sources
- › Integration into external systems
- › Color and scene control
- › Networking of the illuminants and controls
- › Set up network participants

Technical data

Consisting of:

- › Lan ZigBee Bridge on board
- › LED illuminant white (E27)
- › LED illuminant turnable white (E27)
- › LED illuminant RGB (E27)
- › Power supply for Bridge

No.	Designation	Order No.
1	Smart Home Lighting set	41026
2	Bulb Socket Board	43126

BULB SOCKET BOARD

Optional accessories

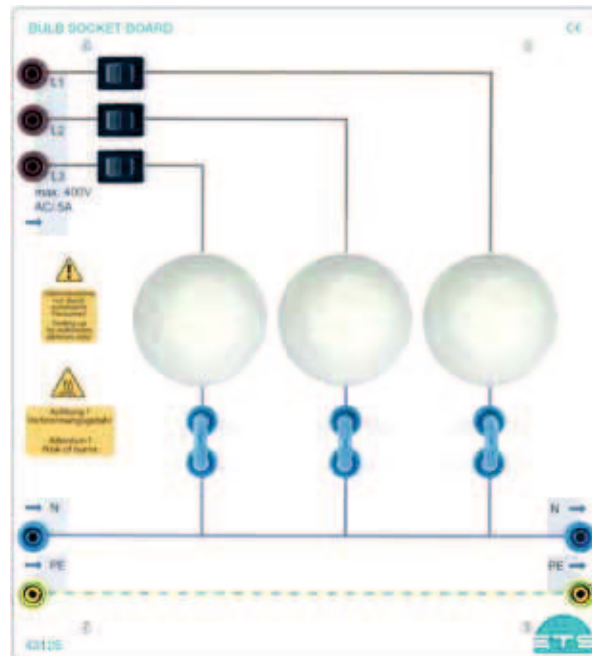

2

Technical data

Consisting of:

- › Three consumer sockets (E27)
- › Power supply via 4mm safety sockets, for each consumer individually
- › 3 ON/OFF switch
- › Operating voltage/frequency: 230V; 50Hz





WEATHER

WEATHER SENSITIVE BUILDING CONTROL

SPRING SENSOR TECHNOLOGY

KNX Weather Station



1

Learning objectives

- › Collection and evaluation of weather data
- › Temperature monitoring
- › Evaluation of brightness e.g. for constant light control
- › Brightness dependent control of the lighting
- › Wind monitoring e.g. for the control of blinds
- › Time recording via DCF 77 and forwarding to the bus
- › Logical interconnection of signals
- › Facade control of blinds or roller shutters
- › Evaluation of rain alarm

Functions

Universal KNX module "Weather Station" with the following functions:

- › Rain sensor
- › Wind sensor
- › Temperature sensor
- › DCF 77 receiver
- › Light sensor
- › Facade control
- › Logic function/timer
- › Different limit values can be set for each function

No.	Designation	Order No.
1	KNX Weather Station	41022

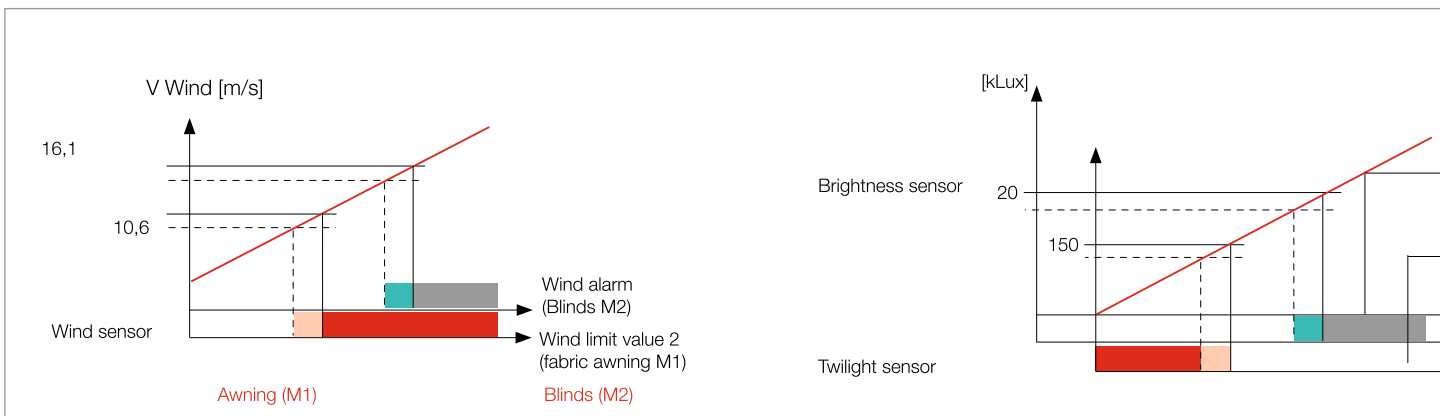

Evaluation of the different sensors

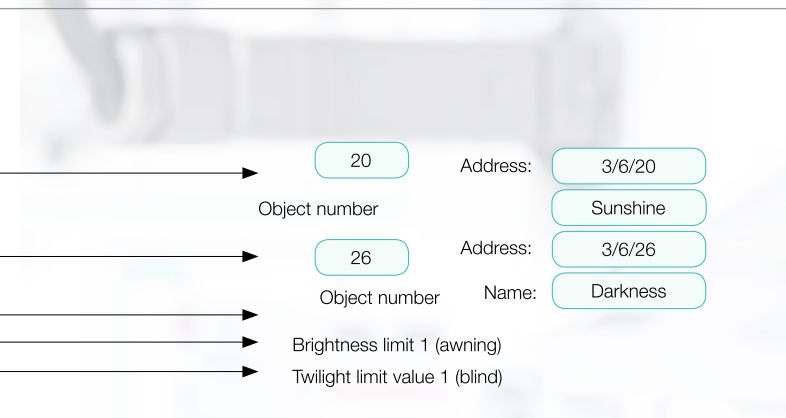
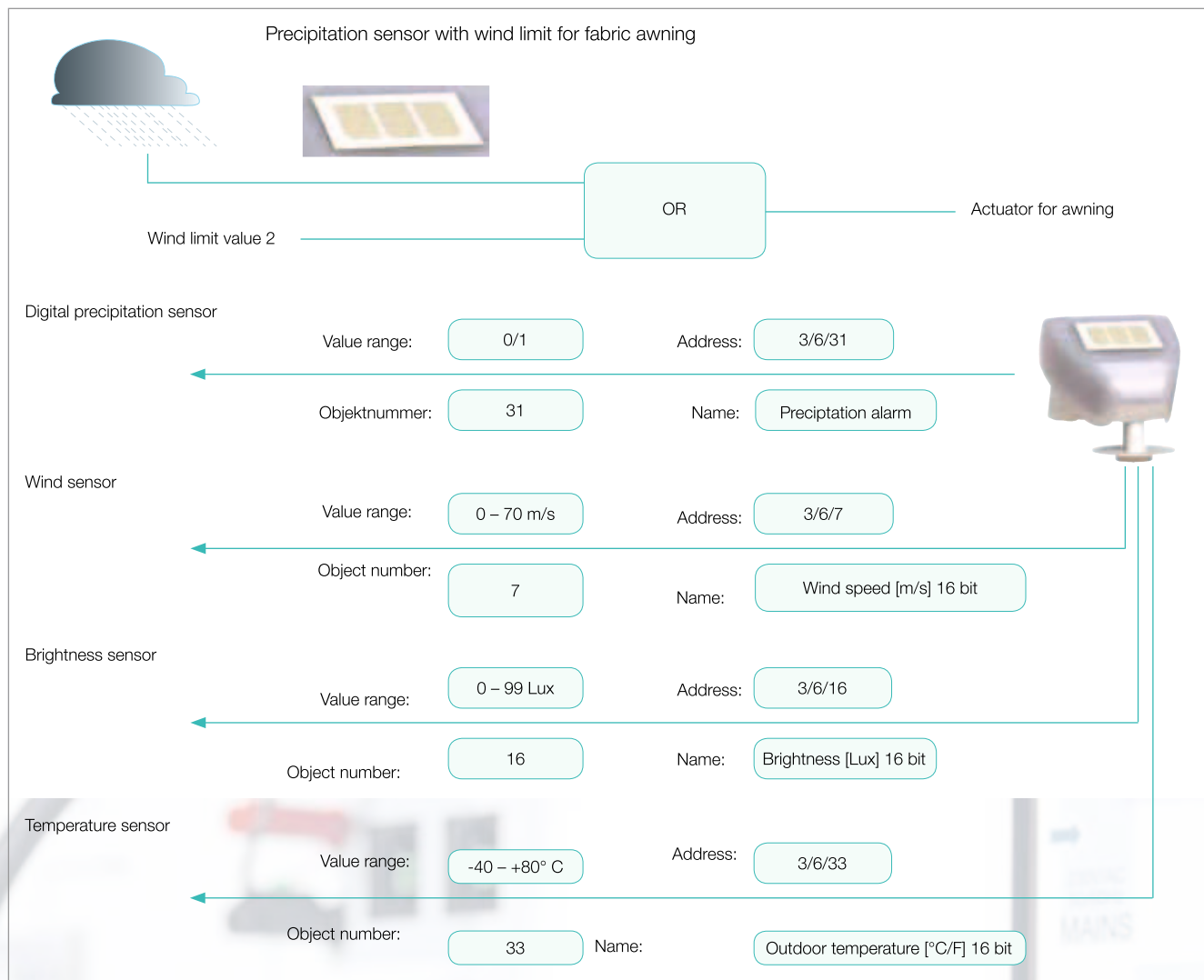

SUN PROTECTION

Blinds Board



1

Technology Model KNX Blinds

Experimental board in DIN A4 teaching board format. Blind mounted on a board for use in the experimental frame. The connection is made to a standard 230V blind or shutter actuator.

To teach the functions:

- › Blind drive
- › Slat adjustment
- › Positioning
- › Security

Technical data

- › Operating voltage 230 V AC 50Hz
- › Connection to blind socket with connection cable approx. 1 m
- › Dimensions l x h x w:
532 x 297 x 120 mm

Execution

Board with photorealistic, four-color front panel design. Colored line display according to color code. The board surface is scratch-resistant due to special coating. Didactic standard marking with operating instructions and connection options make commissioning easier for the user.

No.	Designation	Order No.
1	Blinds Board	41117
2	KNX Professional Programming Board II	41255
3	KNX Weather Station	41022
4	KNX Colour Touch Panel	41227

Weather-dependent blind control

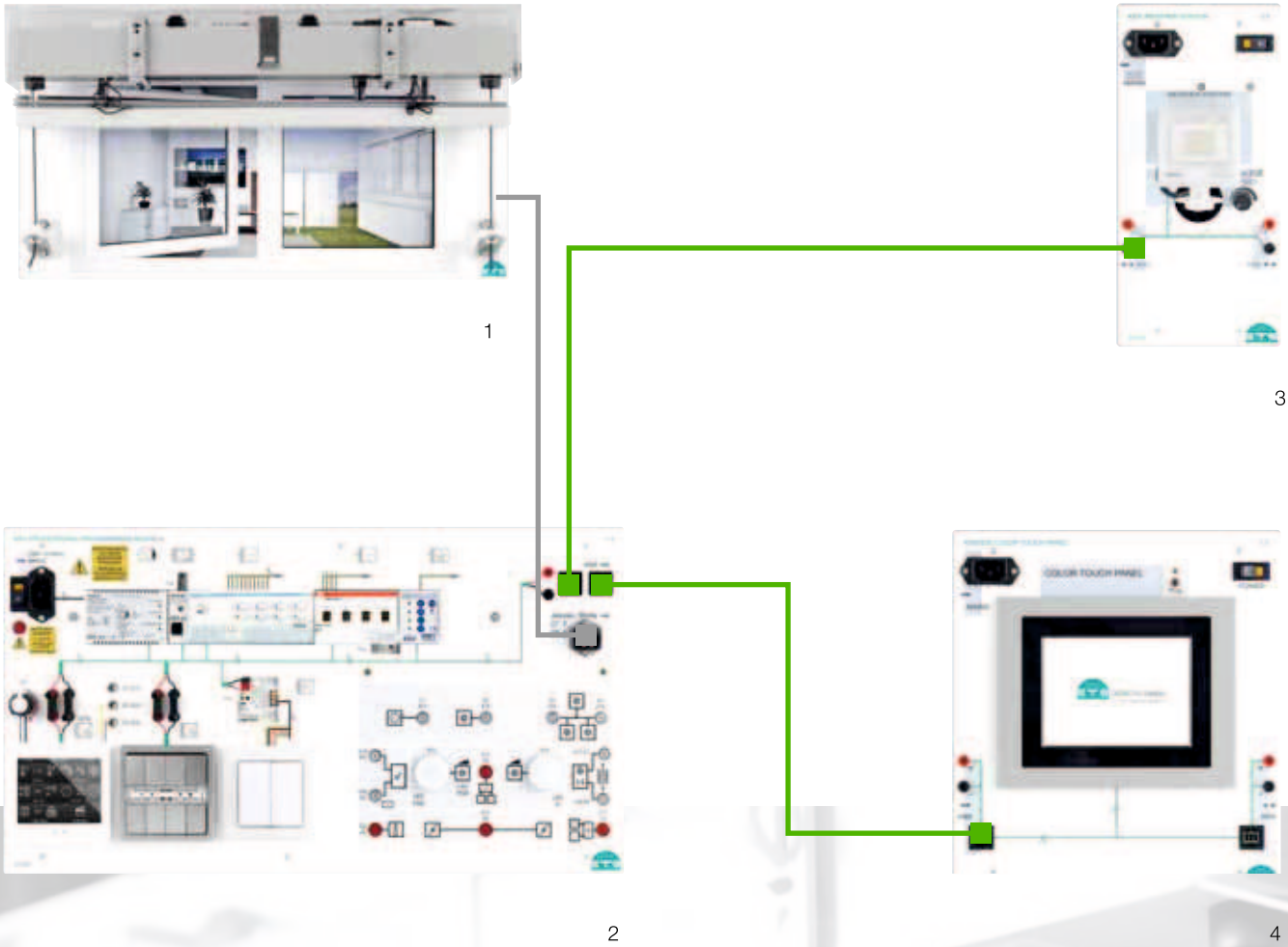

FROM INSTALLATION TECHNOLOGY...

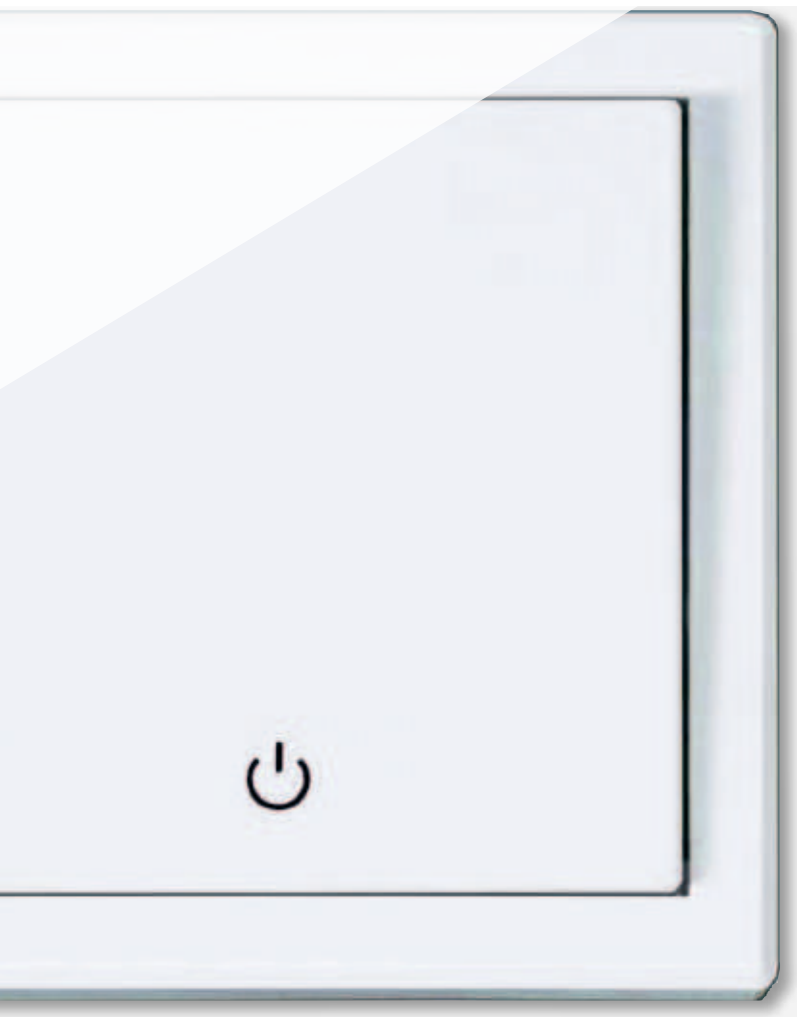

...TO NETWORKED BUILDING CONTROL



Installation Technology

Installation Switch Board I

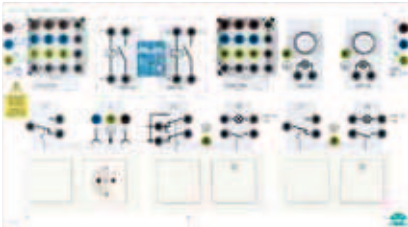

Intercom Main System



Intercom Sub System



Set of house intercom and signal systems consisting of:
1 x outdoor station and 2 x indoor station

Intercom system in bus technology

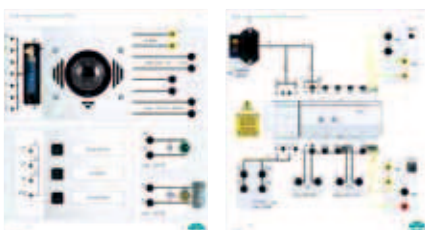

Network installation set



LWL connector assembly tool set

IP-based communication

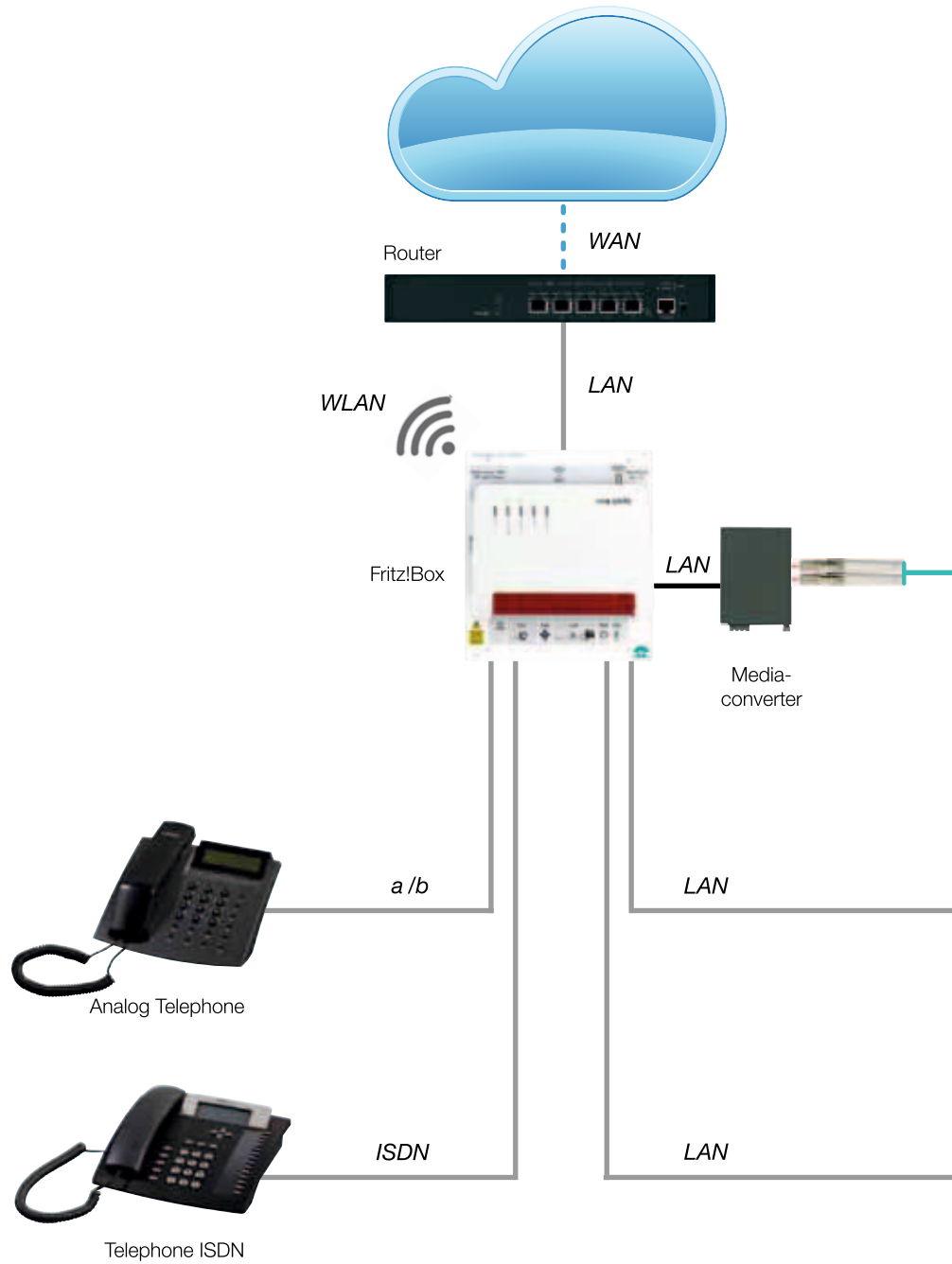



Smartphone / Tablet
Video Client



Telephone SIP
WLAN

FITH

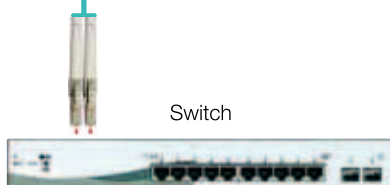

Switch



Telephone SIP



PC

PoE



Patch Panel Board



Video Telephone SIP

KNX

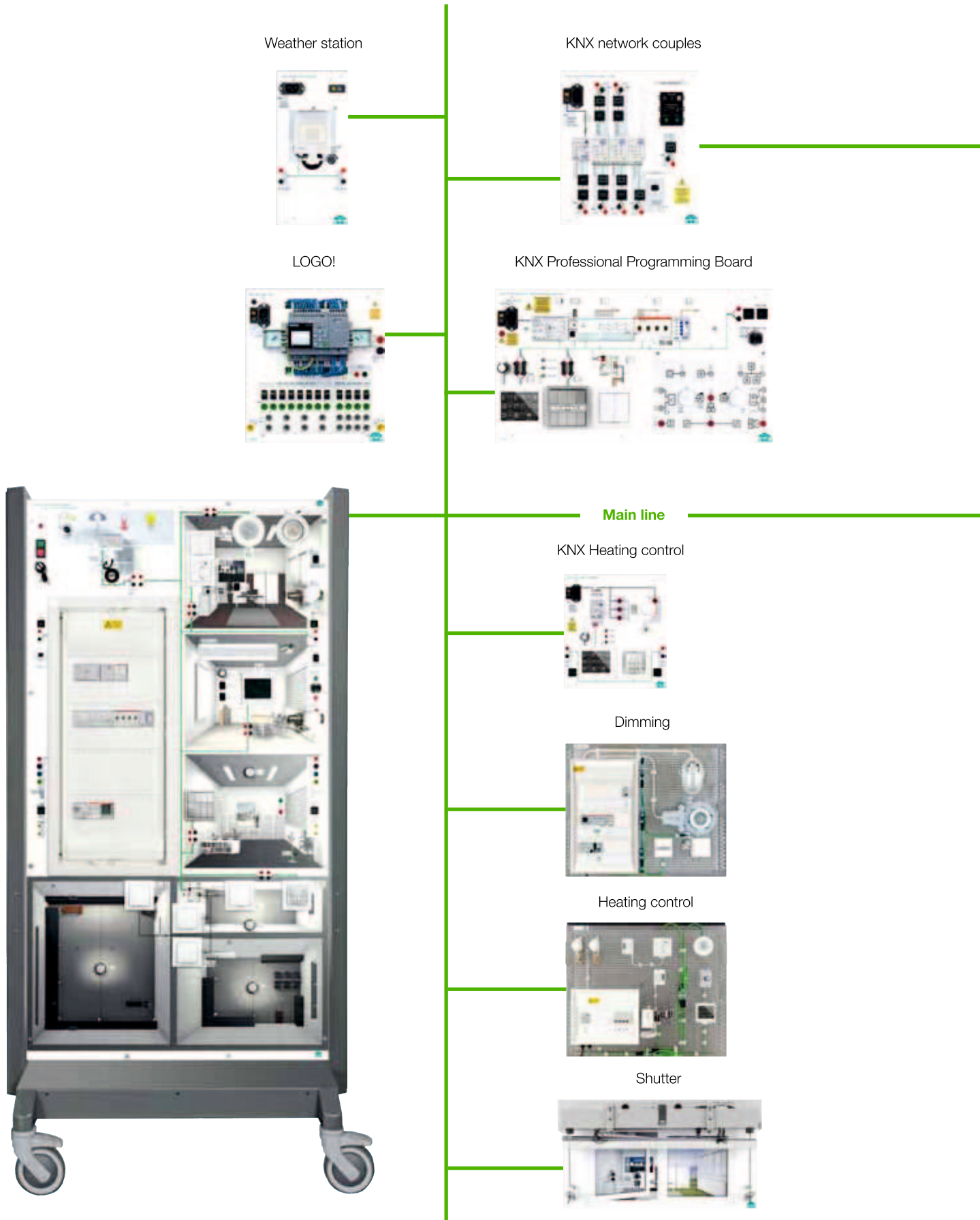

Lighting Technology / DALI

1. Line

KNX Programming Board



Fluorescent lamps Board A and B

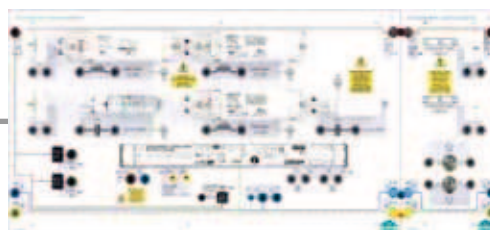

DALI Gateway -V2

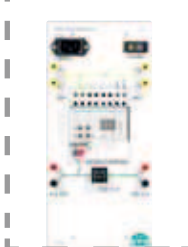

DALI Power Supply Board Dali Touch Panel



Low & high voltage lamps Board



or

Color Touch Panel



High pressure sodium lamp Board

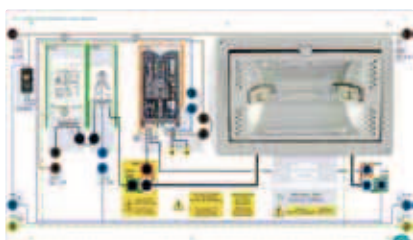

LED Lamps Board CV



Metal halide lamp Board

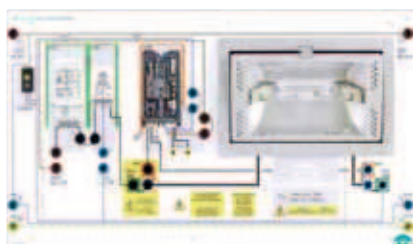

DALI Gateway -V2



DALI Power Supply Board Dali Touch Panel



LED Lamps Board CC



or

LIGHTING TECHNOLOGY

Light technology with DALI bus system

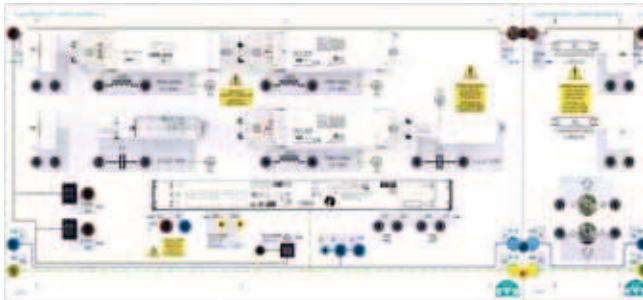

1 2



3



4

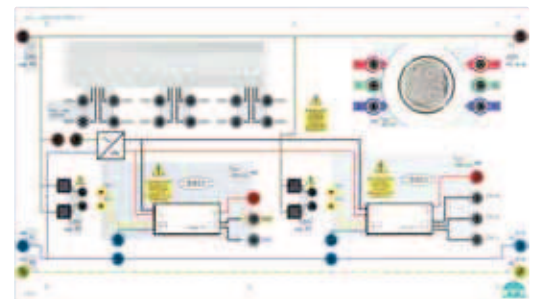

5

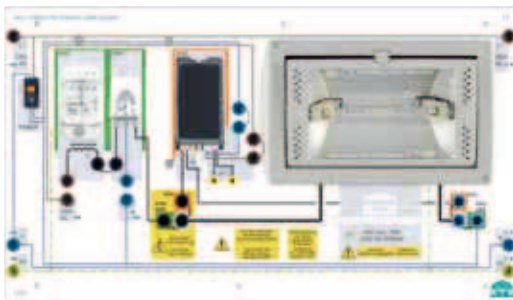

6

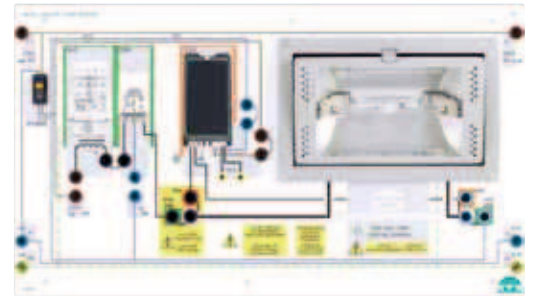

7



No.	Designation	Order No.
1	Flourescent Lamps Board A II	43200
2	Flourescent Lamps Board B II	43201
3	Incandescent Lamps Board	43204
4	LED Lamps Board CV	43206
5	LED Lamps Board CC	43207
6	High Pressure Sodium Lamp Board	43208
7	Metal Halide Lamp Board	43209

Catalog Lighting Technology

ETS DIDACTIC GMBH
ELABO Training Systems



InstALLAtion enGIneeRInG

Lighting technology



Overview of topics:
LED, temperature radiators, special lamps
with DALI system



Alarm systems / Fire alarm systems

Technical alarms / access control

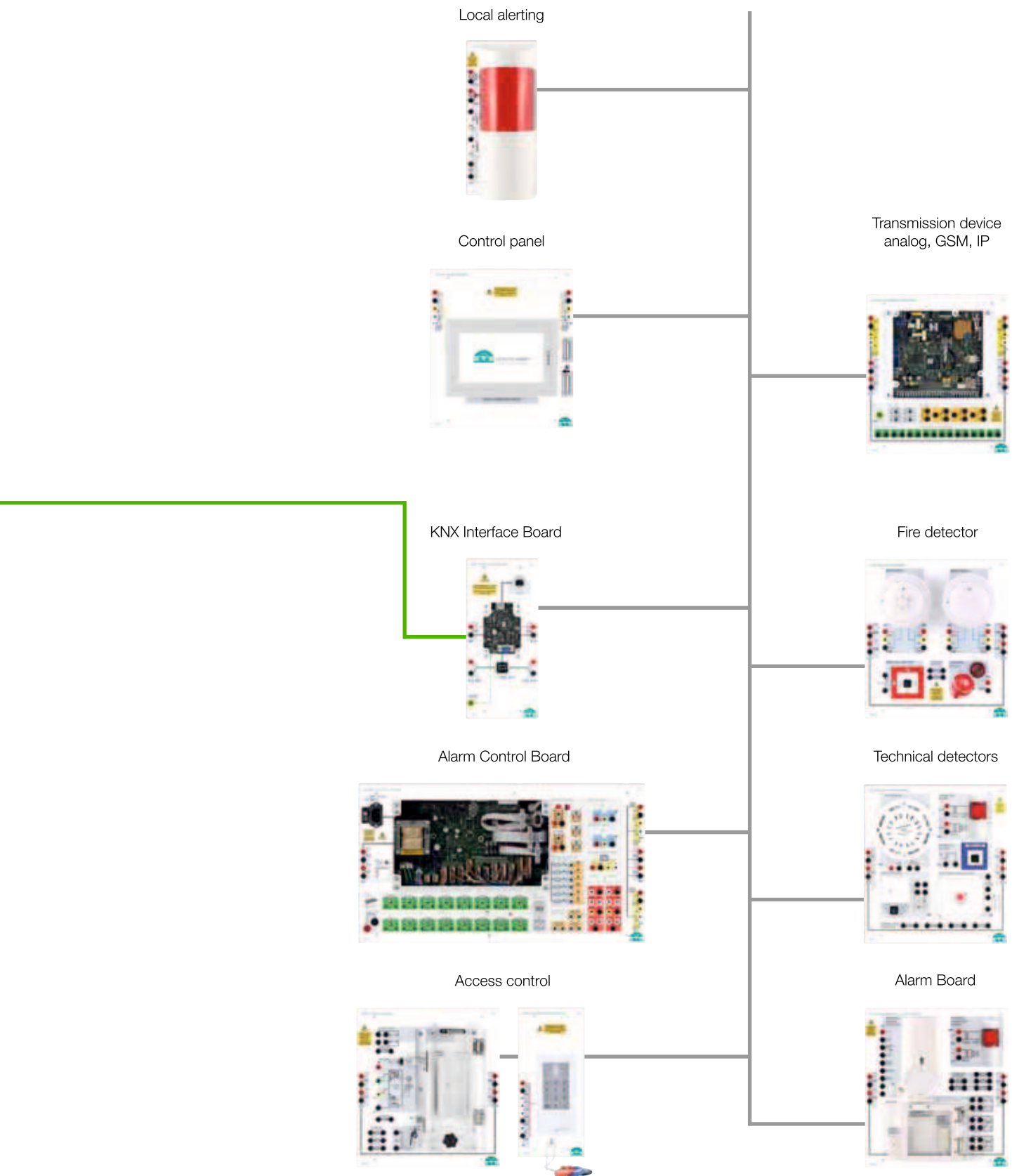

HAZARD ALARM SYSTEMS

Project planning and commissioning of plants



1



2

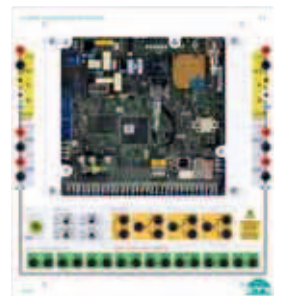

3



4



5



6



7



8



9

No.	Designation	Order No.
1	Alarm Control Board	45040
2	Touch Panel Board	45041
3	Alarm Transmission Board	45049
4	Entry Door Board	45043
5	Burglar Passive Alarm Board	45045
6	Technical Alarm Board	45047
7	Fire Detector Board	45046
8	RFID / Keypad Reader Board	45042
9	Warning Device Board	45044

Catalog Hazard Detection Systems

ETS DIDACTIC GMBH
ELABO Training Systems



hazard alarm systems
Project planning and commissioning of plants



Overview of topics:

Instusion detector, Technical detector,
Fire detector, KNX communication





KNX TOPOLOGY

PARAMETRIES OF LINE / AREA COUPLERS

KNX NETWORK

KNX / LINE Backbone IP Coupler

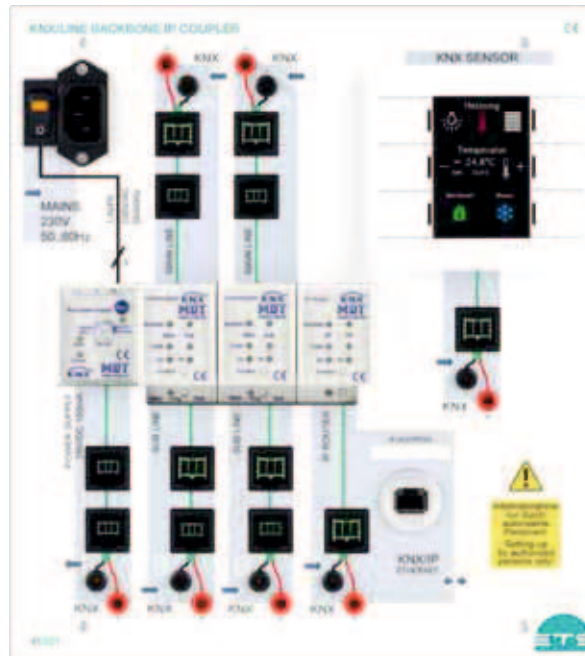

1

Learning objectives

- › Insert line / area coupler
- › Parameterization of line / area couplers
- › Create filter tables
- › Evaluate routing counter content
- › Commissioning and troubleshooting
- › Lien area coupling via IP
- › Programming via IP
- › Parameterize KNX Secure
- › Parameterize KNX Secure and put it into operation

Technical data

KNX system line / area coupling consisting of the following components:

- › Power supply KNX
- › Two line / area couplers KNX Secure
- › IP Router KNX Secure
- › Touch sensor with LCD display

No.	Designation	Order No.
1	KNX / LINE Backbone IP Coupler	41021

COUPLING LINES VIA ETHERNET

Commissioning via LAN / WLAN

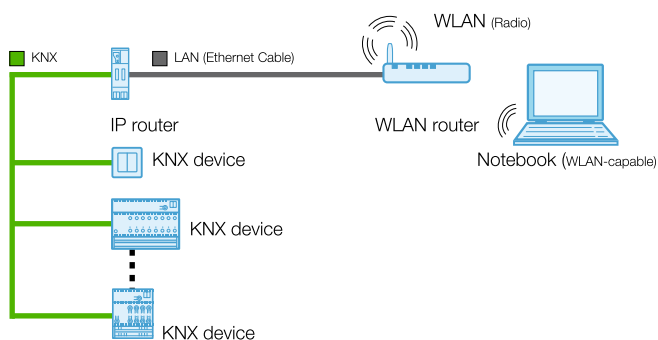

Procedure

Connect the IP router to the KNX bus. Connect the WLAN router to the IP router via the Ethernet cable. Now you can go with notebook and the ETS to the individual rooms.

Advantages

- › Wireless KNX commissioning via WLAN
- › Free movement in the building
- › Commissioning by only one person possible

Remote access via Internet (DSL)

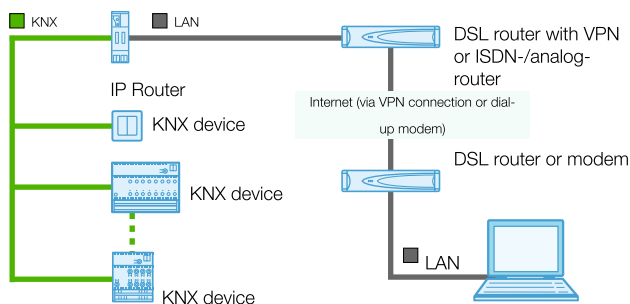

Procedure

1. connect IP router to the KNX bus
2. connect IP router to LAN
3. configure VPN-DSL router or dial-in router

Advantages

- › Parameters can be changes quickly by remote access
- › Cost reduction through remote access (no need to travel)
- › Guarantee of data security

Coupling lines via Ethernet (LAN)

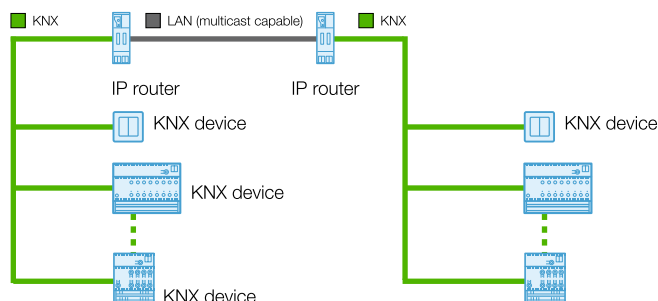

Procedure

1. connect IP router to each KNX line (instead of a line coupler)
2. connect IP routers via multicast capable LAN
3. Operate each IP router like a "conventional" line / area coupler with the ETS5

Advantages

- › LAN as main and area line
- › Data transmission over longer distances possible
- › Use of existing data networks and components (LAN)

LINE COUPLER

Classical Topology

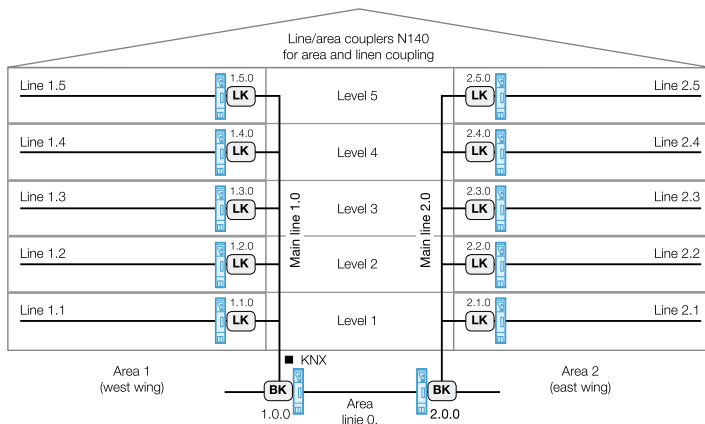

In the classical topology, all the line and area couplers are traditionally configured as KNX couplers.

This topology is proven and used extensively. The bus line lengths are mostly limited to one building.

Modern Topology

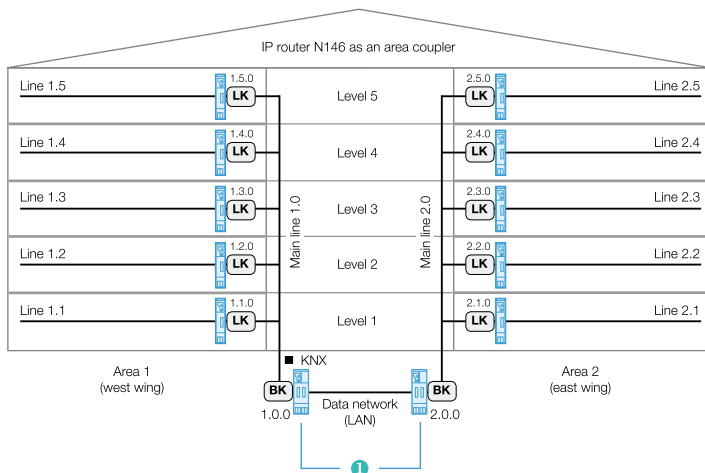

In this modern topology, the area couplers are replaced by IP routers 1.

Owing to the use of standard network components, the connection of e.g. two parts of a building is not limited to bus line lengths.

Even other media like fibre optic cables or W-LAN can be employed to couple to remote buildings and to exchange group address telegrams.

Innovative Topology

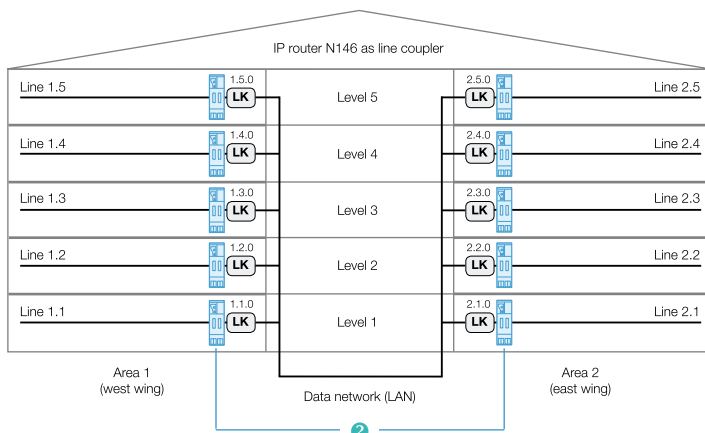

In innovative topology, all the line couplers are replaced by IP routers 2.

The use of area couplers is not necessary any more. This configuration allows connecting every individual floor via Ethernet (LAN) and using existing LAN networks.

Moreover, through the correct configuration of the IP router, large projects can be commissioned more clearly and easily in the form of smaller individual projects.

An exchange of group address telegrams is possible despite the division into individual projects..

Line/Area Coupling

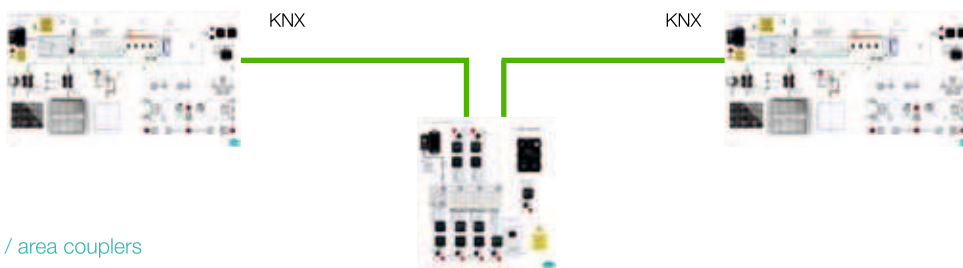

Use of KNX line / area couplers

Commissioning via LAN

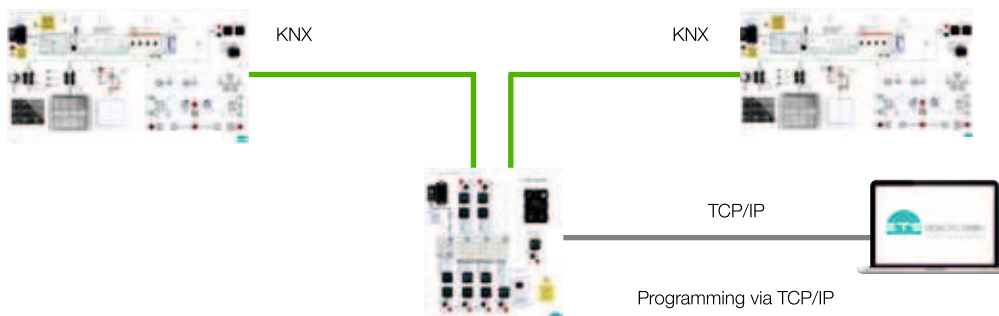

Use of KNX line / area couplers and IP router

Area Line via TCP/IP

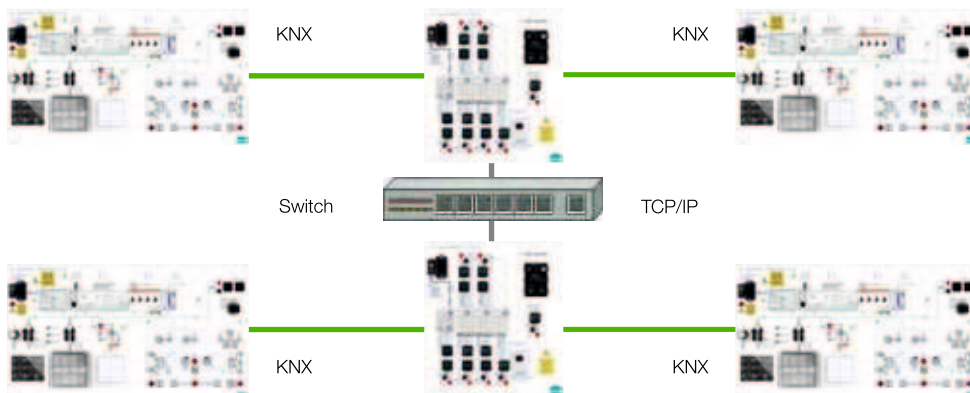

Use of KNX line / area couplers and IP router

Line Coupler via TCP/IP

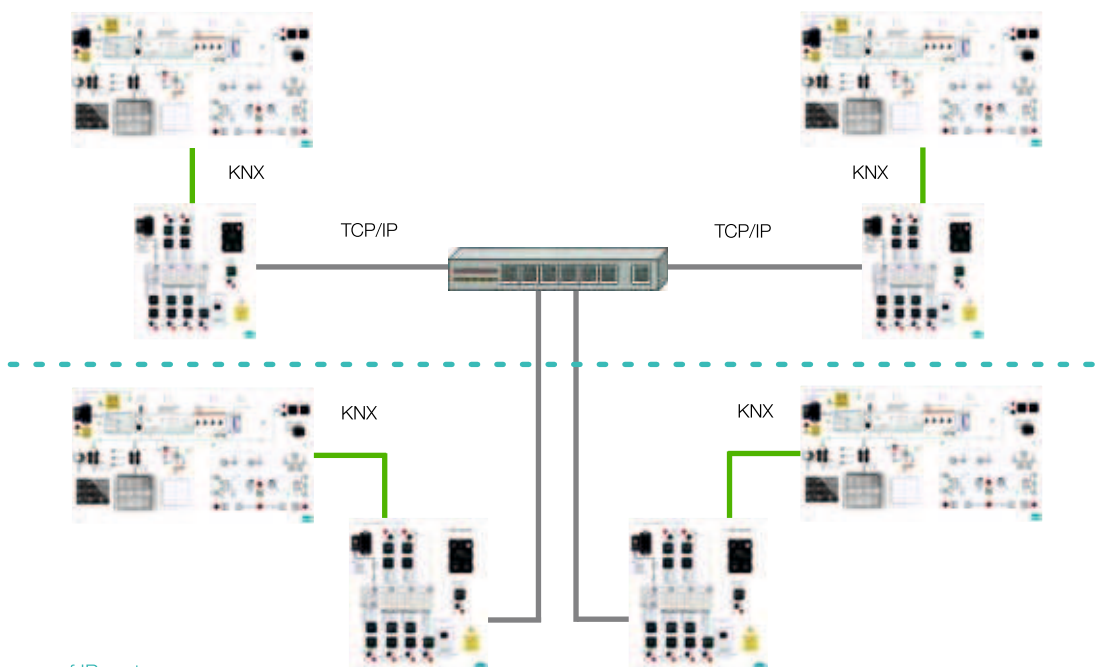

Exclusive use of IP router

KNX/LINE BACKBONE IP COUPLER

Expand KNX bus systems

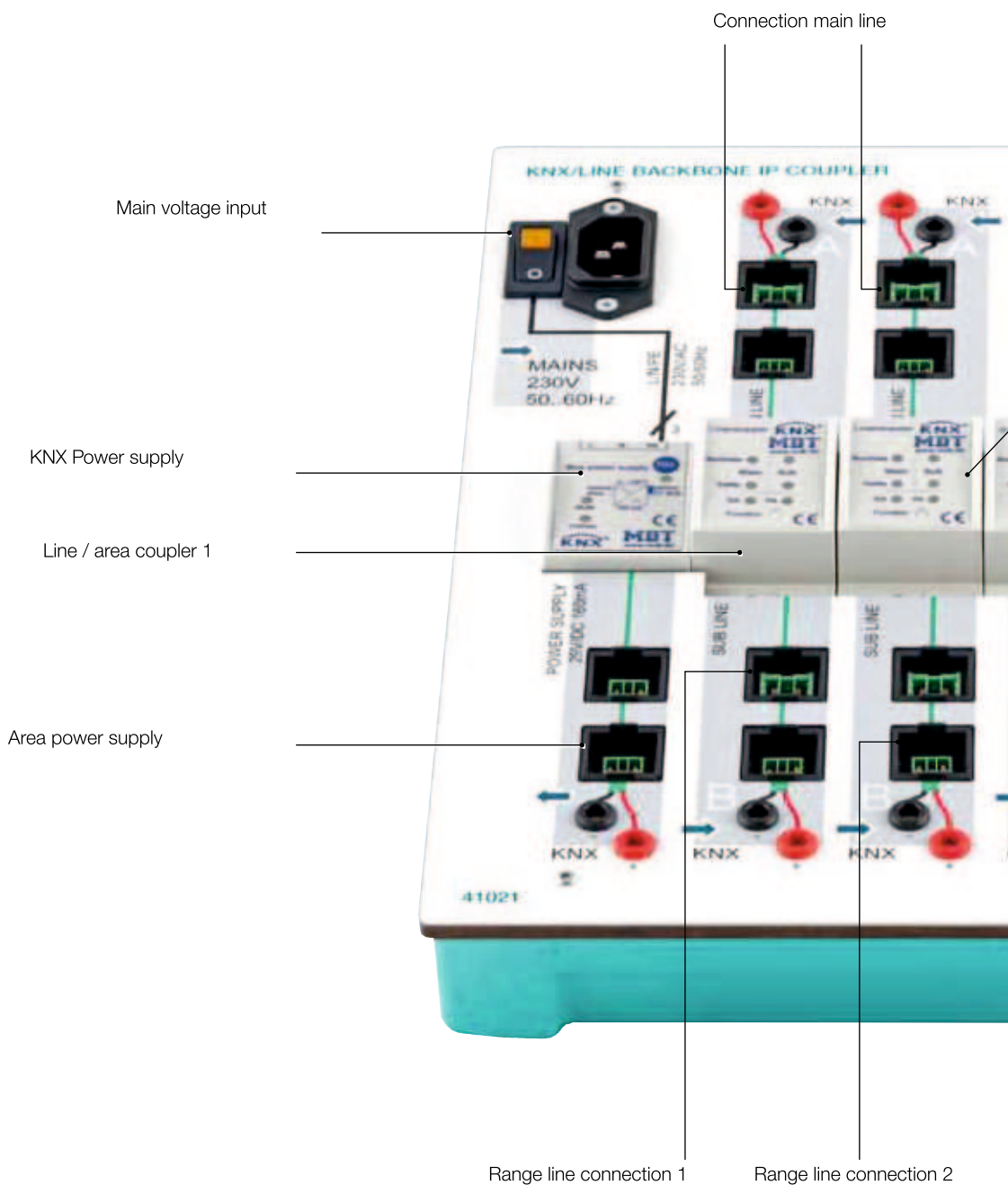

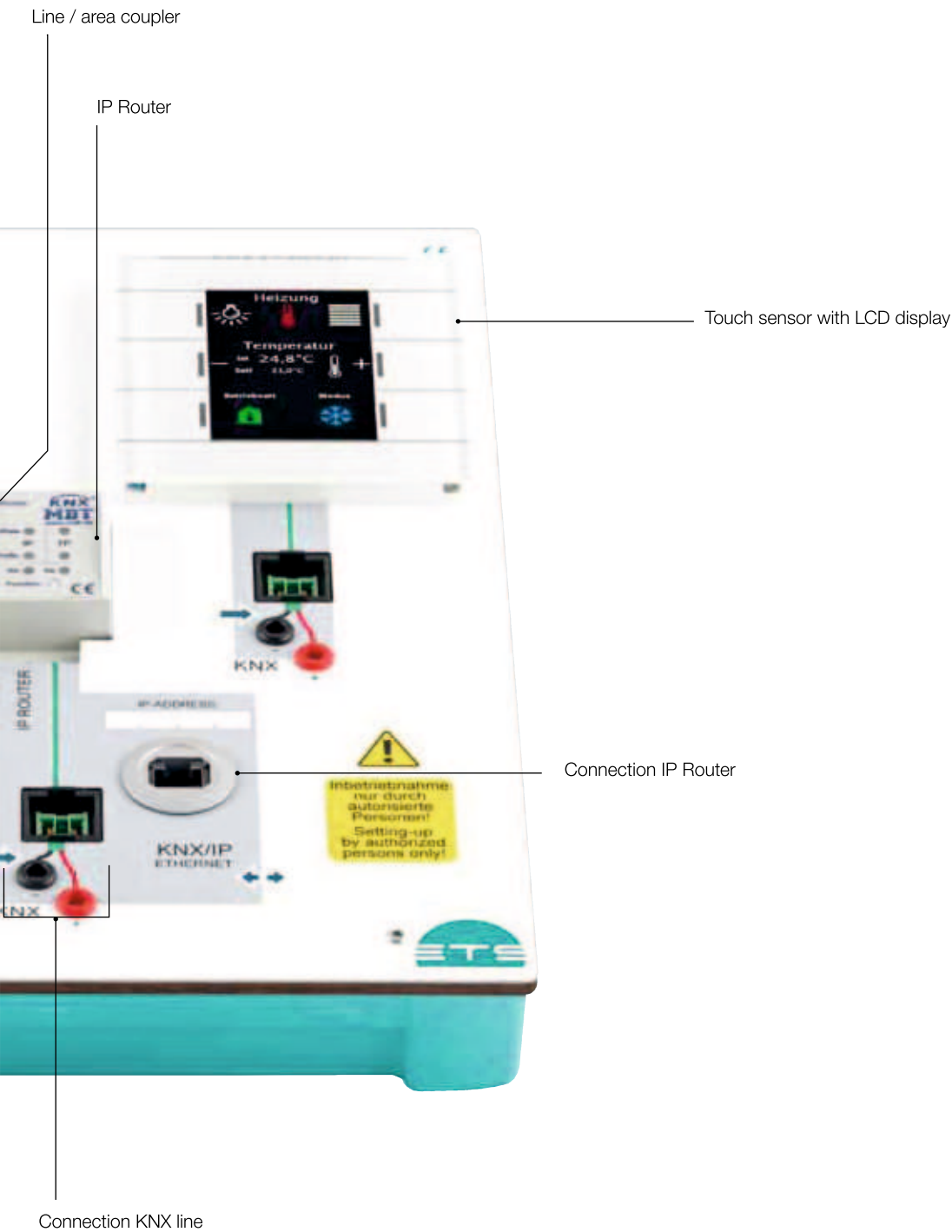

GATEWAY DALI LIGHTING CONTROL

KNX DALI Gateway

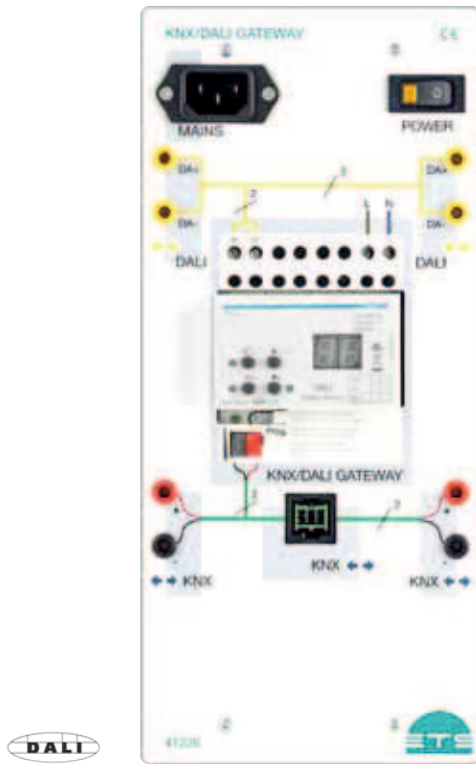

1

Learning objectives

- › Project planning of KNX systems
- › Commissioning and troubleshooting
- › Commissioning of a DALI bus system
- › Integration of the DALI bus system into a KNX system
- › Documentation and maintenance

Functions

- › Time functions like:
 - Time switch operation
 - Night operation
 - Warn before switching off
- › Dimming
 - Brighter/darker
 - Brightness limitation
 - Adjustable dimming time
- › Switching
 - On/Off
 - On/Off via dimming
- › Control of Tunable White luminaires (DALI DT8)
- › Status
 - DALI short circuit
 - DALI power supply
 - Status outputs
 - Status EVG

Technical data

- › DALI interface for the integration of up to 64 DALI devices
- › DALI bus voltage: approx. 19 V DC
- › KNX bus connection
- › Main voltage: 110 – 240 V AC 50 / 60 Hz
- › All inputs and outputs are connected via safety sockets (2 mm)

No.	Designation	Order No.
1	KNX/DALI Gateway	41226

DALI DIGITAL ADDRESSABLE LIGHT INTERFACE

What is DALI?

DALI is an independent multi-master system (several control units in one bus system). It can operate as an autonomous lighting management system and can also be connected to a higher-level building management system. DALI works as an addressable, bidirectional communication management system in which control devices receive feedback from the components of the system. The DALI protocol was internationally standardized in 1999 in IEC 62386. DALI is an open standard for LED control gear and ballasts. Switches and sensors are defined in the DALI-2 standard.

DEVICE TYPE - DT

In the DALI standard, devices are divided into nine different types:

- › DT0, DT2 and DT3 describe fluorescent and halogen lamps
- › DT4 is used for phase dimming of 230V luminaires e.g. incandescent lamps and retrofit LED lights
- › DT5 are signal converters that convert DALI signals into convert analog dimming signals e.g. 0-10V
- › DT6 is used for single color LEDs - 1 channel
- › DT7 is the pure ON/OFF function e.g. relay modules
- › DT8 is used for color management
 - Tunable White and RGB / RGBW

CONSTRUCTION OF A DALI SYSTEM

A DALI system includes the following components:

- › DALI bus supply: Each DALI circuit needs a bus supply
- › Control devices: These are devices that send DALI commands and thus control operating devices (e.g. key couplers, rotary dimmers, touch panels and many other control elements).
- › Control gear: DALI ballasts and actuators (e.g. DALI LED dimmers) which can be adjusted based on stored parameters and received DALI commands operate a light source accordingly. The simplest DALI circuit thus consists of a device for the DALI bus supply, a control device that sends commands and an operating device that receives and executes the commands.

COMMISSIONING AND CONFIGURATION OF THE DALI BUS

With the PC program DALI Cockpit and a DALI USB interface a DALI system can be addressed and configured.

ADDRESSES, GROUPS AND SCENES

An operating device can be controlled by means of DALI commands. The effective range of a DALI command is defined by the target address contained in the command. A distinction is made between individual addresses, group addresses and broadcast (entire DALI bus). Groups: Commands to groups can be used to switch and dim entire areas together. Up to 16 groups can be created in the DALI system, each DALI device can belong to one or more groups. Scenes: Each DALI device has a memory for 16 scenes. A DALI scene is an operating state, e.g. dimming value or color adjustment of a luminaire. The scene call can be sent to the device directly, to a group or to the entire DALI bus (broadcast).

DALI FACTS

- › up to 64 addressable DALI control gears
- › up to 16 DALI groups
- › up to 16 DALI scenes
- › DALI bus voltage: 12V to maximum 22.5V (standard 16V)
- › DALI system current: <250mA
- › Data transmission speed: 1200Baud (asynchronous interface)
- › Cable length up to 300m (with 1.5mm² conductor cross section), resulting from the permissible voltage drop on the DALI line of maximum 2V.

INTEGRATION OF DALI

Integration into KNX systems is possible via a DALI/KNX gateway. For control and monitoring, DALI systems can be connected to a superordinate building management system (BMS).



L1

FAN SPEED

WEATHER STATION

A weather station module featuring a fan speed control knob, a green and red indicator light, and a red L1 indicator. A label 'WEATHER STATION' is visible. A green line traces a path through the module.

Warning symbol: High Voltage (Yellow triangle with lightning bolt)

MULTIFUNCTIONAL UNIT CONNECT (100V 50/60Hz)

A large multifunctional unit with a warning symbol, a digital display, and various control buttons. A label 'MULTIFUNCTIONAL UNIT CONNECT (100V 50/60Hz)' is visible. A green line traces a path through the unit.



KNX BST®

COMPACT COMPLETE MOBILE

KNX INSTALLATION TECHNOLOGY

BST® Building Systems Trainer

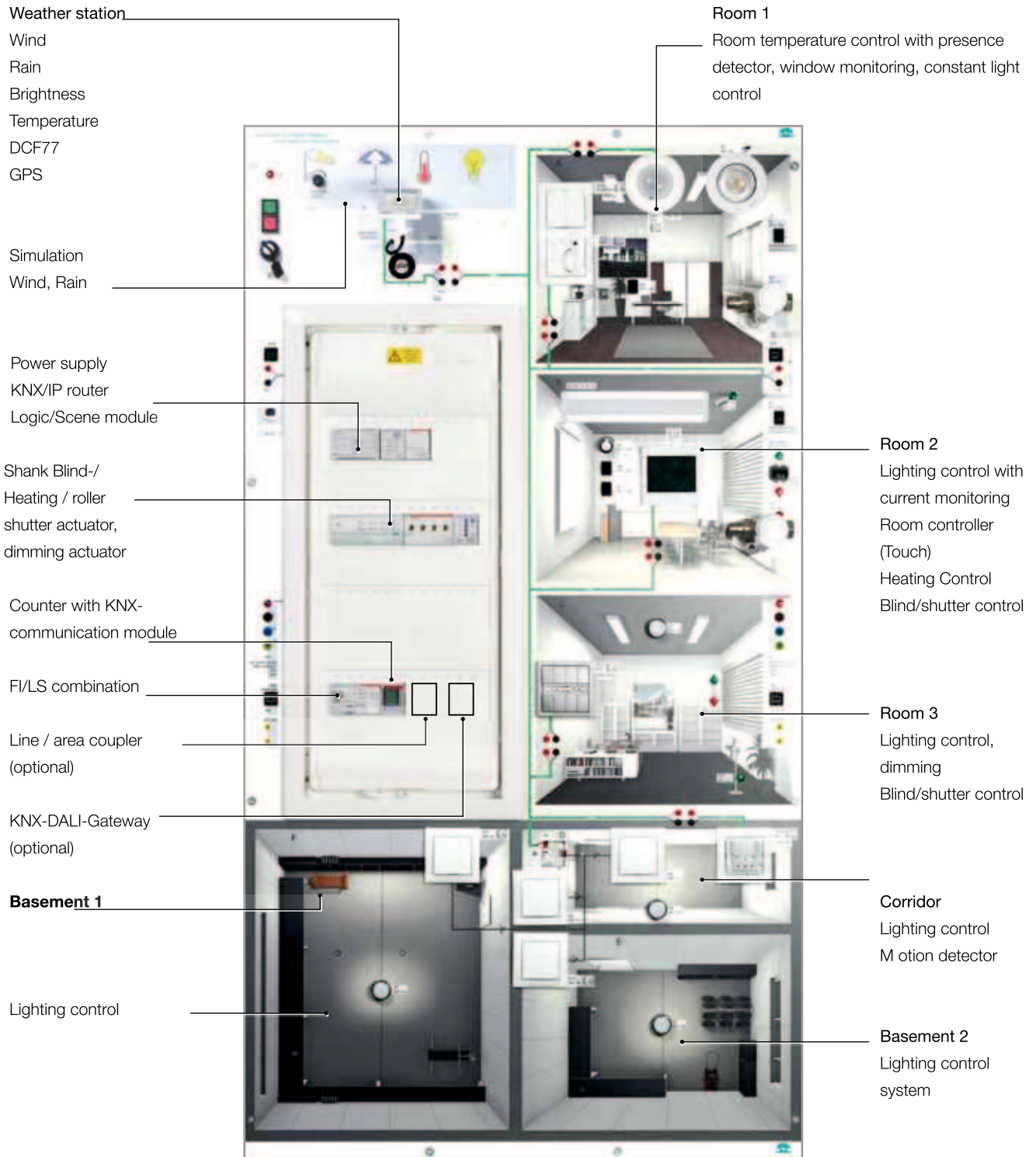

BST® Building Systems trainer Installation Technology

Target group

- › Electronics technician specializing in energy and building services engineering (EFEG)
- › Electronics Technician for Building and Infrastructure Systems (EGI)
- › Electronic Technician for Industrial Engineering (EBT)
- › Technical college for technology
- › Master school

Learning objectives

- › Planning and configuring of KNX systems
- › Commissioning and troubleshooting
- › Extension of existing systems
- › Documentation and maintenance
- › Networking of existing KNX systems
- › Optional use of line/area couplers

Technical Features

- › Rooms can be activated individually
- › Various designs of KNX participants
 - Rail-mounted devices
 - Flush-mounted devices
 - Room automation box
 - Control and display devices
- › Many manually operated devices
- › Realistic arrangement of the components

Advantages

- › Saving of expenses (integrating fundamentals and complex project in a single device)
- › Flexible use (movable)
- › Fast training for trainers (didactically prepared documents)
- › Realistic assembly of components



Training stand be equipped on both sides!

No.	Designation	Order No.
1	BST® KNX Technology	43541
2	Training stand BST® 1800	43501

PROJECT

KNX Project: Dimming

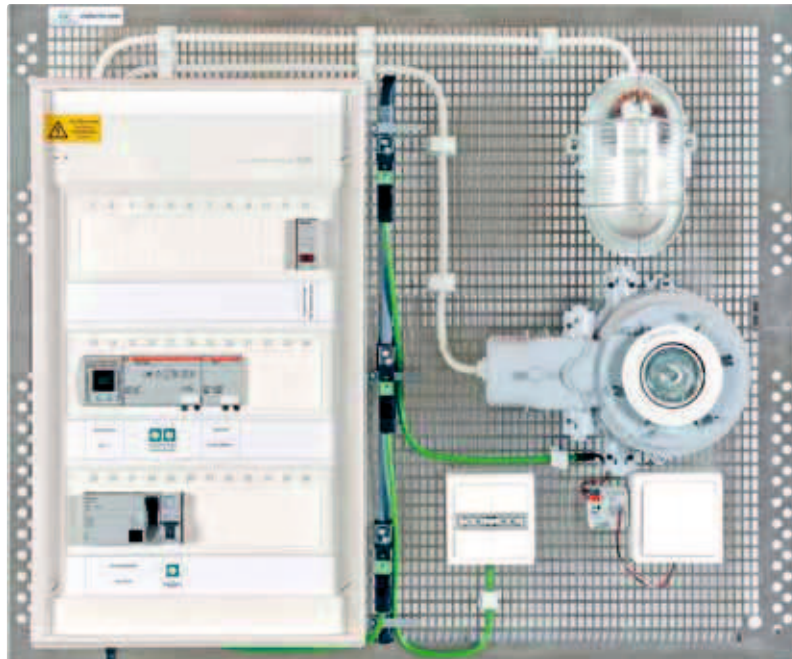

1

Learning objectives

- › Switching ON/OFF
- › Dimming (relative and absolute) 0 % – 100 % of the adjustable range
- › Continuous dimming value / direct switch-on
- › Integration into a scene control
- › Feedback of the output status and output value via the bus in case of changes
- › Commissioning and troubleshooting

Technical data

Set of circuit components mounted on grid wall consisting of:

- › Small distribution board
- › RCD switch 40 / 0.03 A, 4-pole
- › Circuit breaker type B10A, 1-pole
- › Universal dimming actuator 2 x 300 W
- › 2-fold push button sensor with bus coupler and surface-mounted housing
- › 2-fold push-button interface with series button
- › Incandescent lamp E27
- › Electronic ballast for halogen lamps and surface-mounted lamp
- › Scene and logic modules
- › Set of KNX system cables with branch and connecting cable
- › Set of wiring and distribution accessories

No.	Designation	Order No.
1	Project – KNX dimming	41012

Dimming by Universal Dimming Actuators

Sinusoidal voltage

230 V 50 Hz

Phase angle control, leading angle

Voltage progression at the load

Phase angle control, trailing edge

Voltage progression at the load

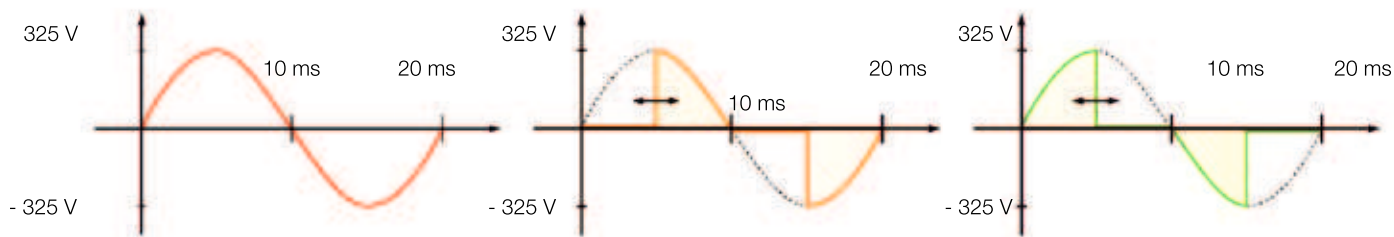

Dimming by means of universal dimming actuators

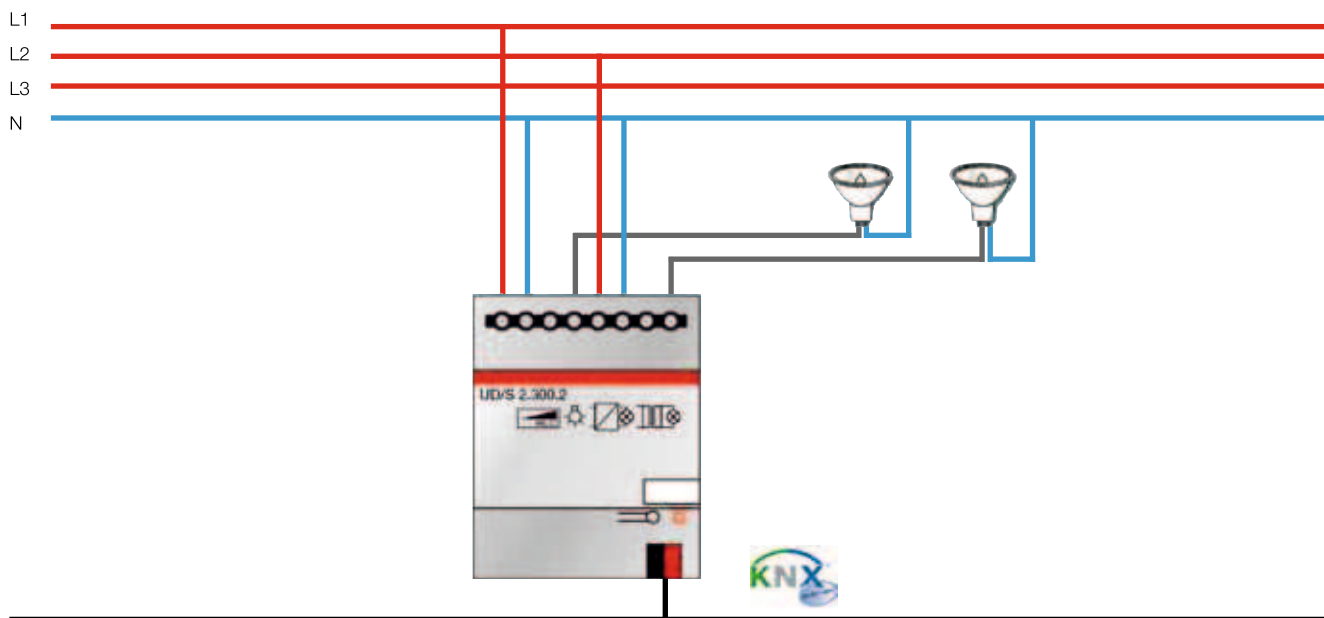

Connection of an incandescent lamp load to the universal dimming actuator

PROJECTS

KNX Project Heating Control

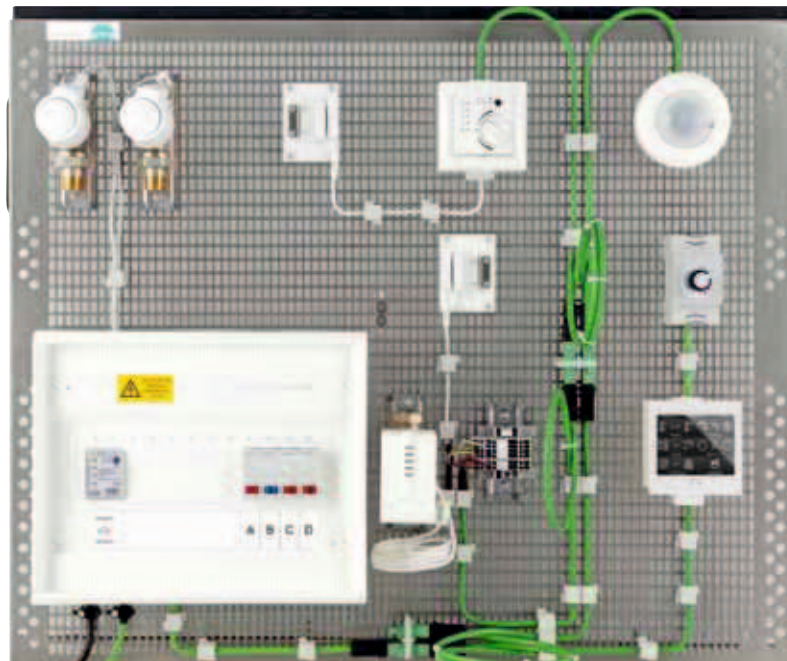

1

Learning objectives

- › Moving to controller output and positions, moving to priority positions as well as finding out the maximum position
- › Heating and cooling functions as well as 2-step heating with basic and additional phase
- › Comfort mode and night reduction mode
- › Testing frost and heat protection as well as stand-by mode
- › Commissioning and troubleshooting

Technical data

Set of circuit components for heating control mounted on grid board consisting of:

- › Electromotoric actuator with 2 binary inputs and 5 LEDs for position indication, mounted on heating valve
- › 2 Electromotoric actuators for 2-point or PWM control
- › 2 Window contacts
- › Presence detector, 2-channel KNX with mounting box
- › Room temperature control with bus coupler
- › Room temperature control with touch LCD Display, bus coupler
- › KNX heating actuator with integrated controller
- › Set of KNX system cables with branch and connecting cables
- › Set of wiring accessories

No.	Designation	Order No.
1	Project Heating Control KNX	41011
2	Heating Control Board	41031
3	Set of ETS ring binders	91905
4	KNX Heating Control – Instructor's Manual	41267CD-ENG
5	KNX Heating Control – Student Manual	41268CD-DENG
6	TECHNOCard® Project Heating	41218-DENG

Heating Control Board

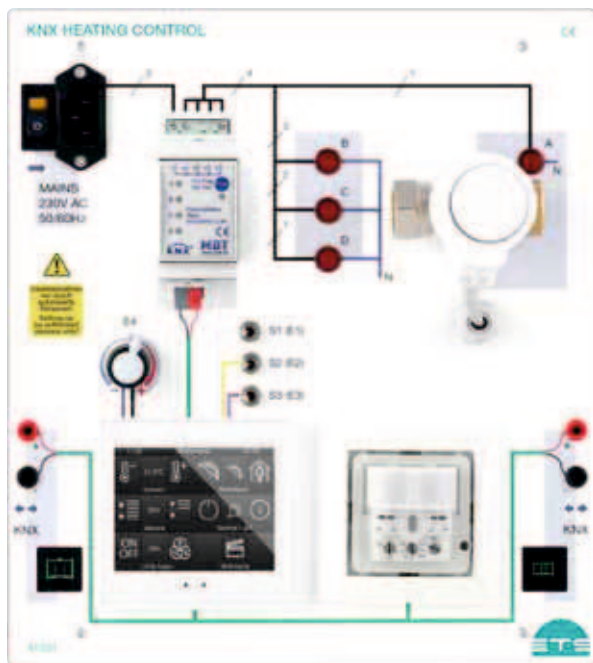

Technical data

- › Electrothermal actuator for 2-point or PWM control
- › 3 Simulation switch
- › KNX motion detector with integrated thermostats
- › Touch room controller with integrated thermostats
- › KNX heating actuator with integrated controller

Information about KNX heating control can be found on page 24.

2

Courseware for heating control



3

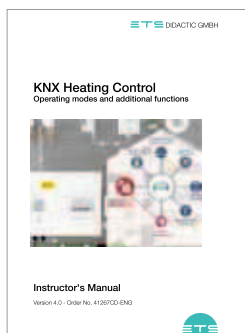

4

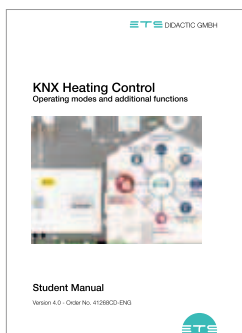

5

Contents of Manual

- › Operating mode 2 point control
- › Operating mode continuous 1 byte
- › Operating mode integrated controller
- › Energy saving
- › Heating control fundamentals

Printed and digital

TECHNOCard®

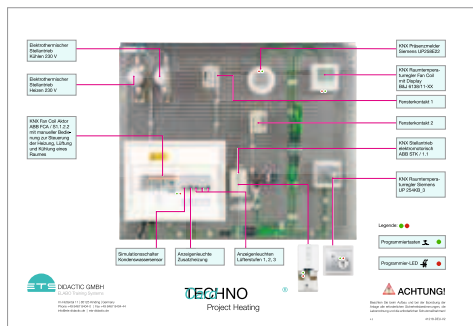

6



TRAINING PACKAGE SMART HOME MANAGER

Controller with PLC Functionality and Innovative Web- / IT-Technology

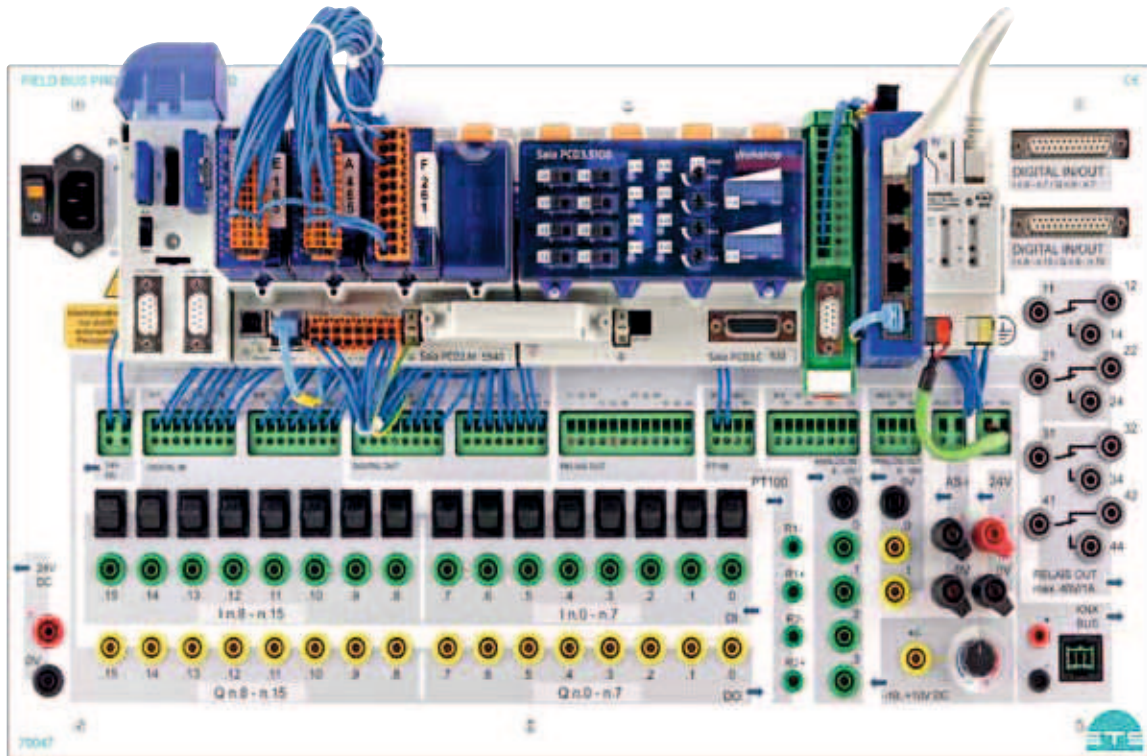

1

Learning objectives

- › Designing energy management systems
- › Visualization of energy systems and their energy flows
- › Installation and commissioning of measuring, control and regulation systems
- › Integration of various bus systems in a management station
- › Maintenance and service of building-integrated automation units

Technical data

- › Controller with SPS functionality and innovative web- / IT technology
- › Digital inputs DC 24 V
- › Digital outputs DC 24 V / 0,5 A
- › Processing time: 0,3...1,5 µs
- › Timer
- › Working memory 1 MB
- › Flash memory 2 MB
- › Flash memory 128 MByte with BACnet Firmware
- › USB interface for programming
- › Ethernet interface
- › Simultaneous use of Ethernet interface for different protocols is possible.
- › RS232 interface
- › RS485 interface on SubD 9pol.
- › RS485 interface on terminal
- › KNX/IP interface
- › DALI master with power supply for 64 DALI devices
- › 5 Port Switch
- › 5 free slots for extension with interfaces or I/O modules
- › Up to max. 13 communication interfaces mounted on: Field Bus Professional Board 70047
- › Integrated power supply 24 V DC / 4.5 A
- › 16 digital inputs, 16 digital outputs 24 V DC
- › Si sockets, 4 mm, for digital inputs and outputs
- › Simulation, pushbutton - / Rast switch for digital inputs
- › Simulation components with: 8 Di, 4 Ai, 8 Do, 2 Ao
- › Simulation field for analog processing
- › System interfaces Sub D 25-pole
- › Terminal for external consumers
- › Short-circuit protection of digital outputs

Courseware



2

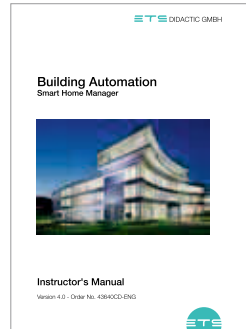

3

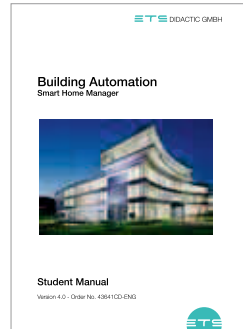

4

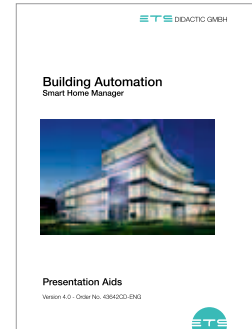

5

Printed and digital

Content of Manual

- › Fundamentals
- › Programming methods in Saia PG5® Core
- › Commissioning of basic controller
- › Recording of consumer data of energy counters
- › Lighting control and visualization
- › Lighting control via visualization
- › Recording of consumer data via Modbus TCP energy measurement instruments
- › Connection of a KNX installation
- › Connection of a DALI installation
- › Coupling to BACnet

No.	Designation	Order No.
1	Smart Home Manager	43600
2	Set of ETS ring binders	91905
3	Building Automation / Smart Home Manager – Instructor's Manual	43640CD-ENG
4	Building Automation / Smart Home Manager – Student Manual	43641CD-ENG
5	Building Automation / Smart Home Manager – Presentation Aids	43642CD-ENG
6	Bulb Socket Board	43126
7	Power Quality Analyzer Board	40307
8	Set of lamps	43122
n. ill.	Programming system for Smart Home Manager	43610
n. ill.	Set of Industrial Ethernet RJ45 connectors	70033
n. ill.	Industrial Ethernet line 2 x 2 (spiral quad)	70034
n. ill.	Stripper for industrial Ethernet line	70035
n. ill.	RS485 Bus cable set	43620
n. ill.	PROFIBUS DP connection cable	55926
n. ill.	Industry Ethernet cable	C805152
n. ill.	KNX programming environment ET S 5 Lite	90144
n. ill.	KNX programming environment ET S 5 Trainer Package (optional)	90146
n. ill.	ET S Licence administration	90148
n. ill.	KNX Professional Connection Line (optional)	41002

Optional Accessories



6



7



8

SMART HOME MANAGER

BST® Building Systems Trainer

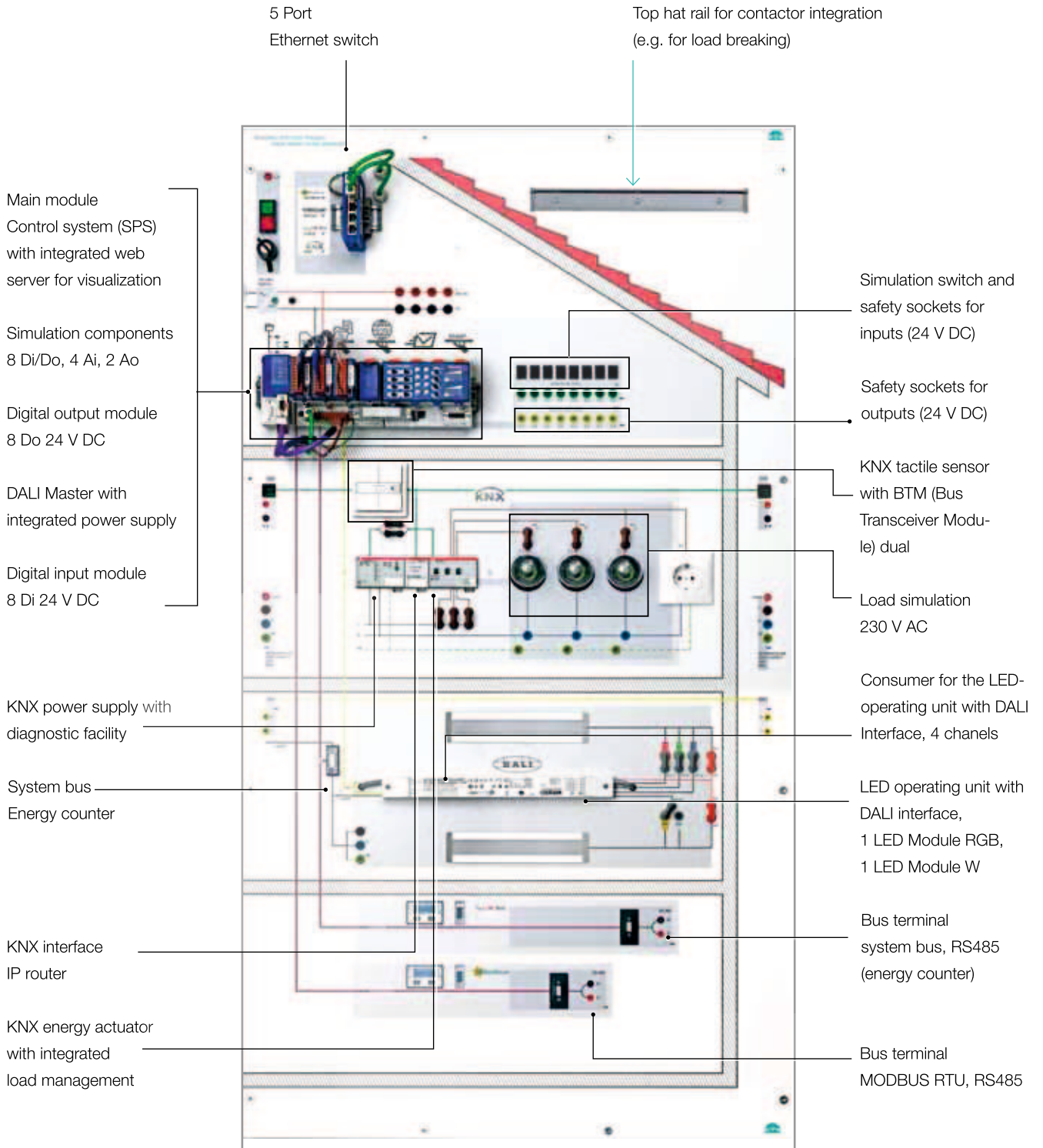

BST® Building Systems Trainer Smart Home Manager

Target group

- › Electronics technician specializing in energy and building services engineering (EFEG)
- › Electronics Technician for Building and Infrastructure Systems (EGI)
- › Electronics Technician for Industrial engineering (EBT)

Learning objectives

- › Planning of energy management systems
- › Visualizing of power distribution systems and their energy flow
- › Installing and commissioning measurement and control systems
- › Integrating various bus systems into a management station, e.g. KNX, ModBus, DALI, BACnet
- › Maintenance and service of building-integrated automation units
- › Planning of energy management systems on a KNX basis
- › Planning of lighting control systems on a DALI basis

Advantages

- › Saving of expenses (integrating fundamentals and complex project in a single device)
- › Flexible use (movable)
- › Fast training for trainers (didactically prepared documents)
- › Realistic assembly of components

Supported Bus System

- › BACnet
- › KNX IP
- › Modbus RS485
- › DALI
- › Modbus TCP / IP
- › S-Bus RS485
- › S-Bus IP

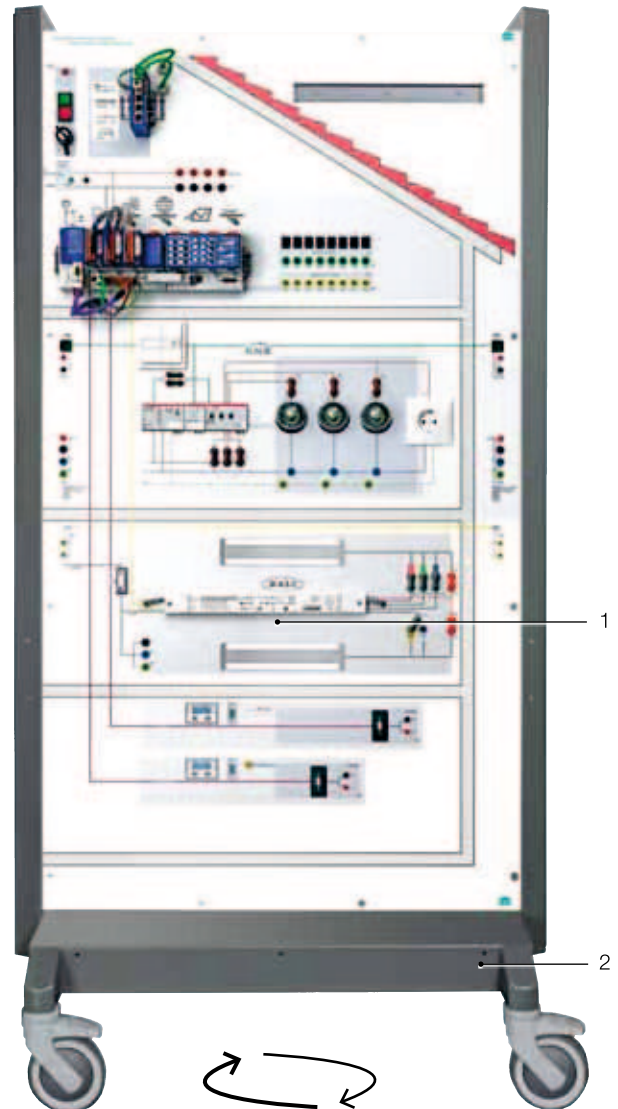

Training stand can be equipped on both sides!

No.	Designation	Order No.
1	BST® Smart Home Manager	43630
2	Training stand BST® 1800	43501

LOGO!

PLC Board 230 V with LOGO! / KNX Module

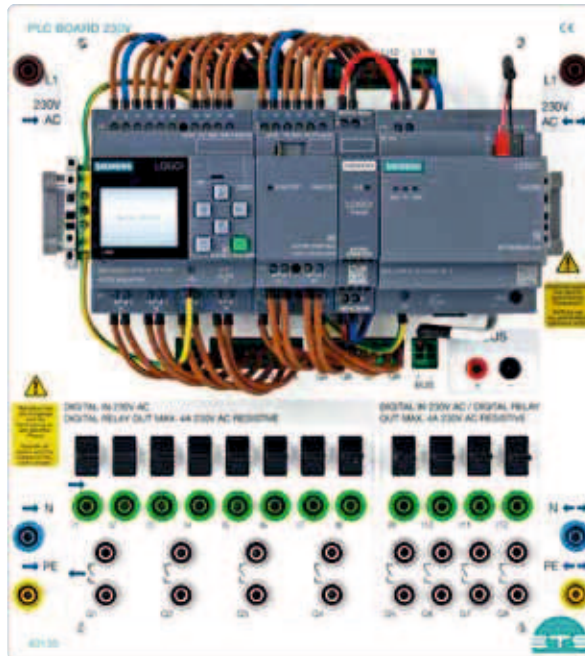

1

Learning objectives

- › Connecting logic modules and testing basic functions
- › Implementation of circuit diagrams in function-plans
- › PC programming, visualization and documentation of applications

Functions

- › Integrated display panel with backlighting and operating panel with buttons
- › Memory EPROM for switching program and internal set values
- › 12 inputs
- › 8 relay outputs 10 A max.
 - 10 A with resistive load
 - 3 A at inductive load
- › 8 integrated timers
- › 12 pushbuttons / switches for input simulation

No.	Designation	Order No.
1	PLC Board 230 V with LOGO!	40135
2	PLC Board 230 V	40090
3	KNX Expansion Module	40095
4	Network cable	C805152
5	Software LOGO!Soft Comfort (school licence)	40808

PLC Board 24 V and KNX Expansion Module

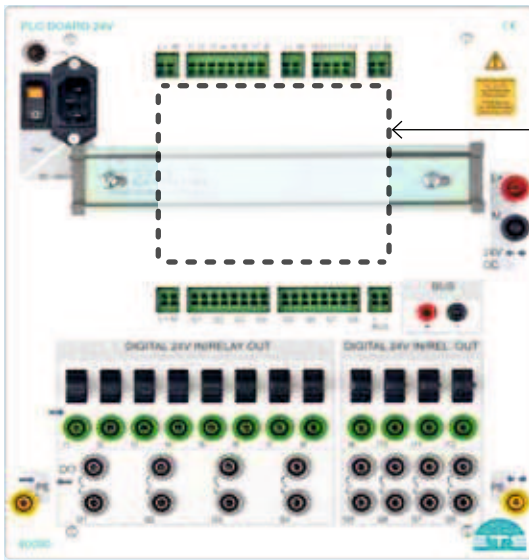

2



3



4



5

DIDACTIC SOLUTION FROM ET S

Catalog „Building Communication“

ETS DIDACTIC GMBH



BUILDING COMMUNICATION

Commissioning of VOIP and classic call systems



Catalog „Installation Engineering – Lighting Technology“

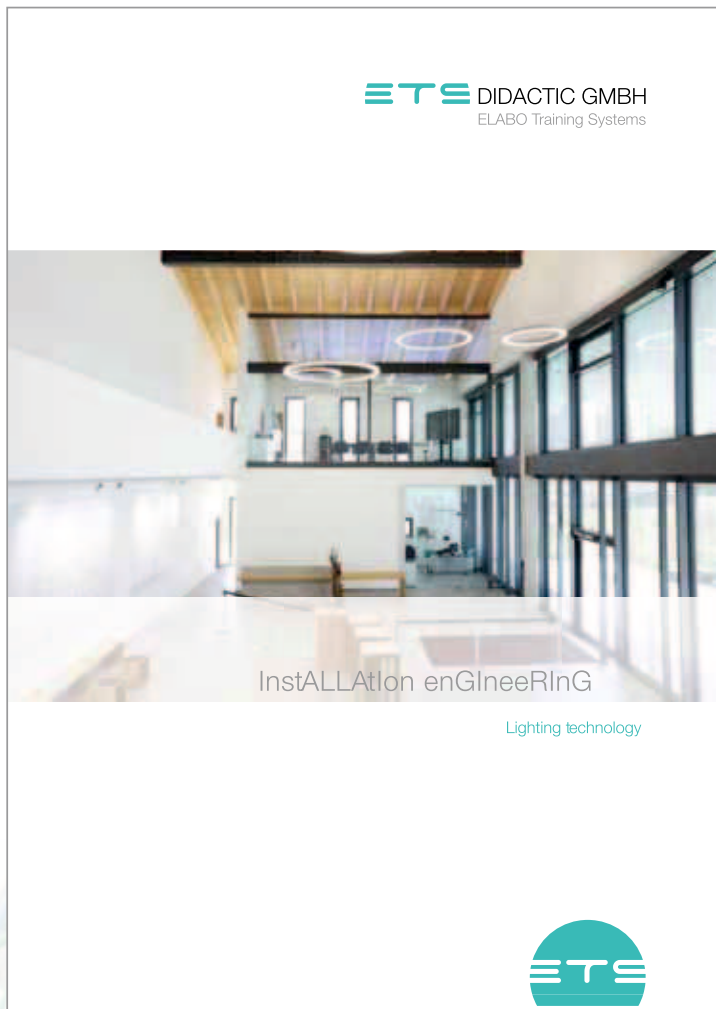

STAY CONNECTED

with us on Social Media

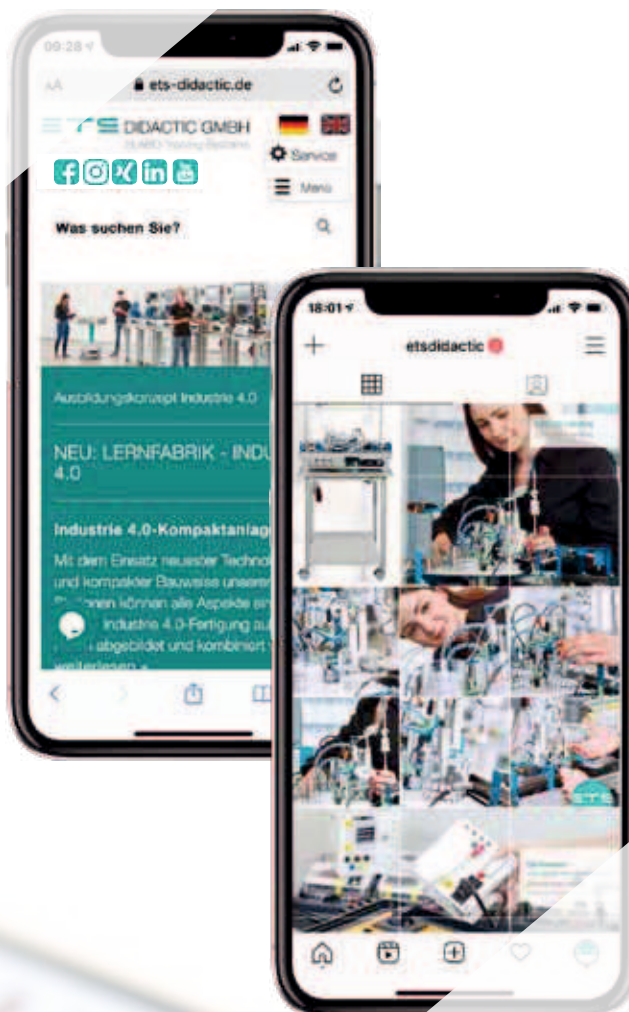



QUALITY IS THE MEASURE OF ALL SUCCESS

Inspiring Technologies

ETS DIDACTIC GMBH is a symbol of high quality and outstanding flexibility. This means that ETS DIDACTIC products are convertible, they can – thanks to the modular conception and the versatile range of accessories – be quickly and efficiently matched to changed requirements and extended nearly without limits.

Our high quality standards refer not only to the products from ETS DIDACTIC, but especially also to the quality of the training that customers achieve thanks to the use of ETS DIDACTIC products. And in this, we also include the process quality: ETS DIDACTIC supports procedures during the training that are as problem-free as possible.

The solutions offered by ETS DIDACTIC can be matched to individual customer requirements to a great extent. Customers of ETS DIDACTIC are supported and accompanied in the successful implementation of their training objectives by a comprehensive range of services.





PLEASE CONTACT US

We are always ready to assist you



Linda Johansson
Service Center



Monday to Friday from 7.45h to 16.30h

Phone: +49 8467 / 8404-0

email: sales@ets-didactic.de

We accompany you and are at your side with active advice. Whether you need information, or some advice in advance of making an investment, or have questions regarding the daily use of the products:

Contact us – we are ready to assist:

ETS DIDACTIC GMBH
Service-Center
Im Hüttental 11
85125 Kinding / Germany

Phone +49 8467 8404-0
Fax +49 8467 8404-44

sales@ets-didactic.de
www.ets-didactic.de



Customer-oriented solutions

- › Presentation, product demonstrations and on-site consultancy
- › Support in the selection of educational systems according to the syllabus requirements
- › Matching of the training systems to customer requirements
- › Working out room concepts
- › Designing ergonomic workstations

Experience

- › Comprehensive range of innovative products
- › Systems and solutions from our own (in-house) production
- › Development and design, technical training systems
- › Quality right from the consultancy up to delivery and onward
- › Trainer workshops / In-house training / Webinars
- › References world-wide
 - Industrial educational institutions
 - Vocational schools / technical schools
 - Chambers of crafts
 - Technical colleges / Universities

We support you

- › Installation and commissioning of the systems on-site
- › Technical support
- › Warranty and repairs
- › Instruction and training
- › Further education, training, seminars
- › Comprehensive product documentation
- › Courseware for instructors and trainees

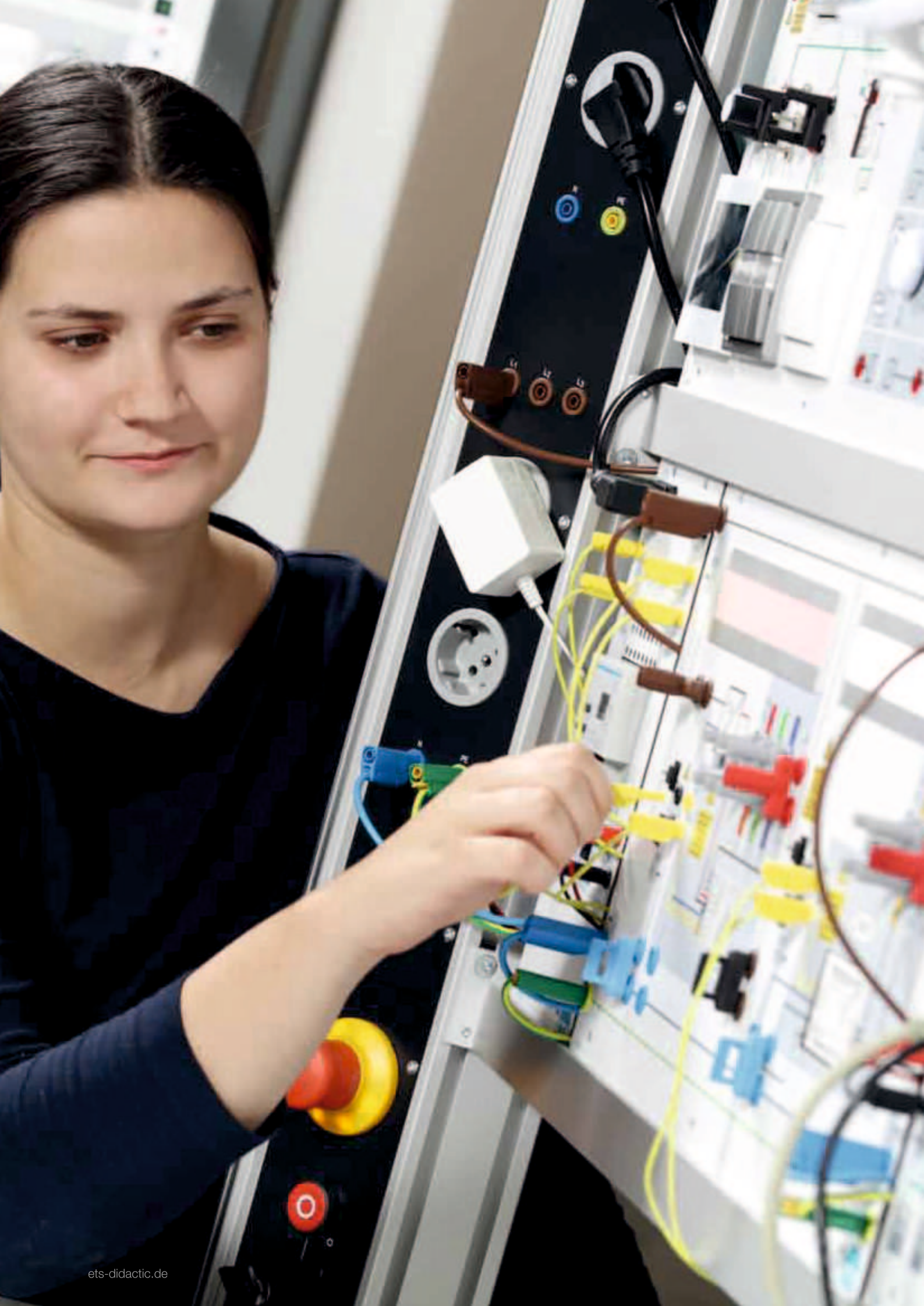

YOUR ENQUIRY

ETS DIDACTIC GMBH

Im Hüttental 11
 85125 Kinding | Germany
 Phone +49 8467 8404-0
 Fax +49 8467 8404-44

We would like:

to receive a list of products

Name, Function _____

Company / Institution / authority _____

Street, P.O. box _____

Zip code, city _____

Telephone _____ Telefax _____

E-Mail _____

Qty.	Designation	Order No.
	KNX Professional Programming Board II	41255
	Set of ETS ring binders	91905
	Installation bus system KNX – Instructor's Manual	41264CD-ENG
	Installation bus system KNX – Student Manual	41263CD-ENG
	Installation bus system KNX – Presentation Aids	41265CD-ENG
	TECHNOCard® – KNX Professional Programming Board	41266-ENG
	Template / Application Circuit-breaking	41251
	Template / Application Heating Control	41252
	Template / Application Office building	41253
	Template / Application Residential Building	41254
	KNX Heating Control	41031
	TECHNOCard® – KNX Heating Control	41241-ENG
	KNX programming environment ET S 5 Lite	90144
	KNX programming environment ET S 5 Trainer pkg.	90146
	KNX Professional Connection Line	41002
	USB Programming Connection Line	80544
	KNX Visualization Server (software included)	41029
	Communication Center	41057
	Bulb Socket Board	43126
	KNX ZigBee Gateway Board	41026
	KNX Colour Touch Panel	41227
	KNX Universal Sensor Board	41030XX
	Smart Home Lighting set	41027
	KNX Weather Station	41022
	Blinds Board	41117
	KNX Programming Board II	41255
	KNX Colour Touch Panel	41227
	Fluorescent Lamps Board A II	43200
	Fluorescent Lamps Board B II	43201
	Incandescent Lamps Board	43204
	LED Lamps Board CV	43206
	LED Lamps Board CC	43207
	High Pressure Sodium Lamp Board	43208
	Metal Halide Lamp Board	43209
	Alarm Control Board	45040

Qty.	Designation	Order No.
	Alarm Transmission Board	45049
	Burglad Passive Alarm Board	45045
	Technical Alarm Board	45047
	Entry Door Board	45043
	Touch Panel Board	45041
	Fire Detector Board	45046
	Warning Device Board	45044
	RFID / Keypad Reader Board	45042
	KNX/LINE Backbone IP Coupler	41021
	KNX/DALI Gateway	41226
	BST®KNX Technology	43541
	Training stand BST® 1800	43501
	KNX Projects Dimming	41012
	KNX Projects Heating Control	41011
	Heating Control Board	41031
	KNX Heating Control – Instructor's Manual	41267CD-ENG
	KNX Heating Control – Student Manual	41268CD-ENG
	TECHNOCard® – Project Heating	41218-ENG
	Smart Home Manager	43600
	Building Automation – Instructor's Manual	43640CD-ENG
	Building Automation – Student Manual	4341CD-ENG
	Building Automation – Presentation Aids	43642CD-ENG
	Power Quality Analyzer Board	40307
	Set of lamps	43122
	Programming system for Smart Home Manager	43610
	Set of Industrial Ethernet RJ45 Connectors	70033
	Stripper for Ind. Ethernet line	70035
	ETS license management	90148
	KNX Professional Connection Line (optional)	41002
	BST® Smart Home Manager	43630
	Training stand BST® 1800	43501
	PLC Board 230 V with LOGO!	40135
	PLC Board 230 V	40090
	Extension KNX	40095
	Software LOGO!Soft Comfort (school license)	40808





Scarica il catalogo completo



Cataloghi digitali, alberi felici:
scegli **Abintrax** che con **mydidactstore**,
abbraccia la sostenibilità!

Concessionario

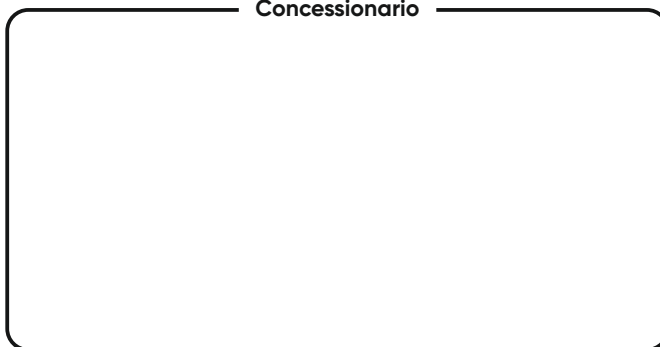

Abintrax s.r.l.
Via Marina del Mondo, 62 | 70043 Monopoli (Ba) Italy
tel. +39 080 2149700 | www.abintrax.com | info@abintrax.com

www.mydidactstore.it