



# Telecomunicazione all'interno di edifici

Progettazione e gestione di sistemi di comunicazione telefonica e sistemi VOIP



ETS DIDACTIC

## BUILDING COMMUNICATION

Commissioning of VOIP and classic call systems

another way to care

Visita il nostro store



[www.mydidactstore.it](http://www.mydidactstore.it)



# Planning and imPlementing communication systems

installation, commissioning and programming of bus-compatible call systems

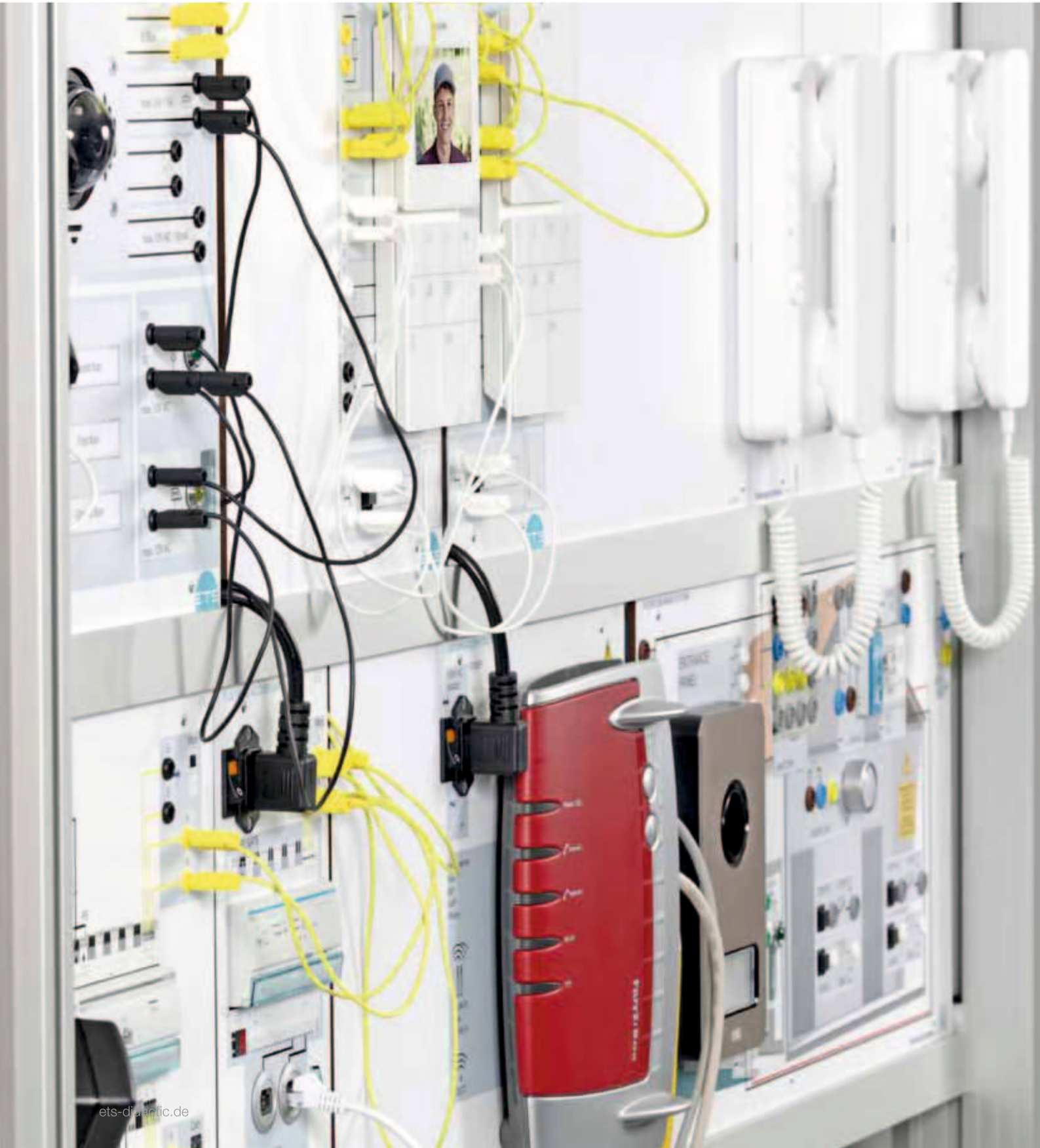

# contents

## didactic solutions

<b>Information</b>	
editorial .....	4
Visit ets in the Valley of River altmühl.....	6
approach and Room concept.....	8
People and technology.....	10
Workshops with ets .....	13
the ets training concept .....	14
<b>Bus-compatible call systems – Voice Over IP</b>	
audio residential station .....	18
Video residential station.....	19
Video door station .....	20
<b>Bus-capable call systems – Bus Video Access Gate</b>	
Video Power supply board .....	24
bus Video access gate .....	26
courseware – House intercom system in bus technology .....	29
<b>Classic call systems – 2-wire Technology</b>	
classic call systems.....	32
courseware – c all systems .....	37
<b>Bus-capable call systems - Communication Center</b>	
bus Video access gate .....	40
iP telefon Video .....	44
courseware – information technology and V oiP .....	46
<b>BuildingSystemsTrainer®</b>	
bst communications technologies i.....	48
courseware – building communication.....	50
bst communications technologies ii.....	52
courseware – antenna technology .....	54
<b>Fiber optic technology</b>	
Fiber optic connector assembly .....	56
<b>Information and Consulting</b>	
stay connected.....	58
didactic solution from ets .....	60
Quality is the measure of all success.....	62
Please contact us .....	64
your enquiry .....	67





# PeoPle and tecHnology – a PeRFect matchH

technology to inspire you: understanding – comprehending – applying

ETS DIDACTIC is your partner for in-house and institutional education and training in the professional fields of electrical engineering and metal technology.

topics such as industry 4.0, electrical engineering, power electronics, pneumatics, drive technology, automation technology, sensor technology, bus systems, mechatronics, transmission technology and the complete scope of building systems engineering including renewable energies are presented as a training system. With the help of well thought-out learning-oriented hardware and accompanying courseware, the specialist skills are quickly learned, grasped by hands and lead to didactic learning success in a goal-oriented manner.

the service spectrum of ETS DIDACTIC ranges from the provision of didactic hardware, courseware and software to the planning and equipping of the complete training rooms. ets meets all requirements with practice-oriented workshops on the complete spectrum of technical professions for lecturers, trainers and instructors in a specially built modern training center or online.

Vocational schools, training centres of the icc, chamber of crafts or the industry, polytechnics and universities are among the long-standing customers of ETS DIDACTIC.





## Welcome to ets didactic

ETS DIDACTIC is the pioneer and market leader in the development, manufacture and sales of electrical, automation and mechatronic workstations for training and instruction.

ETS DIDACTIC counts among the leading international manufacturers in the market environment. Located in Kinding, in the beautiful natural reserve of altmühltal – high-quality products and solutions are developed and manufactured for you.

In the training centre in Kinding, the focus is on the practical application of the systems and fast learning of new technologies by the customers.

The knowledge, experience and the above-average personal involvement of the motivated employees of ETS DIDACTIC are vital factors for the company's efficiency.



Sven Urban  
Managing Director



Udo Urban  
Managing Director  
(Founder)



# made in geRmany

## Visit ets in the Valley of River altmühl

### Welcome to Germany - Bavaria

the altmühltal nature Park is one of the largest in germany and-of fers a thousand ideas for families, history fans, cultural discoverers and nature lovers.

you can travel to our workshop in Kinding-Haunstetten by train. the regional train station Kinging/altmühlhtal is located directly on the ice route between nuremberg and munich. the regional express trains of deutsche bahn stop every two hours. the journey from Kinding to in golstadt takes 17 minutes, to munich 1 hour 15 minutes and to nu remberg only 27 minutes.

l ocal cab companies are available to take you from Kinding to Haunstet - ten. We will be happy to assist you with the organization.

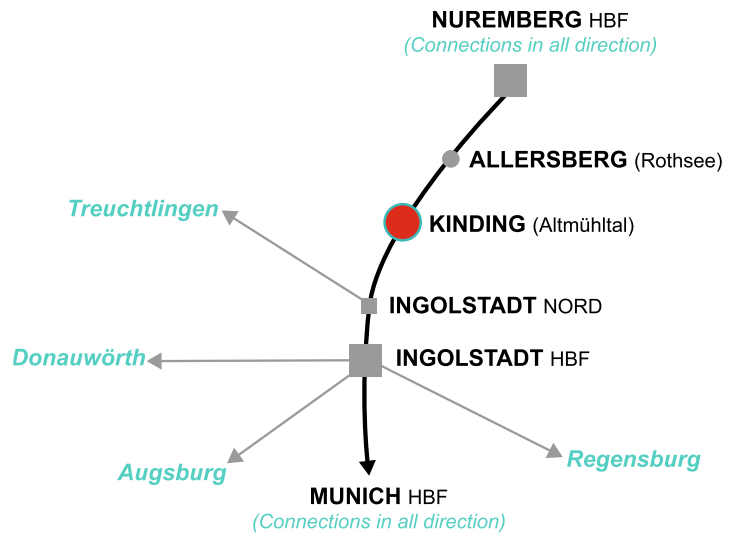



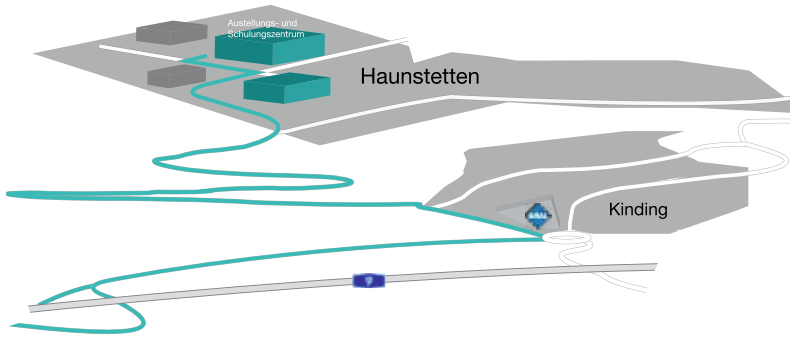

Kloster Weltenburg



naturpark altmühltal

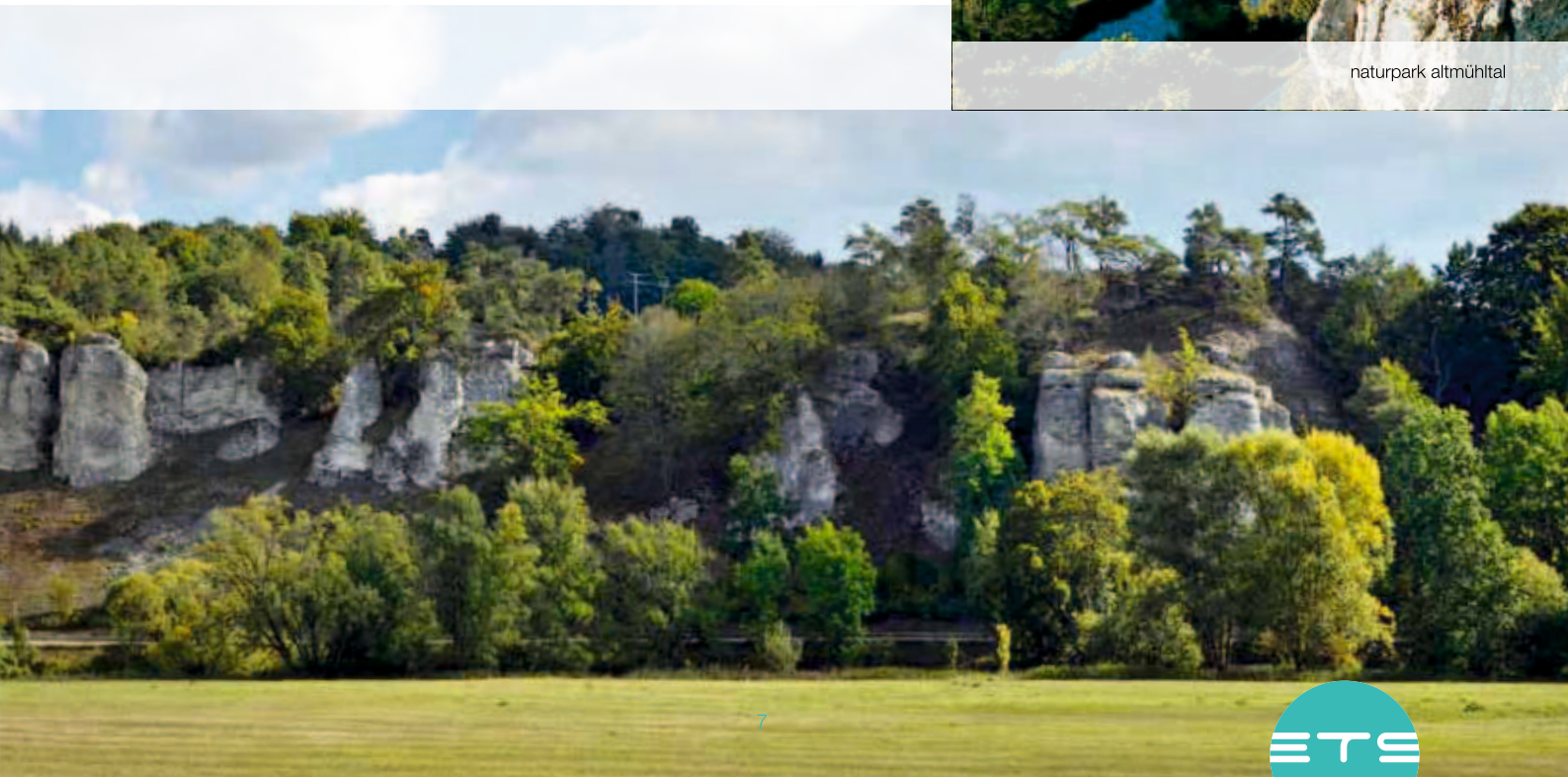



# aPPRoach and Room concePt

to plan a custom-made room concept with you, we proceed in the following steps:

- › a good room concept is based on professional advice. the technical consultants of ets didactic are pleased to support you in the local planning phase. Benefit from their technical expertise and experience.
- › Planning a room concept is more than selecting the furniture. each room concept is adapted to and developed for the local requirements of the customer.
- › taking into account the learning contents an equipment list can be set up. as soon as the extent is defined, the storage equipment is optimised and designed.



analysis

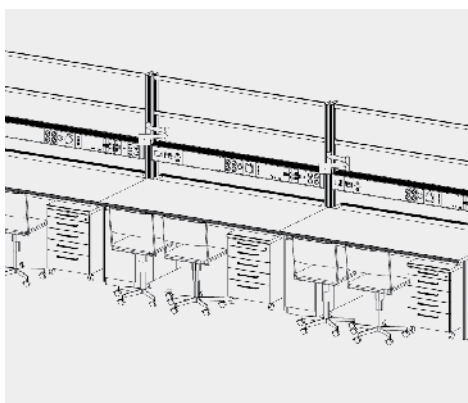

conception



consulation / Planning

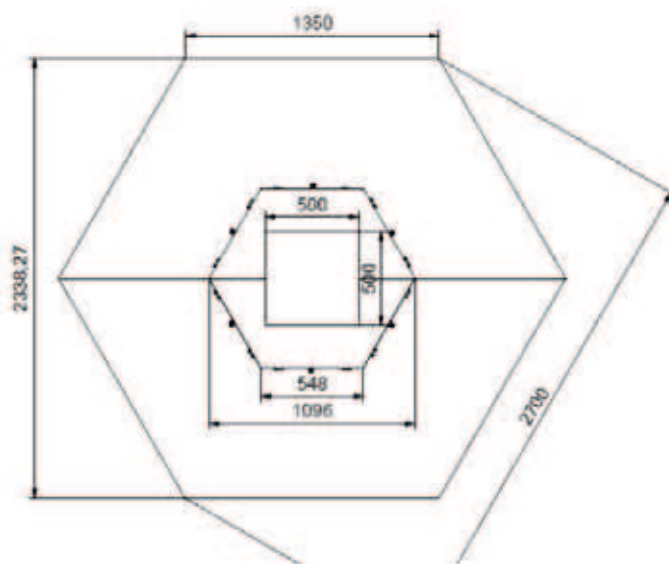



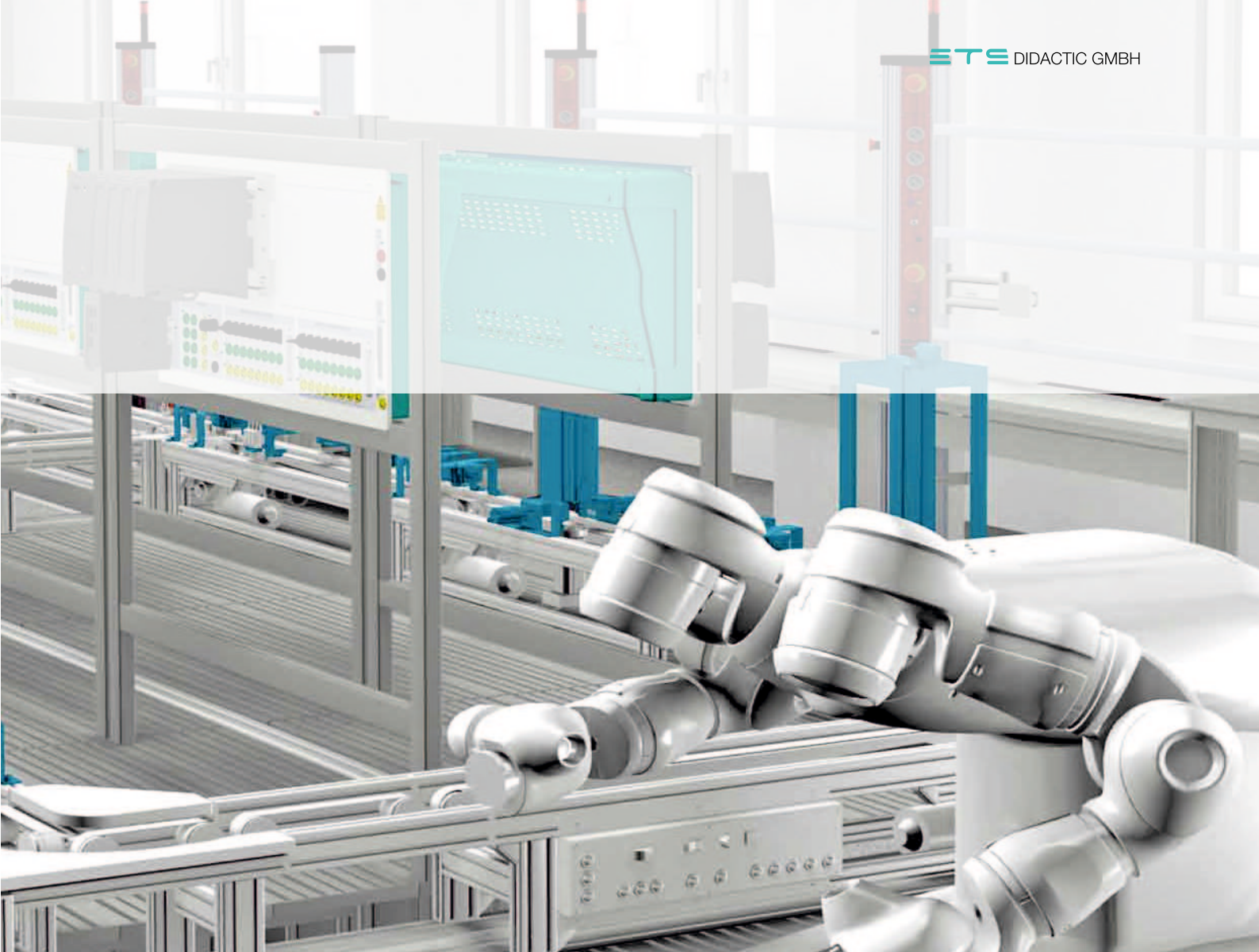

design / construction



Workshops



application





# PeoPle and tecHnology – a PeRFeCt match

didactic and technology Result in the ets-concept



## compact boards

- › their didactical concept makes our training systems in a4 format outstanding.
- › the photorealistic design of their front panels with graphics, pictures, connection details or warning messages assist and guide the experiments - cognitive didactics. due to the graphics, users comprehend and remember the technologies more easily.
- › the systems can be mounted in an a4 frame or placed directly on a table.

## experimental boxes

- › construct your own experiments. beside the wiring, the arrangement of the components is focused. With the experimental boxes it's possible to practice basic circuits as well as complex installations
- › always close to practice, fast and safe!
- › Wide range of industrial components.





## bst<sup>®</sup>-buildingsystemstainer

› the buildingsystemstainer<sup>®</sup> is a mobile training system that can be taken from one classroom to another and then is ready for use within some minutes.

› beside our laboratory equipment with the experimental boards, these flexible training systems represent an independent product line covering many topics as e.g. the Vde protective measures according to Vde 0100 or the KnX building communication sector, communications technology and renewable energies, smartbuilding and internet-of-things.

› boards can also be integrated in the buildingsystemstainer<sup>®</sup>

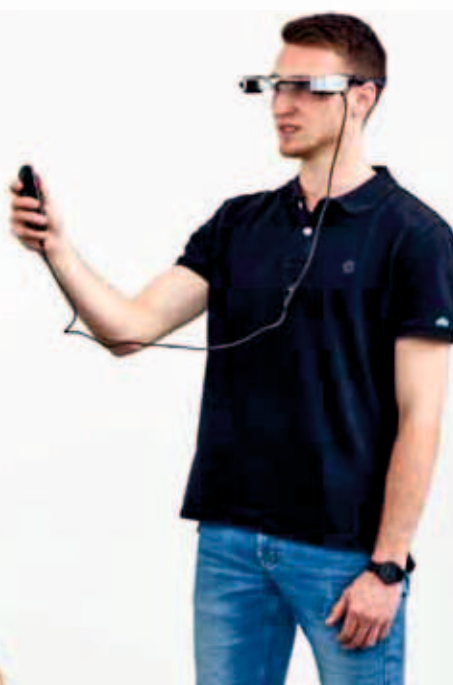
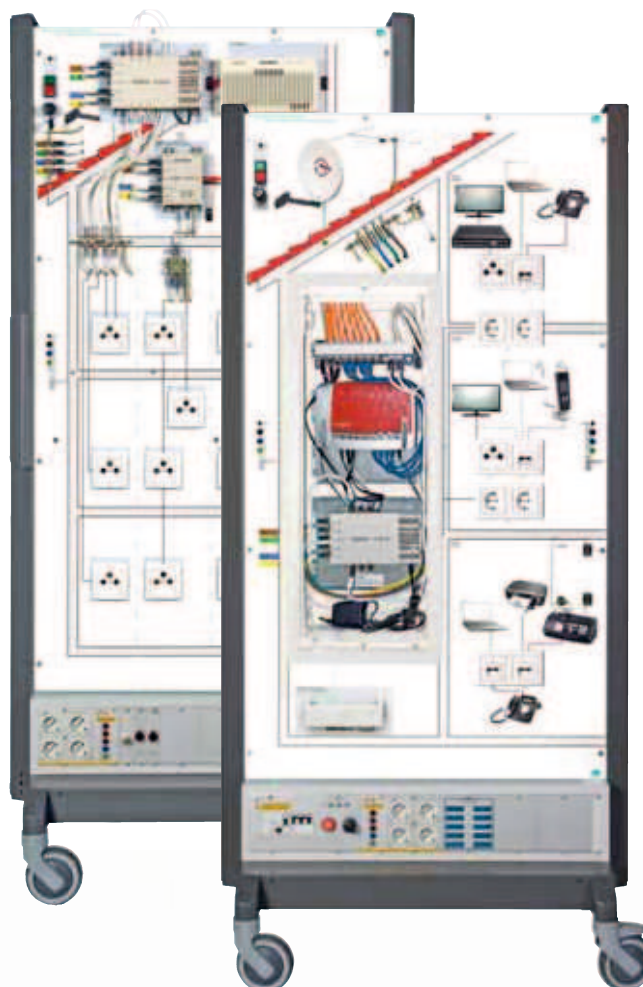

# WoRKsHoPs With ets

always up to date – training at the Highest Level



Train the trainer – workshops for teachers, trainers and lecturers in the field of electrical engineering, mechatronics and metal technology.

Learn more about the management and the application of various technologies with the support of the ets trainers. Find out more about the didactic concept and learn to teach the material quickly and safe.

ETS offers a perfect seminar for all groups of products and topics of technical education. scan the QR code to subscribe in a workshop:



[ets-didactic.de/hp584/Workshops.htm](https://ets-didactic.de/hp584/Workshops.htm)





Fast and safe into new technologies

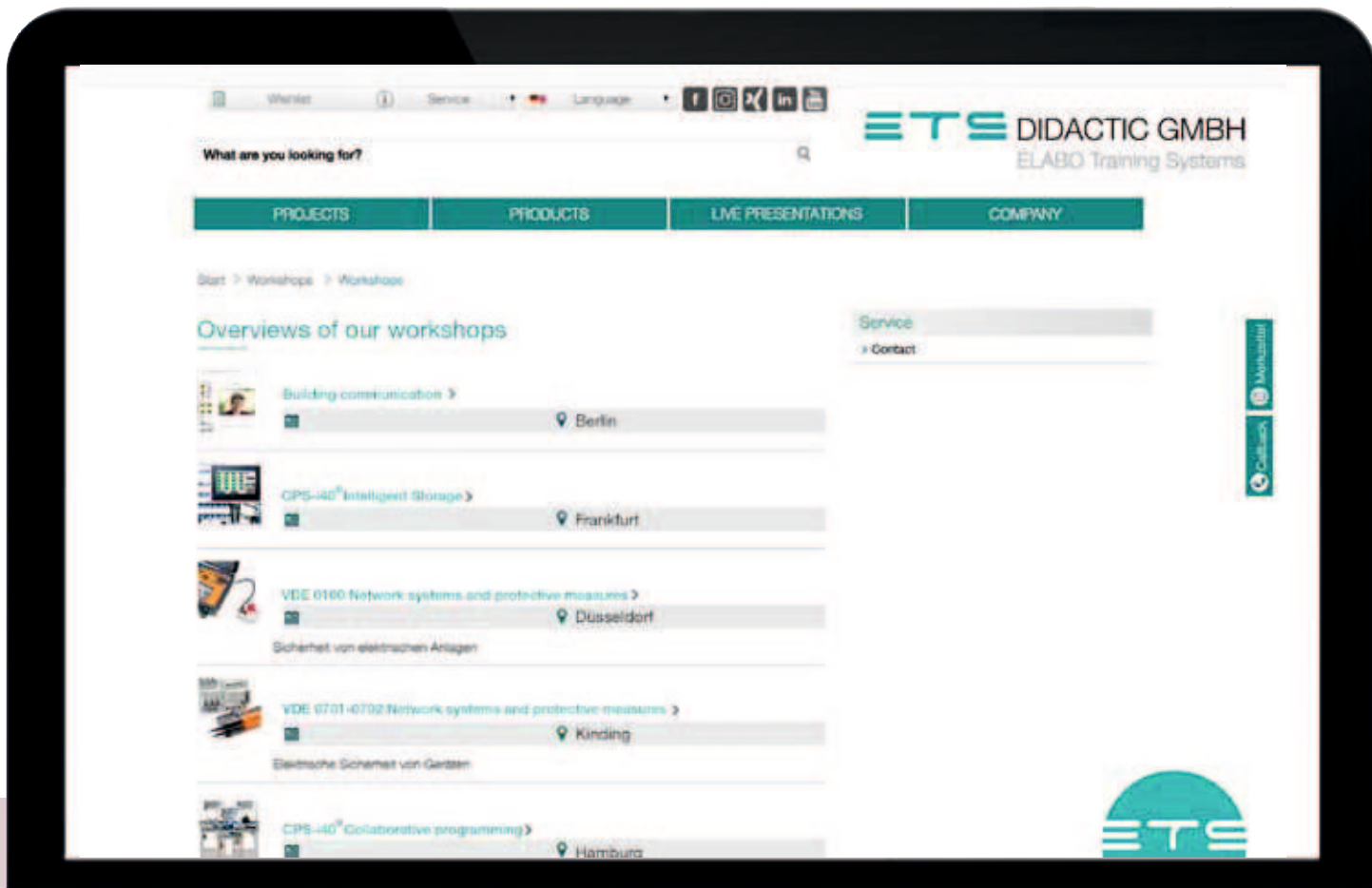



# WORKSHOPS WITH ets

always up to date – training at the Highest Level

- structure of the manuals
- › Ringbinder principle
  - › dividers
  - › incorporation of personal documents



compact

- techNoCards®
- › depiction of the parameters in function groups
  - › start-up instructions
  - › safety functions
  - › individual learning help

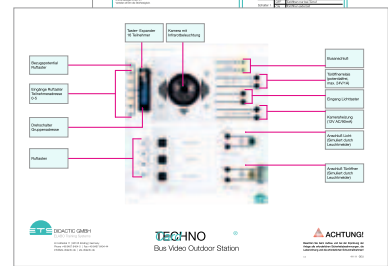
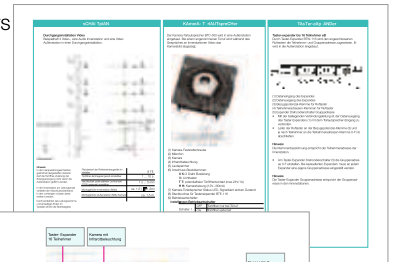

close to practice

- simulations software
- › accompanying the courseware
  - › Function simulation
  - › combination of theory and practice



motivating



multimedia

- Front panel overlays
- › contents reduced to main focus of the experiment
  - › clear layout
  - › basic function
  - › Various languages

- Furniture
- › technically matched conception
  - › excellent functionality
  - › ergonomics at the workplace
  - › outstanding design

efficient



ergonomics



... the system to building communication

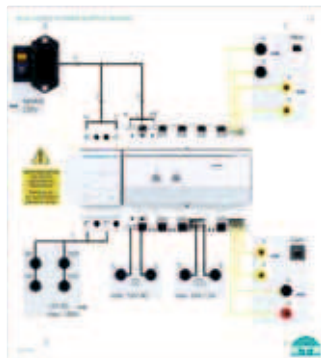

- › latest technology
- › easy to operate
- › didactically prepared teachware
- › safety for human and machine
- › ergonomically perfect workstation





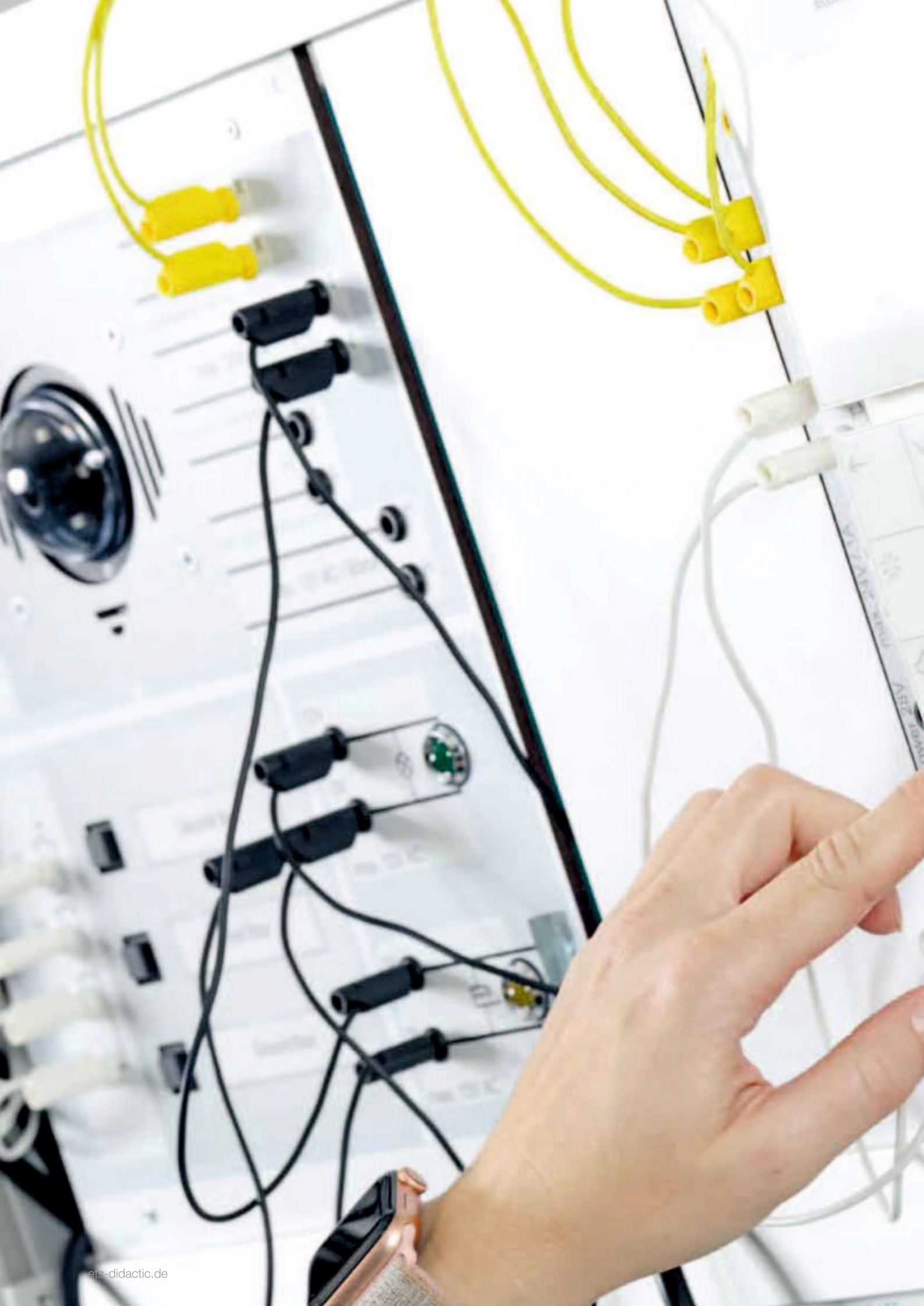

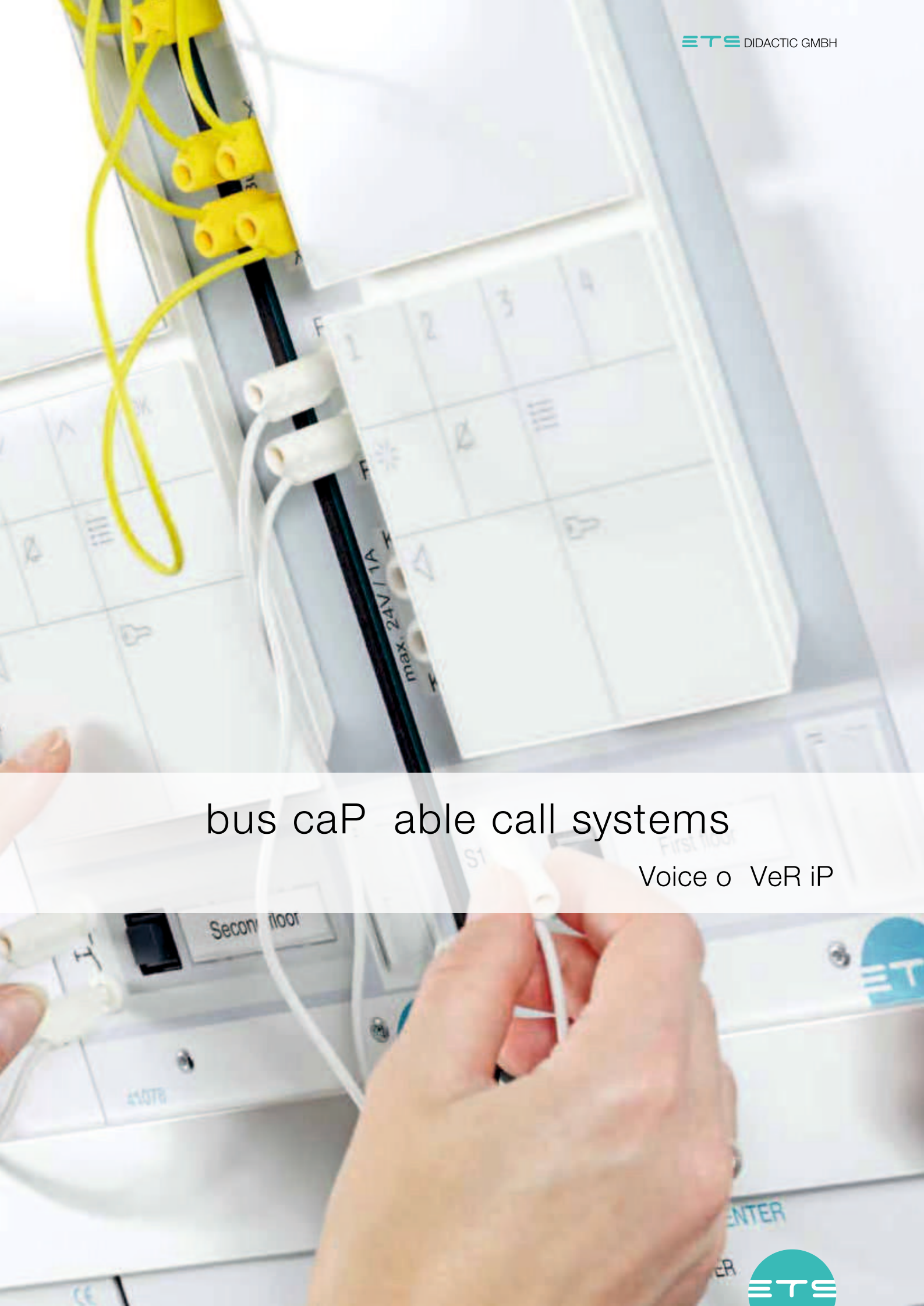

# bus caP able call systems

Voice o Ver iP



# audio Residential station

## Hardware



### Learning objectives

- › Configuration and programming of an audio intercom
- › Configuration and commissioning of a house intercom system in bus technology
- › Programming of an internal speech connection

### Audio Indoor station in DIN A4 system, consisting of:

- › comfort audio home station in bus technology with four additional button
- › door opener and light button
- › Floor call button
- › internal voice communication possible

### Technical data

- › operating voltage from system bus
- › terminating resistor for system bus

1



# Video Residential station

## Hardware



2

### Learning objectives

- › commissioning of various system functions such as door opener, light control, floor call
- › Configuration and programming of a video intercom system
- › extension of an audio intercom system into a video intercom system

### Video indoor station in DIN A4-System, consisting of:

- › comfort video indoor station in bus technology with color monitor
- › door opener and light button
- › Floor call button
- › internal voice communication possible

### Technical data

- › operating voltage from system bus
- › terminating resistor for system bus

No.	Designation	Order No.
1	bus audio indoor station	41077
2	bus video indoor station	41078



# Video door station

## Hardware



1

### Learning objectives

- › installation and commissioning of a house intercom system in bus technology
- › integration of a video camera
- › Programming of various system functions such as two door stations, parallel call to two subscribers, control of light and door opener
- › determination of the installation location of a video front-door station

### Video outdoor station in DIN A4-System, consisting of:

- › bus push-button expander 16-fold
- › bus door loudspeaker with light button
- › indicator lamps for the door release and light control functions
- › bus color camera module

### Technical data

- › operating voltage from the system bus
- › operating voltage of the indicator lights 12 V ac

No.	Designation	Order No.
1	Video outdoor station	41075

# call systems today

## Function

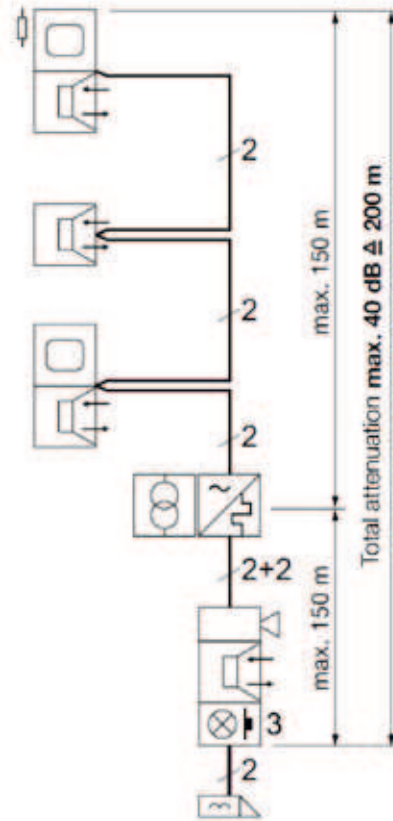
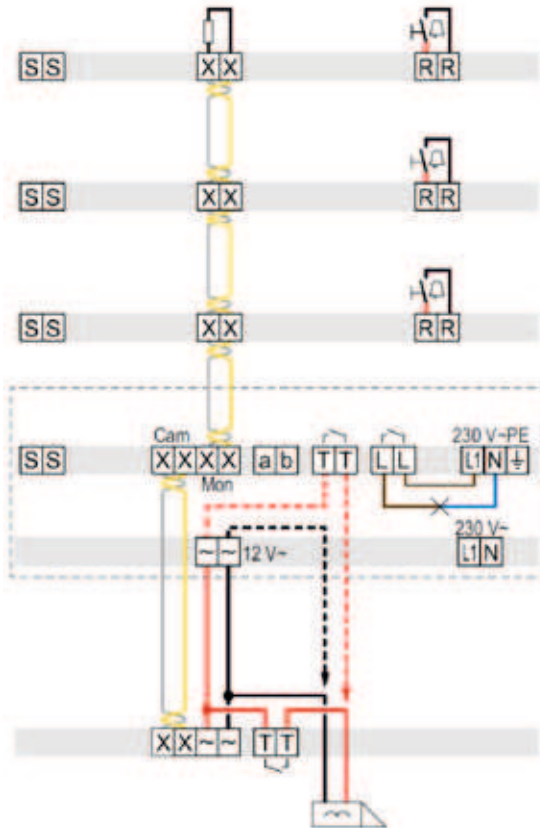





L N L PE

SS AX Max

ELCOM.

Power

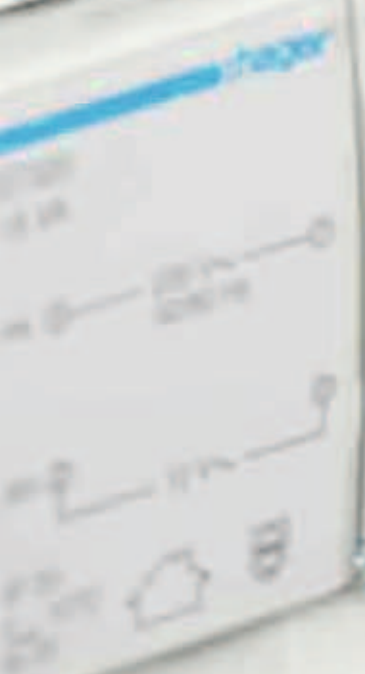

max 250V/16A

max 250V/16A

SS AX

X

X



# bus-caP able bus systems

bus Video a ccess gate

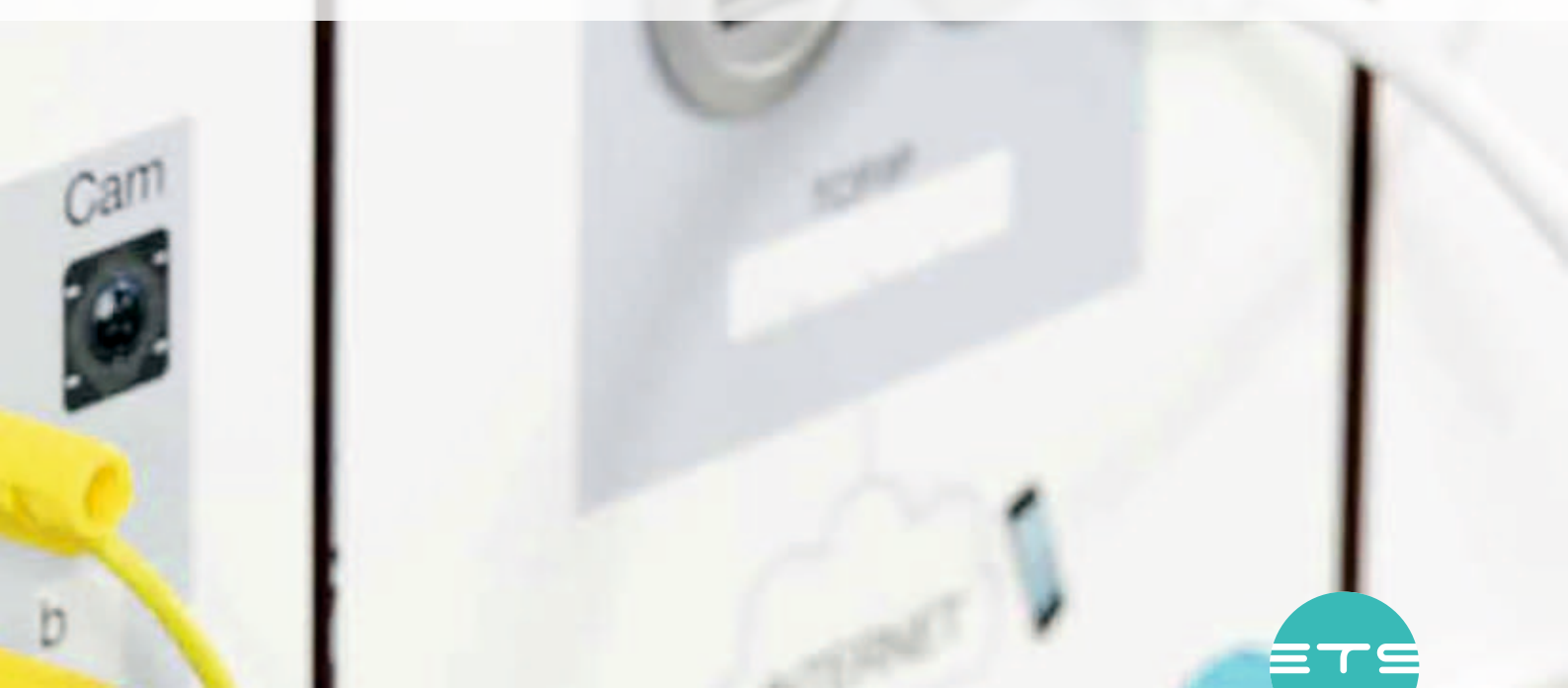



# Video PoWeR suPPly boaRd

## Hardware

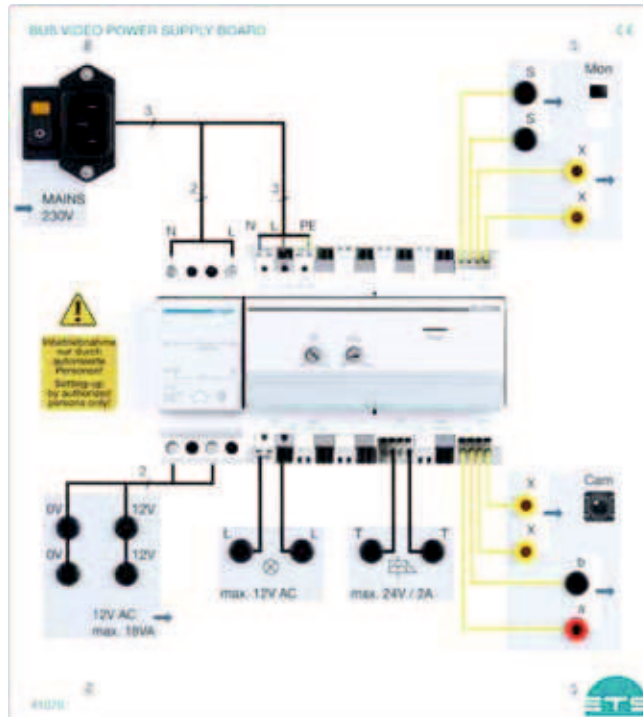

1

### Learning objectives

- Project planning and installation of a house intercom system in bus technology

### Video Power Supply Board in DIN A4-System, consisting of:

- Power supply unit 12 V ac for supply of the devices
- bus video control unit for supply of the bus participants

### Technical data

- operating voltage 230 V
- output voltage 12 V ac; 1,3 a
- output voltage system bus
- door opener relay
- light relay

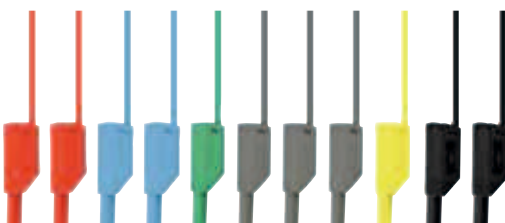

2

No.	Designation	Order No.
1	Video Power supply board	41076
2	2 mm safety measuring cable set	90005

# installation through topology



# star topology

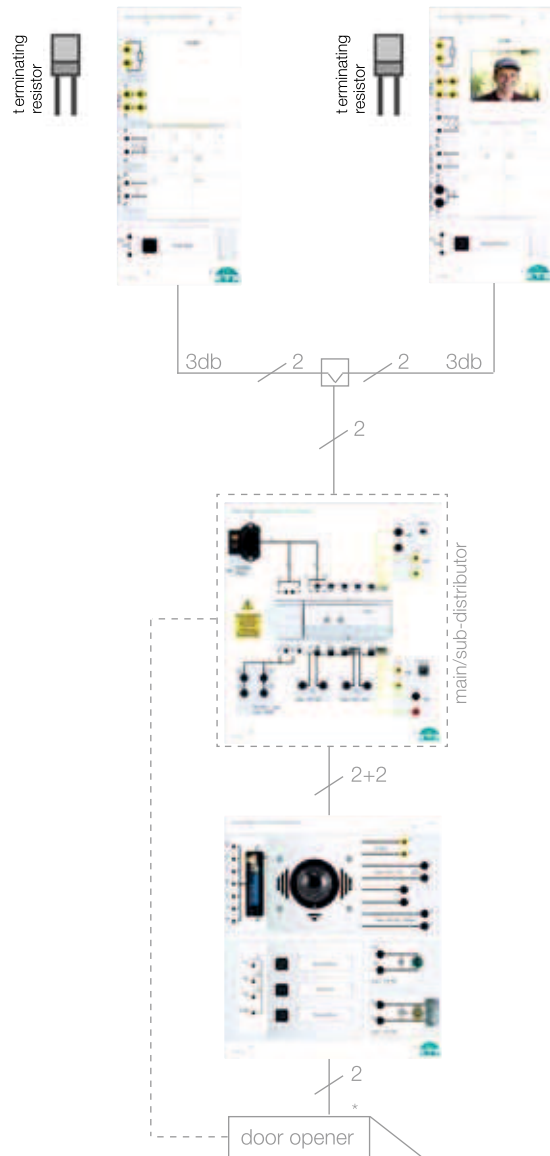

\*) connection of the door release either  
 - in the distributor at the integrated relay of the new bus line supply or  
 - at the integrated relay of the front-door station



# bus Video access gate

## Hardware

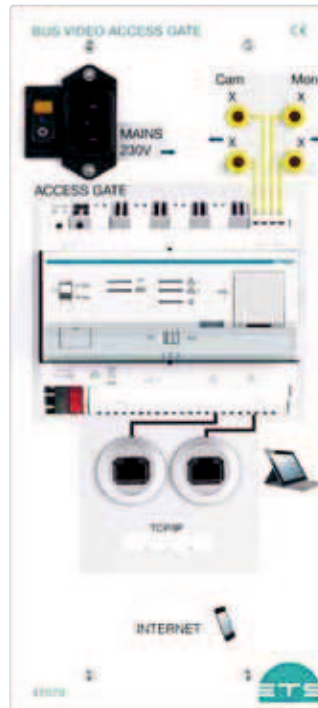

1

### Learning objectives

- › commissioning and programming of the access gate
- › Forwarding door calls to smartphone
- › set up image storage
- › Realize cloud creation
- › set up corresponding end devices (ios/android)

### Access gate in DIN A4

#### System, consisting of:

- › access gate 2 wire to iP
- › Power supply 24 V dc
- › connection for 2 wire bus
- › 2xRJ45 network connection integrated switch

### Technical data

- › operating voltage 230 V ac
- › bus connection camera branch
- › bus connection monitor branch
- › 2xRJ45 network connection
- › cloud connection possible

No.	Designation	Order No.
1	bus Video access gate	41079

# access gate

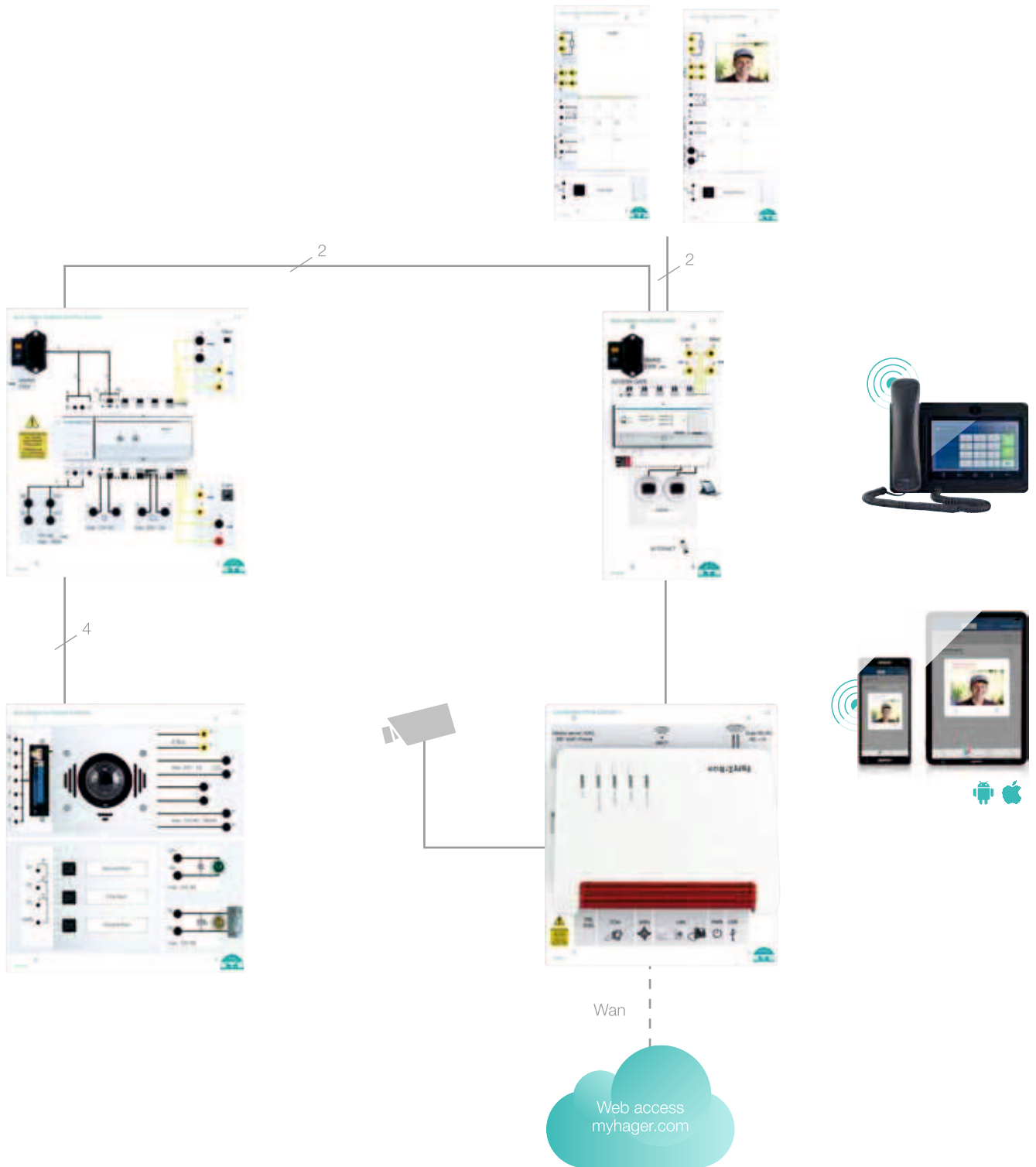

# House inteRcom systems in bus technology

## courseware



Printed and digital

1



2

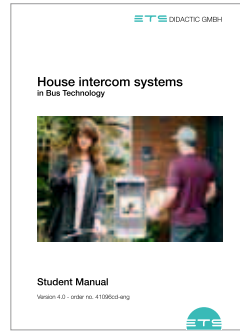

3

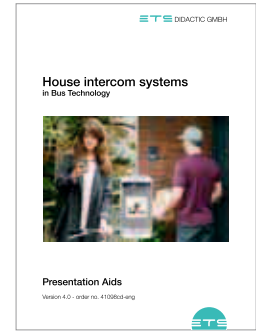

4

### Manual content

- › Project 1  
Retrofitting of an intercom system
- › Project 2  
Video extension of an intercom system
- › Project 3  
network – connection of video intercom system

No.	Designation	Order No.
1	set of ets ring binders	91903
2	IF 9: bus-compatible house intercom systems - instructor's manual	41095cd-eng
3	IF 9: bus-compatible house intercom systems - student manual	41096cd-eng
4	IF 9: bus-compatible house intercom systems - Presentation aids	41098cd-eng



TECHNOCard®

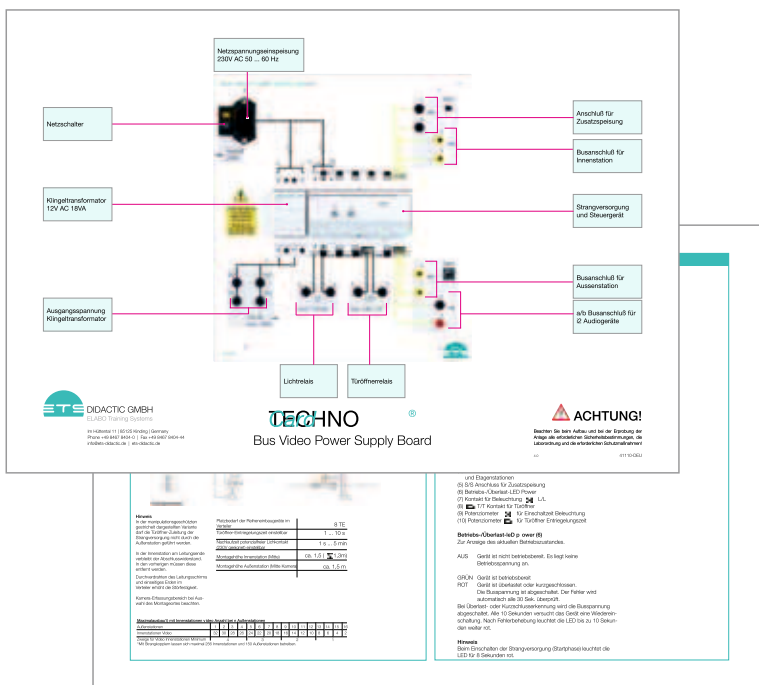

the techNoc ards® are a practical supplement to the training system. on them, the trainee finds a kind of knowledge store in concentrated, clear form for constant reference during practical work.

- display board in 303 mm x 426 mm format
- double-sided color design
- Robust, hard-wearing quality

1

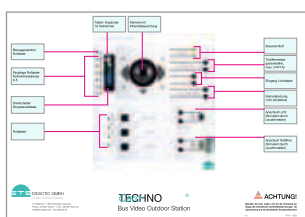

2

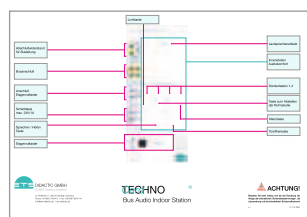

3

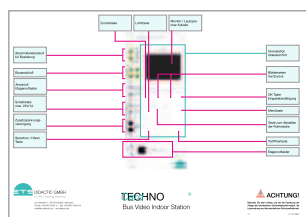

4

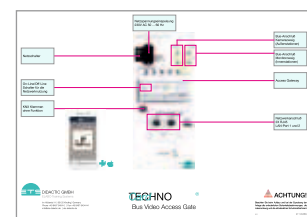

5

No.	Designation	Order No.
1	techNoc ard® - bus Video Power supply board	41110-eng
2	techNoc ard® - bus Video outdoor s tation	41111-eng
3	techNoc ard® - bus audio indoor s tation	41112-eng
4	techNoc ard® - bus Video indoor s tation	41113-eng
5	techNoc ard® - bus Video access gate	41114-eng









# classic call systems

2-WiRe technology



# classic call systems

## intercom main system

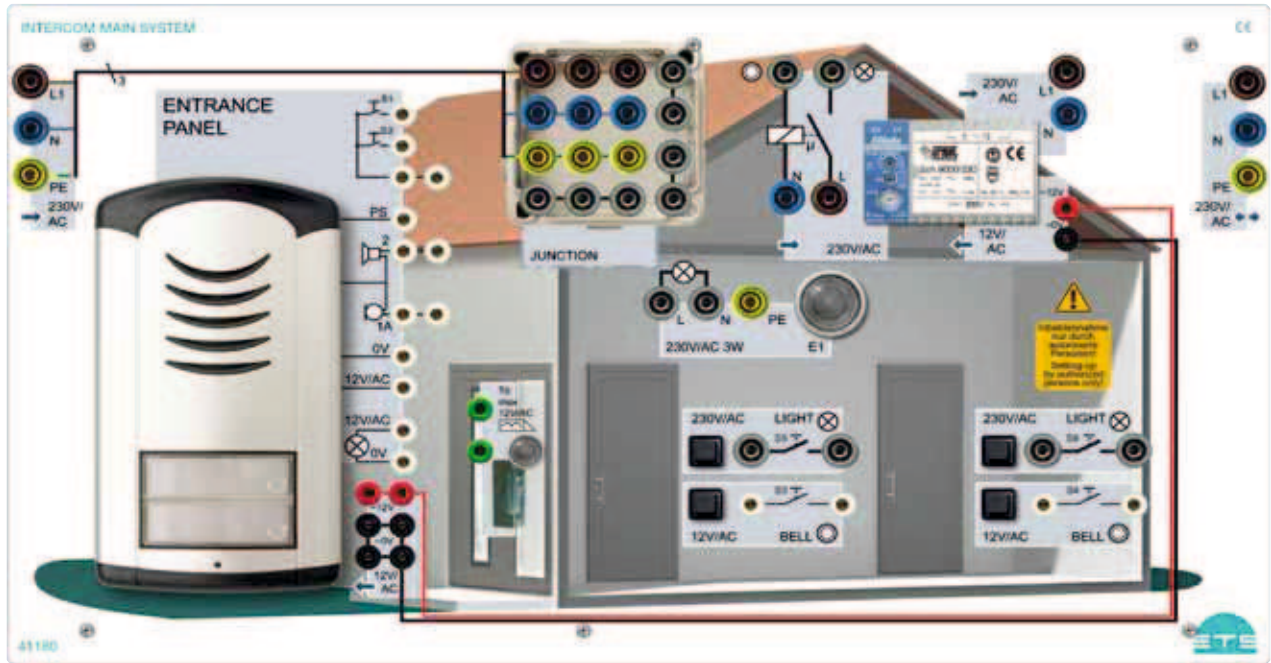

1

### Learning objectives

- › Planning, setting up and commissioning circuits of intercom and signaling systems
- › Parallel connection of intercom and signaling systems for several residential units
- › automation of staircase lighting via an automatic staircase lighting system
- › troubleshooting in a house intercom and signaling system

### Technical data

- › surface-mounted housing with two call buttons and switchable button illumination, loudspeaker and microphone module
- › staircase lighting controller with current impulse function and the options off-delay and switch-off pre-warning
- › additional two call buttons and two buttons for staircase lighting control in a visually separated corridor
- › door opener in 12 V/ac version at a graphically displayed house access door
- › staircase lighting in 230 V/ac version and Pe connection
- › bell transformer 230V/ac to 12V/ac
- › distribution box with taps for 230 V/ac supply and additional free terminals - color separated designed as 4mm safety sockets
- › the connections of the components operated with 230 V are designed as 4mm safety sockets
- › the connections of the house intercom system are designed as 2mm safety sockets

No.	Designation	Order No.
1	intercom main system	41180



# classic call systems

## intercom sub s system



1

### Learning objectives

- › Planning, setting up and commissioning circuits of intercom and signaling systems
- › Parallel connection of intercom and signaling systems for several residential units
- › automation of staircase lighting via an automatic staircase lighting system
- › troubleshooting in a house intercom and signaling system

### Technical data

- › surface-mounted housing with handset, integrated loudspeaker and microphone, and door release button with integrated buzzer.
- › additional button for free use
- › operating voltage 12V/ac
- › the connections are designed as 2mm safety sockets

No.	Designation	Order No.
1	intercom sub s system	41181





# call systems

## courseware



Printed and digital

1

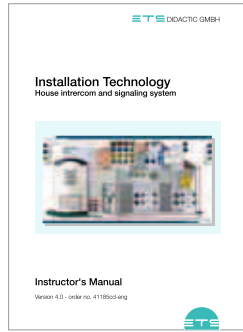

2

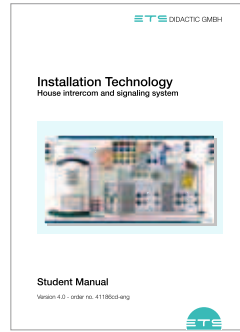

3

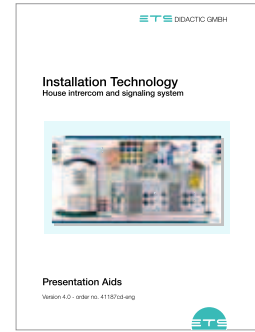

4

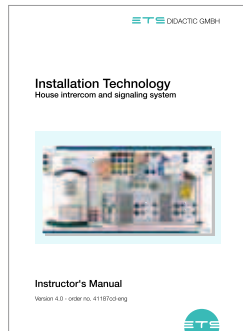

5

### Manual content

- › Project 1  
House intercom with door opener for a family house
- › Project 2  
House intercom with door opener and staircase light control for a single-family house
- › Project 3  
House intercom with door opener and staircase lighting control for a two-family house

### Project structure

- Features
- Practical relevance
- device list
- circuit diagram
- circuit diagram structure
- Questions

No.	Designation	Order No.
1	set of ets ring binders	91903
2	installation technology, house intercom and signaling system - student manual	41185cd-eng
3	installation technology, house intercom and signaling system - instructor's manual	41186cd-eng
4	installation technology, house intercom and signaling system - commissioning and troubleshooting	41187cd-eng
5	installation technology, house intercom and signaling system - Presentation aids	41188cd-eng

TECHNOCard®

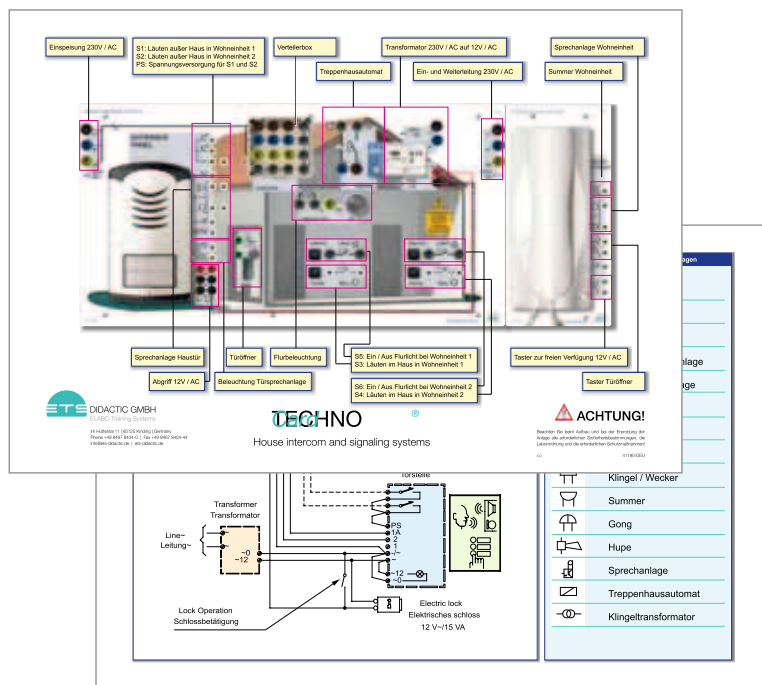

the techNoc ards® are a practical supplement to the training system. on them, the trainee finds a kind of knowledge store in concentrated, clear form for constant reference during practical work.

- › display board in 303 mm x 426 mm format
- › double-sided color design
- › Robust, hard-wearing quality

1

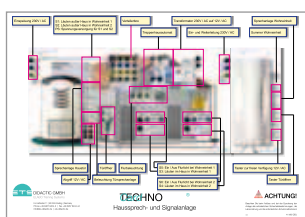

2

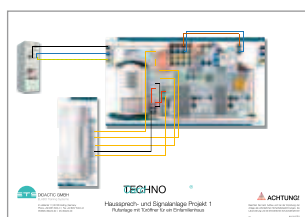

3

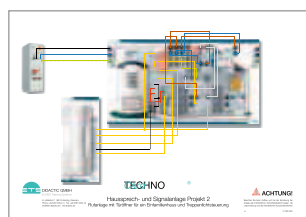

4

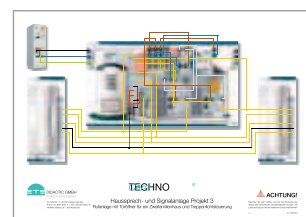

5

No.	Designation	Order No.
1	set of techNoc ards® - House intercom	41189-eng
2	techNoc ard® - House intercom and signaling systems	41190-eng
3	techNoc ard® - House intercom and signaling systems Project 1	41191-eng
4	techNoc ard® - House intercom and signaling systems Project 2	41192-eng
5	techNoc ard® - House intercom and signaling systems Project 3	41193-eng









bus-caP able call systems

communication centeR



# communication center R

## communication center ii

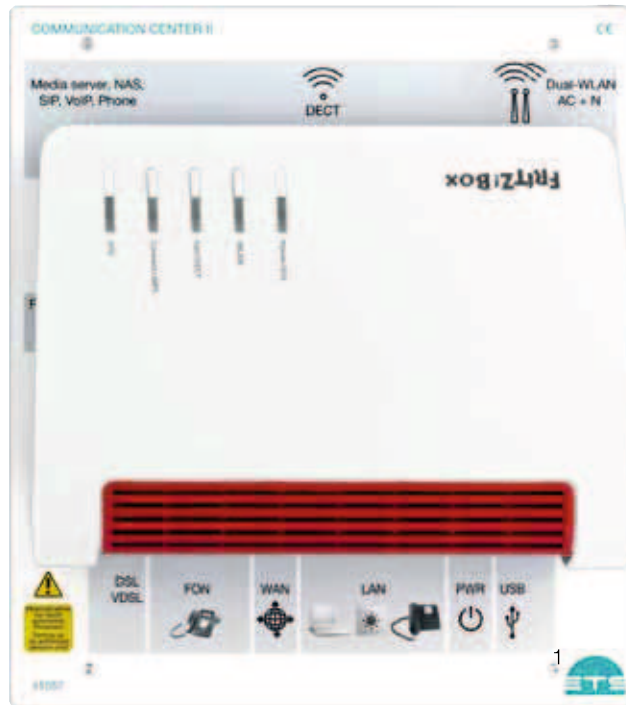

1

### Learning objectives

- } construction and wiring of telecommunication systems
- } Parameterization of telecommunication systems
- } Configuration of IP telephones
- } setup of a private branch system
- } creation of acceptance protocols
- } troubleshooting in systems
- } connection to intercom systems in IP technology
- } setting up iP telephony
- } setting up siP, VoiP telephony
- } setting up it networks (lan/W an/W lan)

### Communication Center II in DIN

#### A4 Syste, consisting of:

- } network router with four port switch and Wlan
- } integrated siP server for 10 subscribers
- } analog private branch exchange (PbX) two port
- } isdn adapter (so interface)
- } dect interface

### Technical data

- } s0 bus
- } dsl connection external
- } Wan connection
- } t wo a/b connections
- } Four ethernet ports RJ45
- } siP server for 10 subscribers
- } dect base station for 6 subscribers
- } integrated answering machine
- } dual Wlan
- } integrated switch, 4x gigabit lan
- } media server

} nas (network attached storage)

- analog telephone connection: RJ12 or tae
- isdn connection: RJ45
- network connection: RJ45

No.	Designation	Order No.
1	communication center ii	41057
2	set of patch cables cat6 - 6 pcs	41056
3	Patch Panel board	41055



# telecommunication VoIP

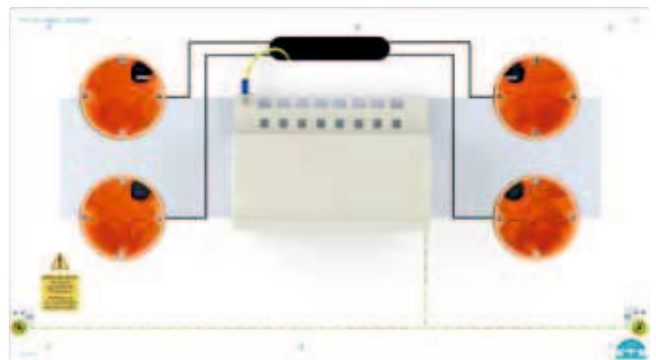
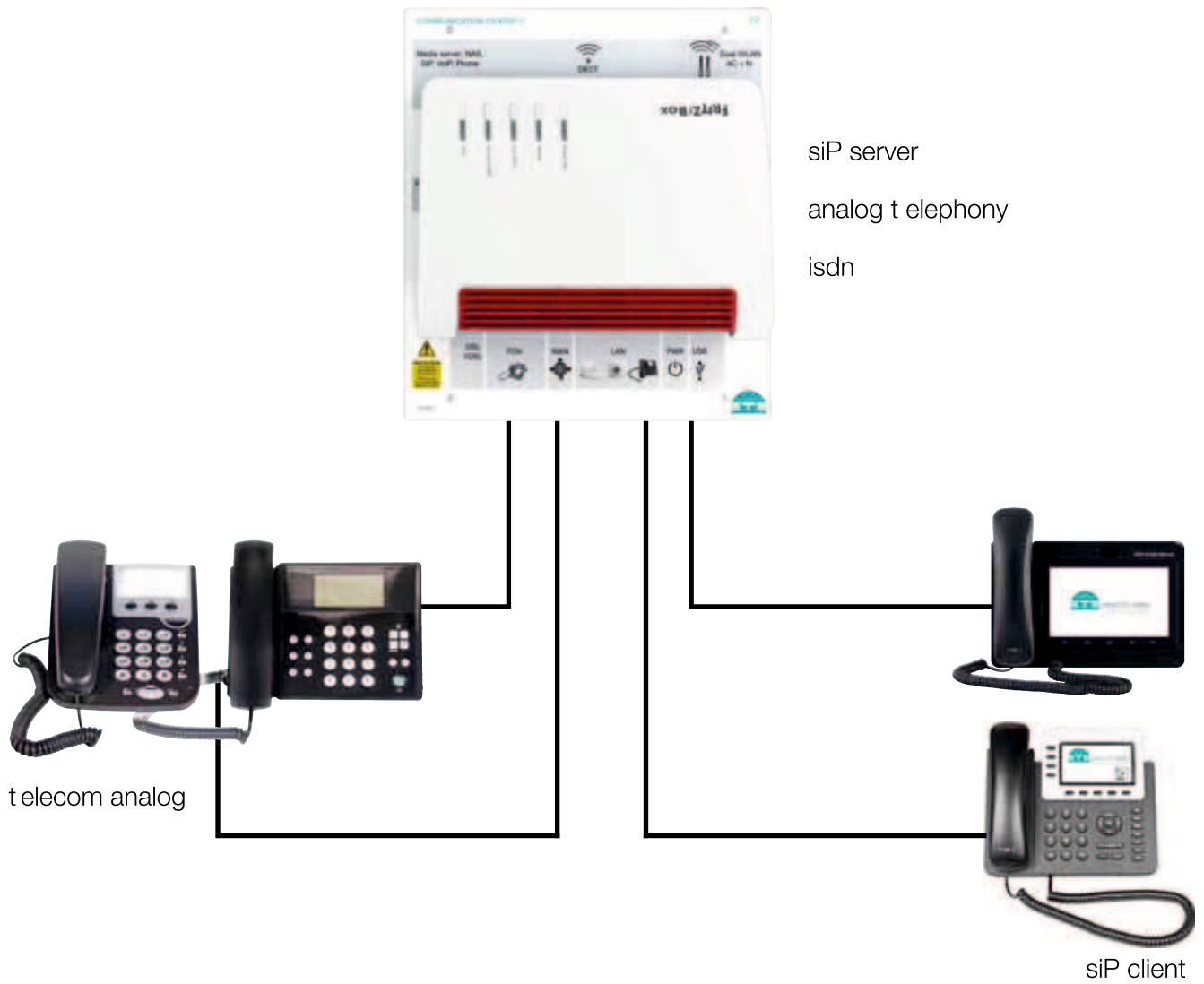



HD



# iP telePHony

Point to Point netWoRK



# iP teleFon Video

## Hardware



1

### Learning objectives

- } setting up network subscribers
- } commissioning VoiP devices
- } setting up Wlan subscribers
- } installation and setup of apps for building communication
- } setting up point-to-point networks
- } setting up video telephony

### Technical data

- } iP phone with android touch panel
- } up to 16 siP accounts / lines
- } Power supply via power supply unit or Poe
- } 7" color touch display
- } auto sensing 10/100/1000mbps
- } Wi-Fi (802.11b/g/n)
- } bluetooth, usb, Hdmi
- } cmos megapixel camera
- } android 7.0 with access to google Playstore

No.	Designation	Order No.
1	iP Phone Video V2	41061

# Point to Point netWoRK

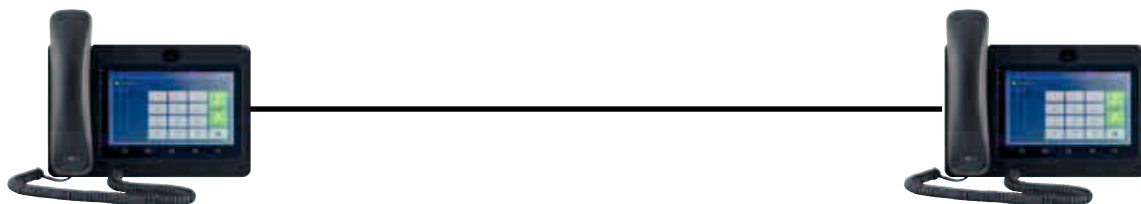

## Point to network



## Wan | lan | Wlan

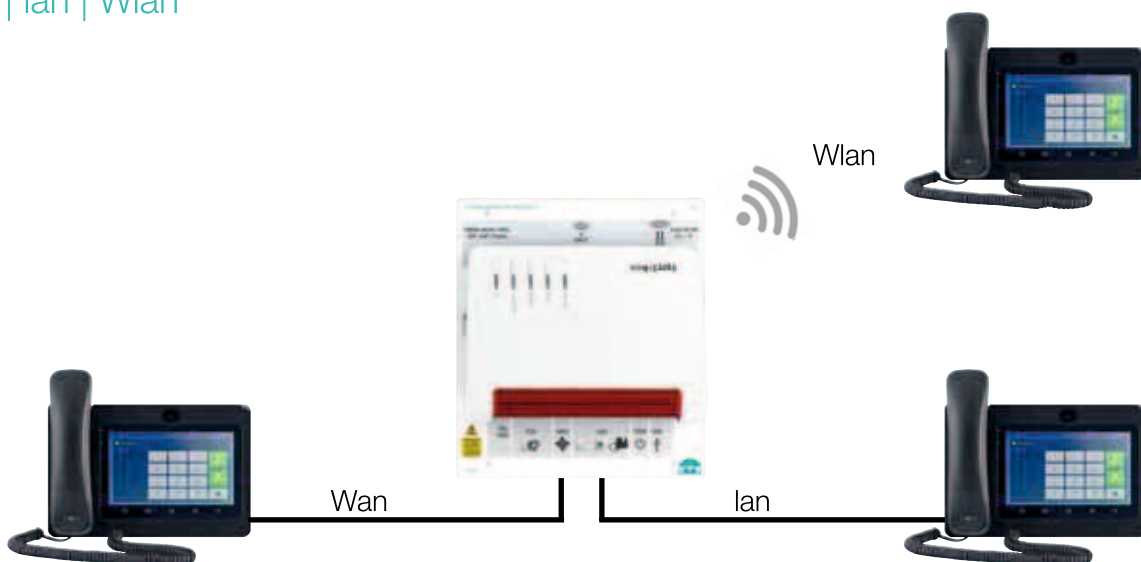

# inFoRmation techNology

## courseware



Printed and digital

1

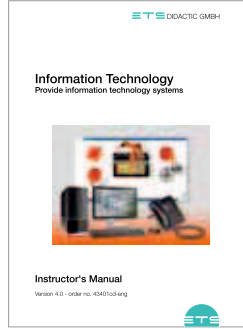

2

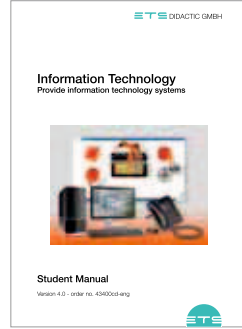

3

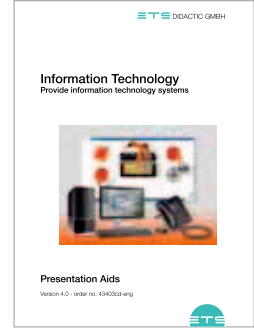

4

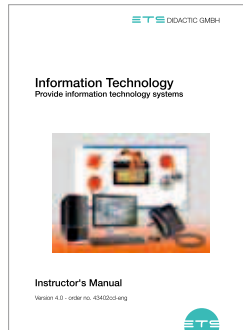

5

### Manual content

- › Project 1  
installation of small networks
- › Project 2  
installation of small networks  
netzwerk
- › Project 3  
installation of small networks

No.	Designation	Order No.
1	set of ets ring binders	91903
2	Provide information systems - student manual	42400cd-eng
3	Provide information systems - instructor's manual	42401cd-eng
4	Provide information systems - commissioning and troubleshooting	42402cd-eng
5	Provide information systems - Presentation aids	42403cd-eng



# Voice over IP (VoIP) courseware



Printed and digital

1

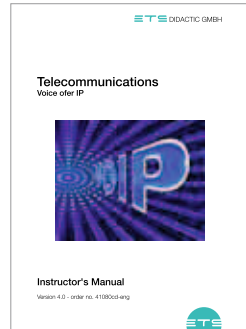

2

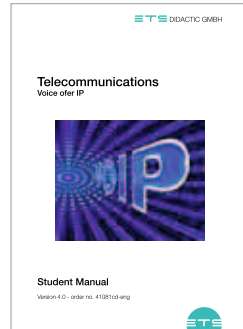

3

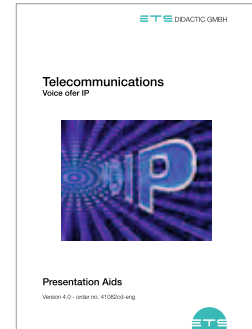

4

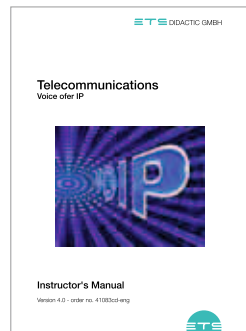

5

## Manual content

- › Project 1  
installation of a telephone and internet connection
- › Project 2  
installation of an iP-based telephone connection
- › Project 3  
extension of an iP-based telephone connection

No.	Designation	Order No.
1	set of ets ring binders	91903
2	t elekkommunikations Voice over iP - instructor's manual	41080cd-eng-V2
3	t elekkommunikations Voice over iP - student manual	41081cd-eng-V2
4	tt elekkommunikations Voice over iP - commissioning and troubleshooting	41082cd-eng-V2
5	t elekkommunikations Voice over iP - Presentation aids	41083cd-eng-V2

# building communications

bst<sup>®</sup> communications technologies

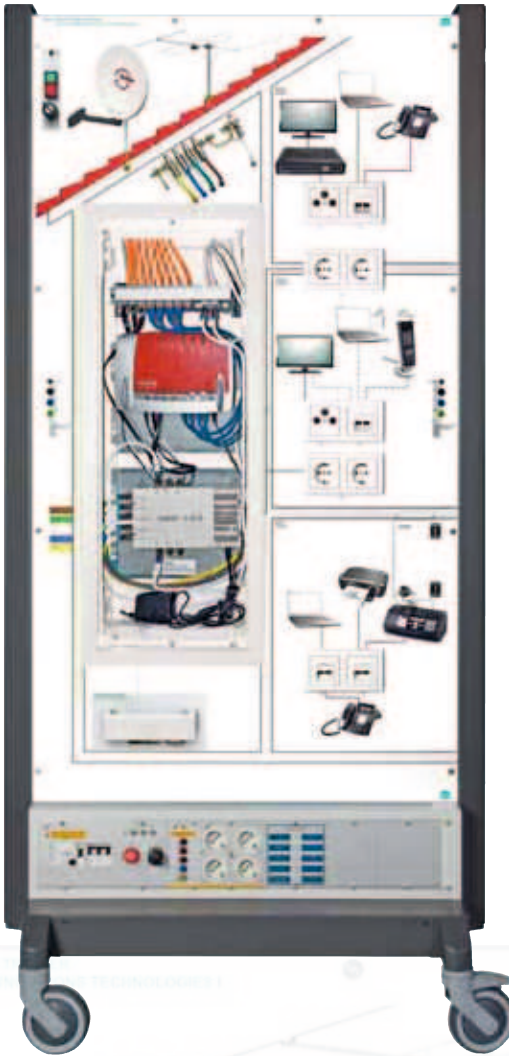

**Learning objectives**

- › Realizing technical building installations according to customer requirements
- › inspect and test technical building systems
- › getting to know networked IT systems
- › installing devices and systems, connecting them to existing networks and modifying them
- › troubleshooting building technology systems

**The system consists of:**

- › connection for dVb-s antenna with universal Quad Inb
- › 8-way patch field RJ45
- › FRitZ!box (2x analog connections, 1x isdn, 4x lan, W-lan)
- › multiswitch for dVb-t and dVb-signal for up to 6 end-devices
- › Fault simulator for telecommunication, network and antenna cabling. additionally, faults in the potential equalization can be set
- › structured cabling at 7
- › multimedia sub-distributor
- › Four junction boxes RJ45
- › two junction boxes antenna
- › Potential equalization

No.	Designation	Order No.
1	bst <sup>®</sup> communications technologies	43560



accessories for your teamwork in the group

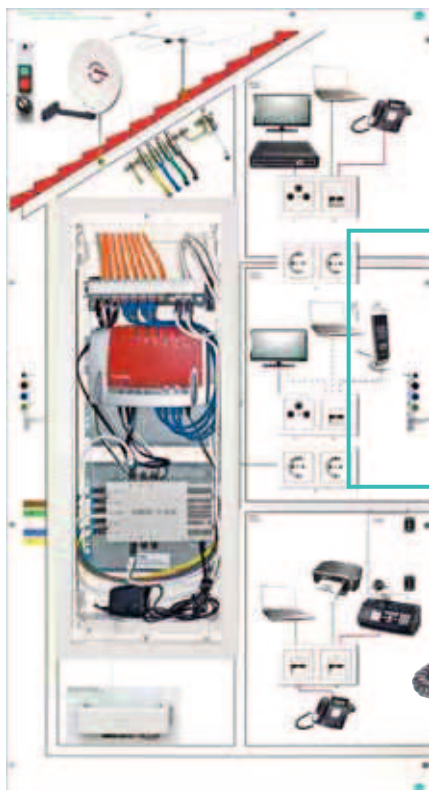

Team 1  
 ) setting up the phones  
 analog / VoiP



iP

1



analog

2

Team 2  
 ) installation of communication lines



3

Team 3  
 ) establishment of structured cabling



4

No.	Designation	Order No.
1	bst ® communications technologies ii	41061-V2
2	measuring receiver	43546
3	network installation set	41070
4	Patch Panel board	41055

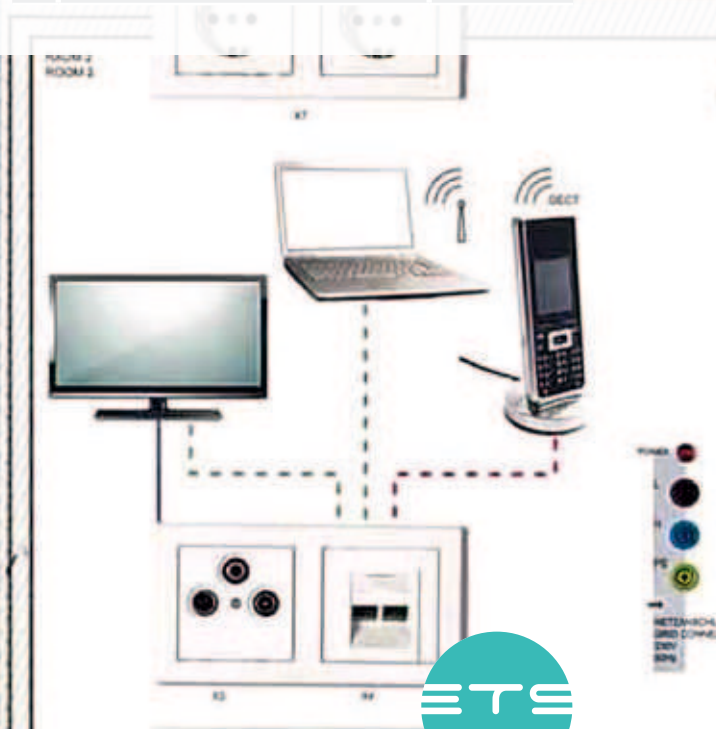
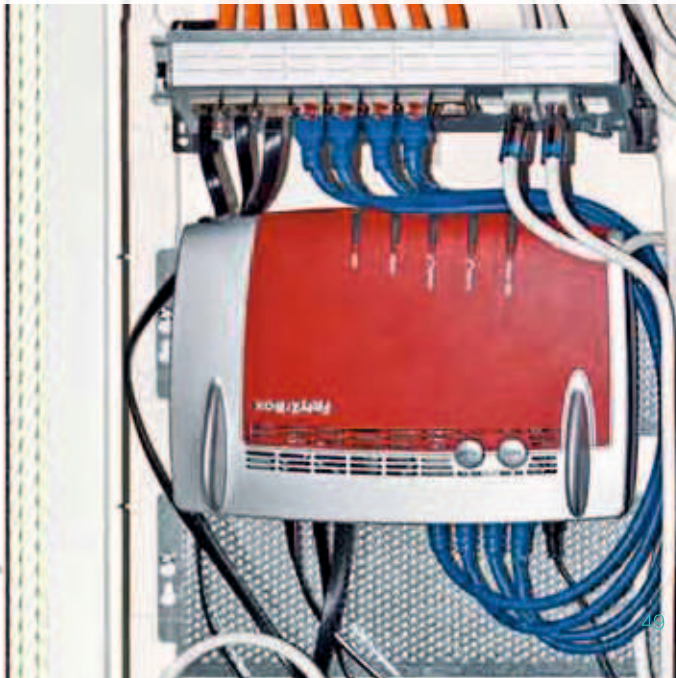



# building communication

## courseware



Printed and digital

1

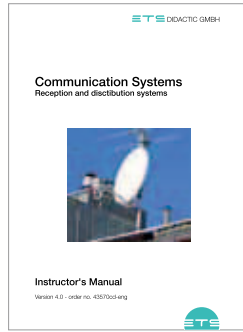

2

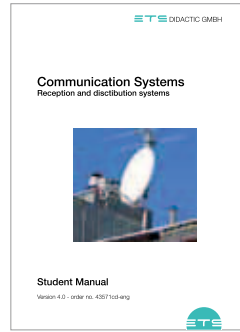

3

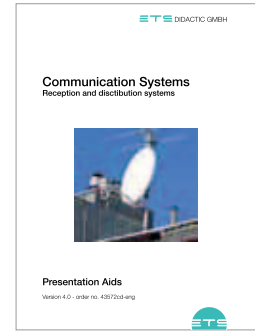

4

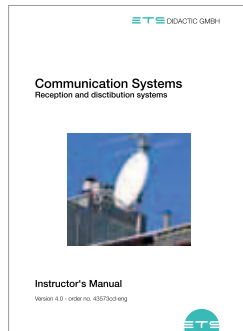

5

### Manual content

- › Project 1  
installation of small satellite reception systems
- › Project 2  
extension of a satellite receiving system
- › Project 3  
construction of a dVb- t reception system

No.	Designation	Order No.
1	set of ets ring binders	91903
2	communication systems - i nstructor's manual	43570cd-eng
3	communication systems - s tudent manual	43571cd-eng
4	c ommunication systems - ommissioning and troubleshooting	43572cd-eng
5	communication systems - Presentation aids	43573cd-eng

TECHNOCard®

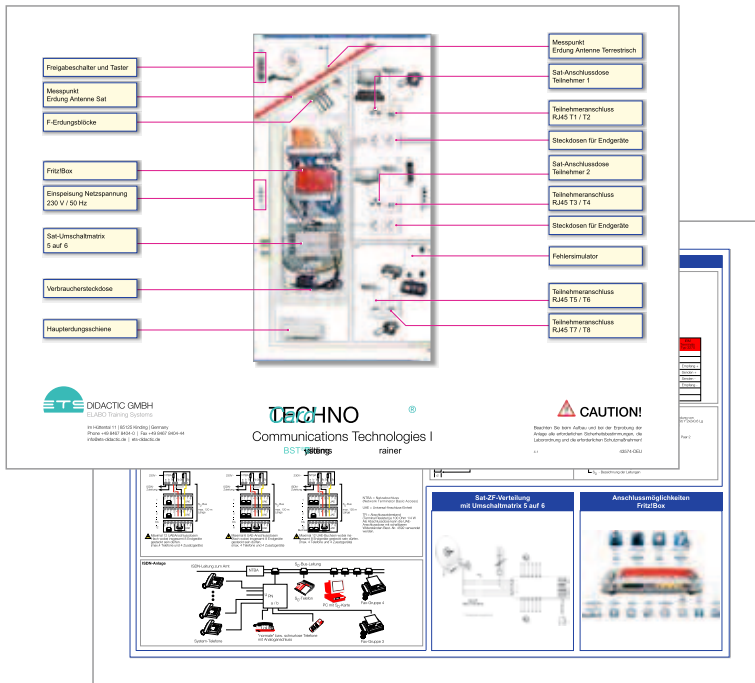

the techNoc ards® are a practical supplement to the training system. on them, the trainee finds a kind of knowledge store in concentrated, clear form for constant reference during practical work.

- › display board in 303 mm x 426 mm format
- › double-sided color design
- › Robust, hard-wearing quality

1

No.	Designation	Order No.
1	techNoc ards® - bst® buildings system rainer communication technologies i	43574-eng

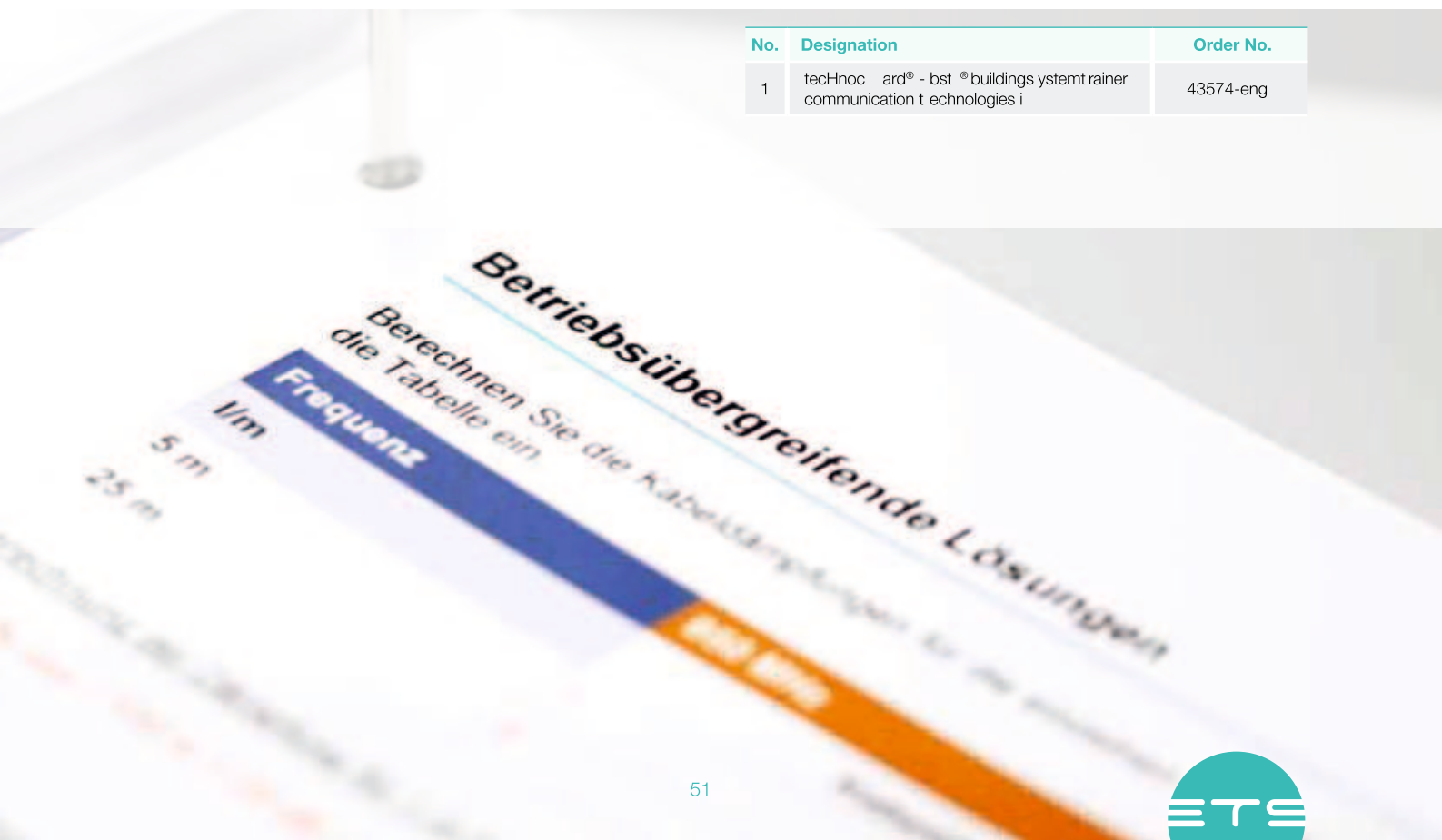

# antenna technology

bst® communications technologies ii

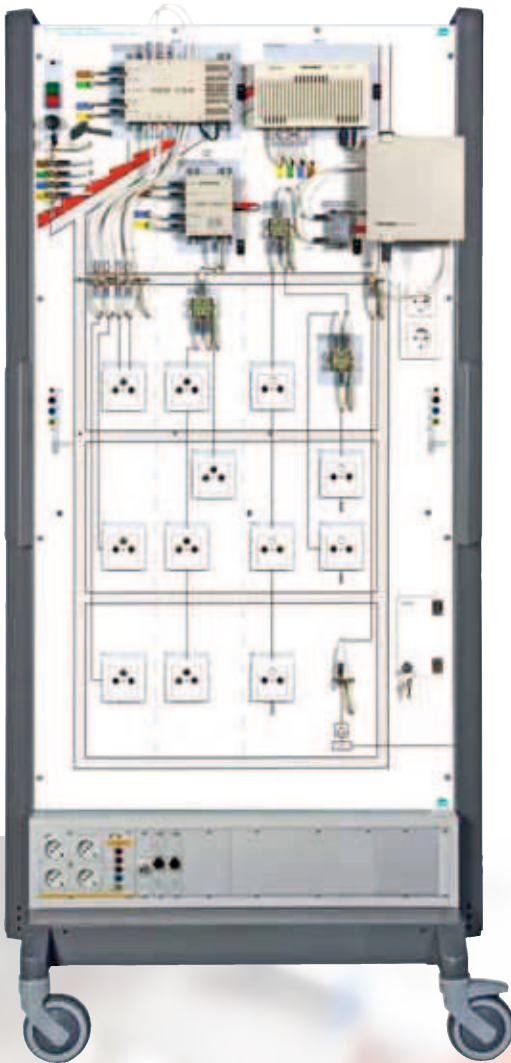

1

**Learning objectives**

- › Realizing technical building installation according to customer requirements
- › inspect and test technical building systems
- › getting to know networked IT systems
- › installing devices and systems, connecting them to existing networks and modifying them
- › troubleshooting building technology systems

**The system consists of:**

- › 1 transfer point for dVb-s signals, without multi-switch (universal Quad Inb) for four outlets
- › three connections sockets for dVb-s
- › single-cable multiswitch 5in/4out
- › three connection sockets for dVb-s scR
- › active dVb-t antenna with remote power supply
- › 1 transfer point for dVb-c
- › Five antenna outlets and line networks for dVb-t and dVb-c
- › antenna splitter and antenna distributor
- › Fault simulator
- › Remote power supply units

No.	Designation	Order No.
1	bst® communications technologies ii	43561



## accessories for your teamwork in the group

### Team 1

) connecting antenna sockets



1



2



### Team 2

) setting up and calibrating a satellite reception system



3



4



5

No.	Designation	Order No.
1	Patch Panel board	41055
2	"coax" tool set	43563
3	measuring receiver	90255
4	signal generator	90251
5	satellite system – digital	43562

# antenna technology

## courseware



Printed and digital

1

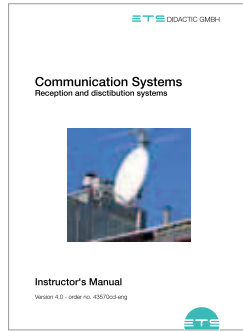

2

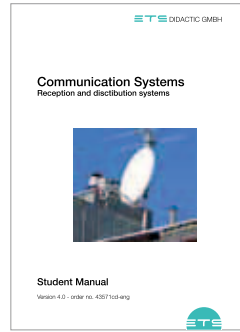

3

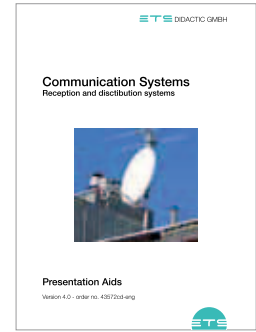

4

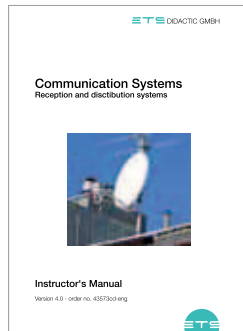

5

### Manual content

- › Project 1  
installation of small satellite reception systems
- › Project 2  
extension of a satellite receiving system
- › Project 3  
construction of a dVb- t reception system

No.	Designation	Order No.
1	set of ets ring binders	91903
2	communication systems - i nstructor's manual	43570cd-eng
3	communication systems - s tudent manual	43571cd-eng
4	c ommunication systems - i nstallation and troubleshooting	43572cd-eng
5	communication systems - Presentation aids	43573cd-eng

TECHNOCard®

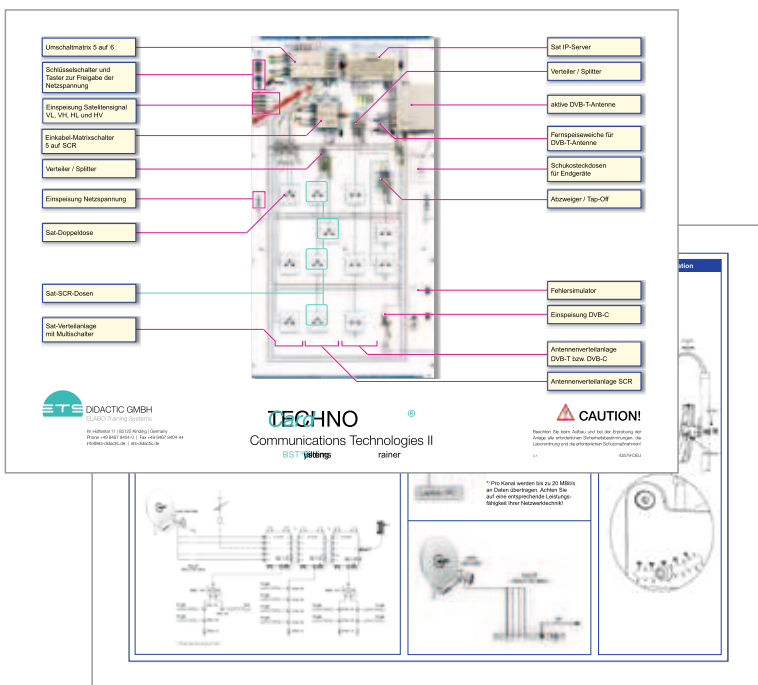

the techNoc ards® are a practical supplement to the training system. on them, the trainee finds a kind of knowledge store in concentrated, clear form for constant reference during practical work.

- > display board in 303 mm x 426 mm format
- > double-sided color design
- > Robust, hard-wearing quality

1

No.	Designation	Order No.
1	techNoc ards® - bst communication technologies ii	43579-eng



# Fiber optic cable

## Fiber optic connector assembly



1

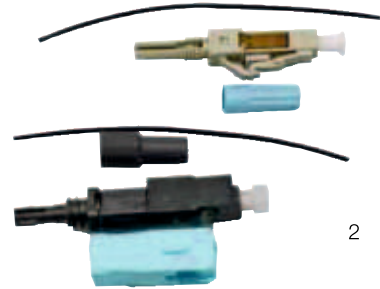

2



3

### structure

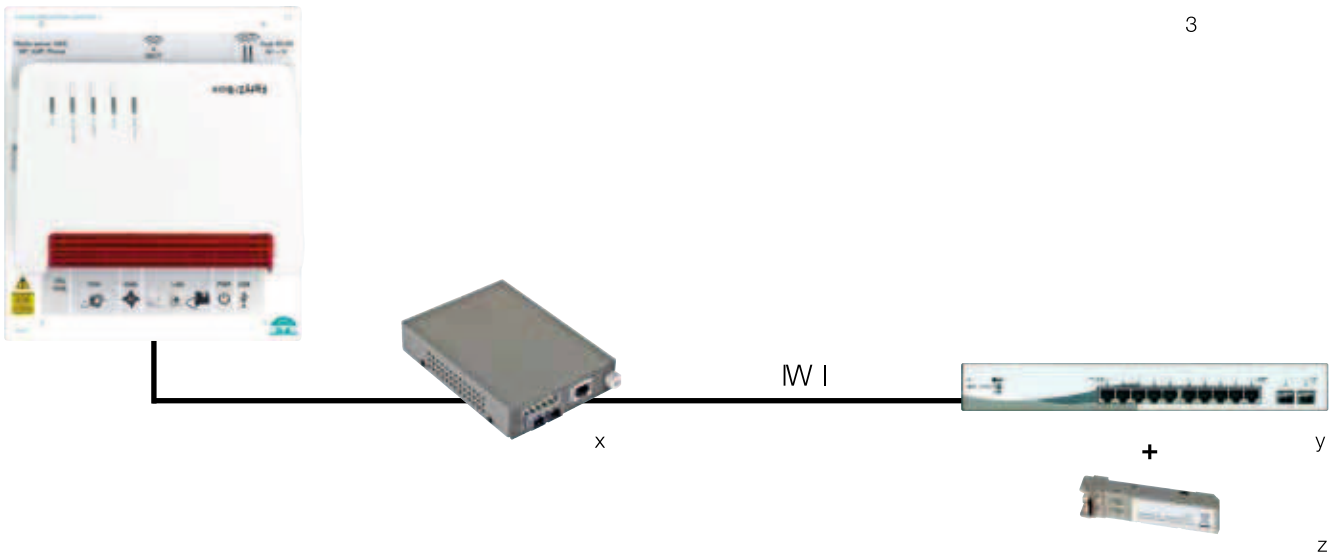

No.	Designation	Order No.
1	Fibre optic connector assembly tool set	41073
2	Fiber optic connector set	41072
3	Fiber optic cable set	41071
x	media converter	41063
y	switch manager with PoE	41062
z	IWI module sFP	41064

# FibeR oPtic cable

FibeRglass

stay connected  
with us on social media

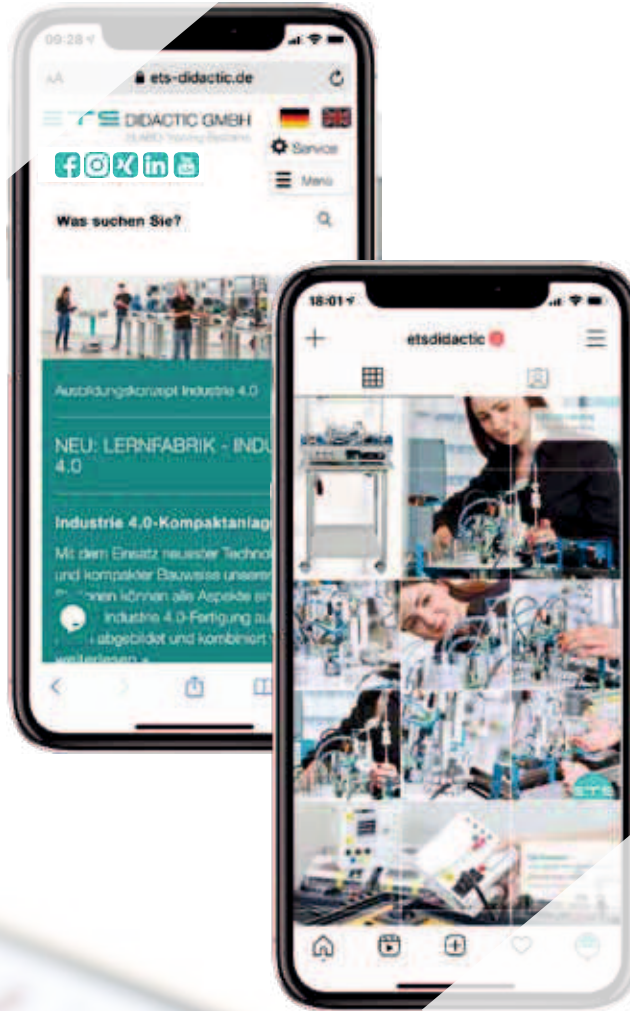





# didactic solution From ets

## Catalog „Configuration and Commissioning of KNX Systems“

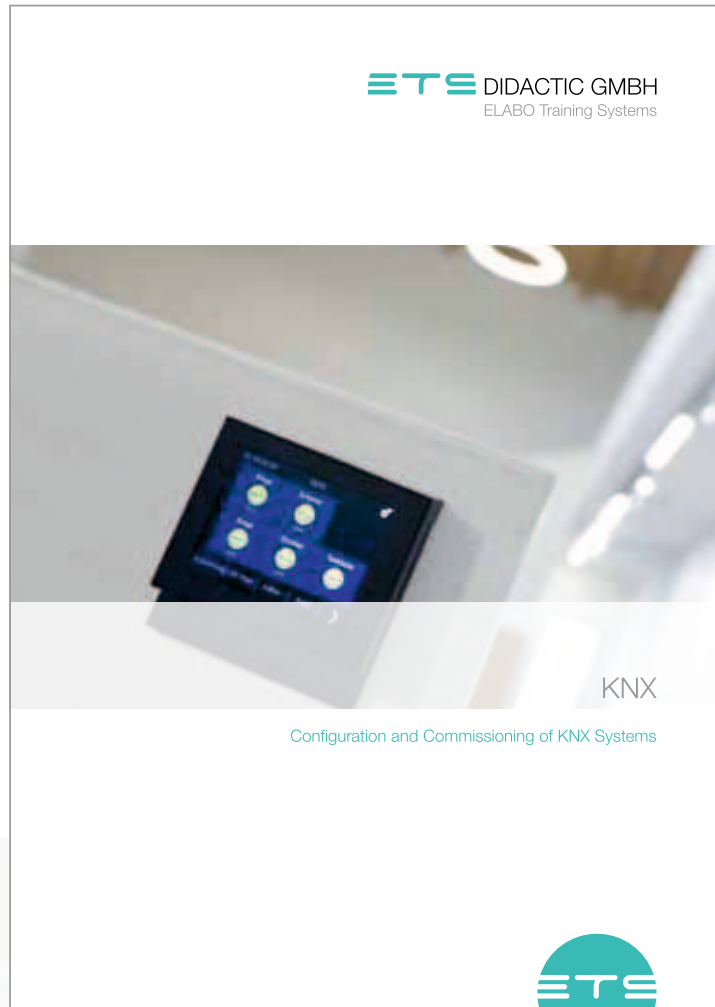



catalog „installation engineering – lighting technology“

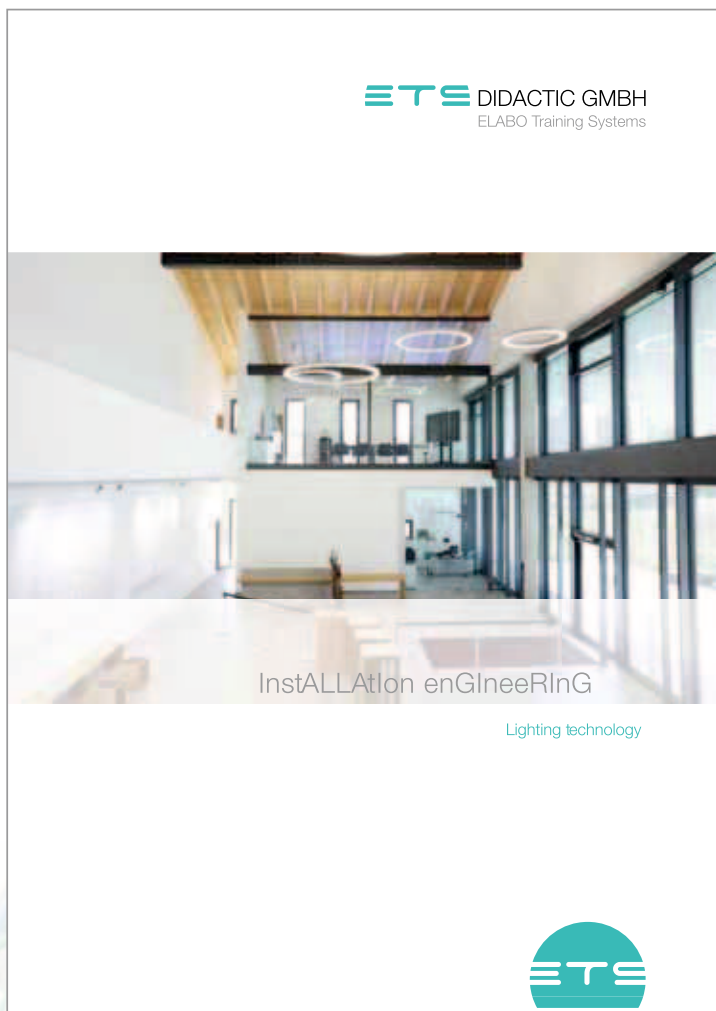



# Quality is the measure of all success

## inspiring technologies

ETS DIDACTIC GMBH is a symbol of high quality and outstanding flexibility. This means that ETS DIDACTIC products are convertible, they can – thanks to the modular conception and the versatile range of accessories – be quickly and efficiently matched to changed requirements and extended nearly without limits.

our high quality standards refer not only to the products from ets didactic, but especially also to the quality of the training that customers achieve thanks to the use of ets didactic products. and in this, we also include the process quality: ets didactic supports procedures during the training that are as problem-free as possible.

The solutions offered by ETS DIDACTIC can be matched to individual customer requirements to a great extent. customers of ets didactic are supported and accompanied in the successful implementation of their training objectives by a comprehensive range of services.





Please contact us

We are always ready to assist you



eva Pickl  
export assistant



monday to Friday from 7.45h to 16.30h

Phone: +49 8467 / 8404-0

email: [sales@ets-didactic.de](mailto:sales@ets-didactic.de)



We accompany you and are at your side with active advice. Whether you need information, or some advice in advance of making an investment, or have questions regarding the daily use of the products:

Contact us –  
we are ready to assist:

ets didactic gmbH  
service-center  
im Hüttental 11  
85125 Kinding / germany

Phone +49 8467 8404-0  
Fax +49 8467 8404-44

sales@ets-didactic.de  
www.ets-didactic.de



#### Customer-oriented solutions

- › Presentation, product demonstrations and on-site consultancy
- › support in the selection of educational systems according to the syllabus requirements
- › matching of the training systems to customer requirements
- › Working out room concepts
- › designing ergonomic workstations

#### Experience

- › comprehensive range of innovative products
- › systems and solutions from our own (in-house) production
- › development and design, technical training systems
- › Quality right from the consultancy up to delivery and onward
- › trainer workshops / in-house training / Webinars
- › References world-wide
  - industrial educational institutions
  - Vocational schools / technical schools
  - chambers of crafts
  - technical colleges / universities

#### We support you

- › installation and commissioning of the systems on-site
- › technical support
- › Warranty and repairs
- › instruction and training
- › Further education, training, seminars
- › comprehensive product documentation
- › courseware for instructors and trainees



Haussprech  
Intercom System / Vor





# youR inQuiR y

ets didactic gmbH

im Hüttental 11  
 85125 Kinding | germany  
 Phone +49 8467 8404-0  
 Fax +49 8467 8404-44

name, Function \_\_\_\_\_

company / institution / authority \_\_\_\_\_

street, P.o. box \_\_\_\_\_

Zip code, city \_\_\_\_\_

telephone \_\_\_\_\_ telefax \_\_\_\_\_

e-mail \_\_\_\_\_

**We would like:**

to be received by the following:

Qty.	Designation	Order No.	Qty.	Designation	Order No.
	bus audio indoor s tation	41077		telecommunication VoiP - commissioning/t rouble.	41082cd-eng-V2
	bus Video indoor s tation	41078		telecommunication VoiP - Presentation aids	41083cd-eng-V2
	Video outdoor s tation	41075		iP telefon Video	41061
	Video Power supply board	41076		information system - s tudent manual	42400-eng
	Video access gate	41079		information system - instructor's manual	42401-eng
	2 mm safety measuring lead set	90005		information system - commissioning/t roubl.	42402-eng
	set of ets ring binders	91093		information system - Presentation aids	42403-eng
	House intercom systems - instructor's manual	41095cd-eng		bst ® communications t echnologies i	43560
	House intercom systems - s tudent manual	41096cd-eng		bst ® communications t echnologies ii	41061-V2
	House intercom systems - Presentation aids	41098cd-eng		measuring receiver	43546
	tecHnoc ard® - bus Video Power supply board	41110-eng		network installation set	41070
	tecHnoc ard® - bus Video outdoor s tation	41111-eng		Patch Panel board	41055
	tecHnoc ard® - bus audio indoor s tation	41112-eng		communication systems - instructor's manual	43570cd -eng
	tecHnoc ard® - bus Video indoor s tation	41113-eng		communication systems - s tudent manual	43571cd -eng
	tecHnoc ard® - bus Video access gate	41114-eng		c ommunication systems - commissioning/t roubl.	43572cd -eng
	intercom main s ystem	41180		communication systems - Presentation a ids	43573cd -eng
	intercom sub s ystem	41181		tecHnoc ard® -bst ® communication t echnologies i	43574-eng
	install. House intercom- signal system instructor's m.	41185cd-eng		Fibre optic connector assembly tool set	41073
	install. House intercom- signal system s tudent m.	41186cd-eng		Fibre optic connector set	41072
	install. House intercom- signal system Present. aids	41188cd-eng		Fibre optic cable set	41071
	set tecHnoc ard®- House intercom	41189-eng		media converter	41063
	tecHnoc ard®- House intercom & signaling system	41190-eng		switch manager with Poe	41062
	tecHnoc ard®- House intercom Project 1	41191-eng		I WI module sFP	41064
	tecHnoc ard®- House intercom Project 2	41192-eng		bst ® communications t echnologies ii	43561
	tecHnoc ard®- House intercom Project 3	41193-eng		Patch Panel board	41055
	communication center ii	41057		"Koax" tool set	43563
	set of patch cables cat6 - 6 pcs	41056		measuring receiver	90255
	Patch Panel board	41055		signal generator	90251
	telecommunication VoiP - instructor's manual	41080cd-eng-V2		satellite system - digital	43562
	telecommunication VoiP - s tudent manual	41081cd-eng-V2		tecHnoc ard® -bst ® communication t echnologies ii	43579-eng







Scarica il catalogo completo



Cataloghi digitali, alberi felici:  
scegli **Abintrax** che con **mydidactstore**,  
abbraccia la sostenibilità!

Concessionario

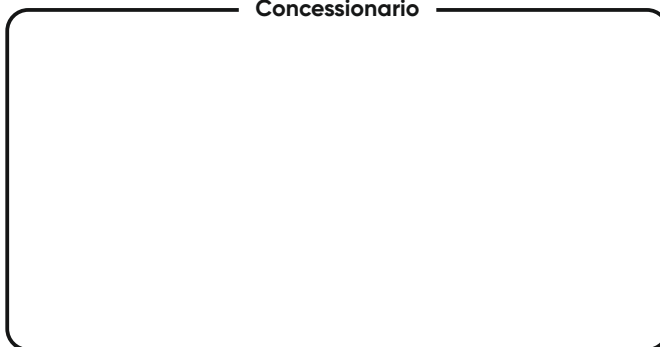

**Abintrax s.r.l.**  
Via Marina del Mondo, 62 | 70043 Monopoli (Ba) Italy  
tel. +39 080 2149700 | [www.abintrax.com](http://www.abintrax.com) | [info@abintrax.com](mailto:info@abintrax.com)

[www.mydidactstore.it](http://www.mydidactstore.it)